



LASERJET PRO MFP

Repair Manual



M521



HP LaserJet Pro MFP M521 Printer

Repair Manual

Copyright and License

© 2012 Copyright Hewlett-Packard Development Company, L.P.

Reproduction, adaptation, or translation without prior written permission is prohibited, except as allowed under the copyright laws.

The information contained herein is subject to change without notice.

The only warranties for HP products and services are set forth in the express warranty statements accompanying such products and services. Nothing herein should be construed as constituting an additional warranty. HP shall not be liable for technical or editorial errors or omissions contained herein.

Edition 1, 12/2012

Part number: A8P79-90904


Trademark Credits

Adobe®, Acrobat®, and PostScript® are trademarks of Adobe Systems Incorporated.


Microsoft®, Windows®, Windows® XP, and Windows Vista® are U.S. registered trademarks of Microsoft Corporation.

ENERGY STAR and the ENERGY STAR mark are registered U.S. marks.

Conventions used in this guide

 **TIP:** Tips provide helpful hints or shortcuts.

 **NOTE:** Notes provide important information to explain a concept or to complete a task.

 **CAUTION:** Cautions indicate procedures that you should follow to avoid losing data or damaging the product.


 **WARNING!** Warnings alert you to specific procedures that you should follow to avoid personal injury, catastrophic loss of data, or extensive damage to the product.

Table of contents

1 Removal and replacement	1
Removal and replacement strategy	2
General cautions during removal and replacement	2
Electrostatic discharge	2
Required tools	3
Types of screws	3
Service approach	5
Before performing service	5
After performing service	5
Post-service test	5
Print-quality test	5
Location of connectors	7
DC controller connections	7
Formatter connections	9
Parts removal order	10
Removal and replacement procedures	11
Customer self repair (CSR) assemblies	11
Toner cartridge	11
Tray 2 or Tray 3 assembly	13
Document feeder rollers	14
Document feeder pickup roller	14
Document feeder separation roller	16
Document feeder separation pad	17
External panels, covers, doors, and formatter	18
Formatter cover	18
Formatter PCA	19
Fax PCA and cable	20
Interconnect board (ICB)	21
Formatter stay	22
Dummy cover	23
Rear cover assembly	24
Left cover	28

Right-rear cover	30
Tray 1 cover	32
Cartridge-door assembly	34
Right cover assembly	36
Lower right cover	41
Reinstall the lower right cover	43
I/O plate	44
Document feeder assemblies and scanner	46
Document feeder/scanner assembly	46
Document feeder whole unit kit and scanner whole unit kit	52
Document feeder hinge assembly	57
Control-panel top-cover	57
Control-panel assembly	59
USB PCA	60
Control-panel FFC	61
USB cable and USB grounding cable	64
Wi-Fi module and cable	67
Main assemblies	71
Tray 1 pickup roller	71
Tray 1 separation pad	73
Tray 2 or Tray 3 pickup roller	74
Tray 2 or Tray 3 separation pad	76
Tray 2 or Tray 3 base-plate roller assembly	76
Transfer roller	78
Fuser	80
Duplex paper-feed assembly	83
Registration roller assembly	86
Power-switch assembly	88
Interlock-switch assembly	89
Tray sensor PCA	91
Main fan	93
Top cover	95
Laser scanner	98
Tag holder assembly	101
DC controller	102
Low-voltage power supply (LVPS)	106
Tray 2 paper pickup assembly	112
Tray 1 or Tray 2 pickup solenoid	118
Fuser motor	120
Pendulum assembly	121
Sub fan and fan duct	124

Environmental sensor	128
High-voltage power supply (HVPS)	130

2 Parts and diagrams 139

Order parts by authorized service providers	140
Order parts, accessories, and supplies	140
Supplies part numbers	140
Customer self-repair (CSR) and service kits	141
Related documentation and software	142
Fasteners used in this product	142
How to use the parts lists and diagrams	143
Assembly locations	143
Base product (no optional trays or accessories)	143
Base product (optional trays or accessories)	144
Covers	146
Document feeder and scanner assemblies	148
Control-panel and USB PCA assemblies	150
Document feeder assemblies	152
Internal assemblies (1 of 6)	154
Internal assemblies (2 of 6)	156
Internal assemblies (3 of 6)	158
Internal assemblies (4 of 6)	160
Internal assemblies (5 of 6)	162
Internal assemblies (6 of 6)	164
Input devices	166
500-sheet input tray (Tray 3)	166
Alphabetical parts list	168
Numerical parts list	172

Index 177

1 Removal and replacement

- [Removal and replacement strategy](#)
- [Service approach](#)
- [Removal and replacement procedures](#)


Removal and replacement strategy

General cautions during removal and replacement

This chapter describes the removal and replacement of field-replaceable units (FRUs) only.


Replacing FRUs is generally the reverse of removal. Occasionally, notes and tips are included to provide directions for difficult or critical replacement procedures.

HP does *not* support repairing individual subassemblies or troubleshooting to the component level.


 **WARNING!** Turn the product off, wait 5 seconds, and then remove the power cable before attempting to service the product. If this warning is not followed, severe injury can result, in addition to damage to the product. The power must be on for certain functional checks during troubleshooting. However, disconnect the power supply during parts removal.

Never operate or service the product with the protective cover removed from the laser scanner assembly. The reflected beam, although invisible, can damage your eyes.


The sheet-metal parts can have sharp edges. Be careful when handling sheet-metal parts.

 **CAUTION:** Do not bend or fold the flat flexible cables (FFCs) during removal or installation. Also, do not straighten prefolds in the FFCs. You *must* fully seat all FFCs in their connectors. Failure to fully seat an FFC into a connector can cause a short circuit in a PCA.



Incorrectly routed or loose wire harnesses can interfere with other internal components and can become damaged or broken. Frayed or pinched harness wires can be difficult to find. When replacing wire harnesses, always use the provided wire loops, lance points, or wire-harness guides and retainers.

 **NOTE:** To install a self-tapping screw, first turn it counterclockwise to align it with the thread pattern, and then carefully turn it clockwise to tighten. Do not overtighten. If a self-tapping screw-hole becomes stripped, repair the screw-hole or replace the affected assembly.

Note the length, diameter, color, type, and location of each screw. Be sure to return each screw to its original location during reassembly.

 **TIP:** For clarity, some photos in this chapter might show components removed that would not be removed to service the product. If necessary, remove the components listed at the beginning of a procedure before proceeding to service the product.

Electrostatic discharge

 **CAUTION:**  Some parts are sensitive to electrostatic discharge (ESD). Look for the ESD reminder when removing product parts. Always perform service work at an ESD-protected workstation or mat, or use an ESD strap. If an ESD workstation, mat, or strap is not available, ground yourself by touching the sheet-metal chassis *before* touching an ESD-sensitive part.

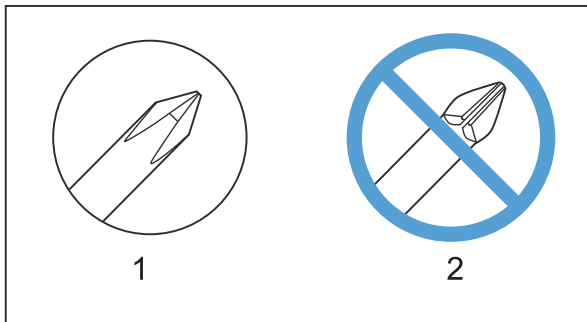
Protect the ESD-sensitive parts by placing them in ESD pouches when they are out of the product.

Required tools

- #2 Phillips 152 mm (6 in) screwdriver with magnetic tip
- #2 Phillips 76 mm (3 in) screwdriver with magnetic tip
- Small flat-tip screwdriver
- Small needle-nose pliers
- ESD mat
- Penlight

⚠ CAUTION: Always use a Phillips screwdriver (callout 1). Do not use a Pozidriv® screwdriver (callout 2) or any motorized screwdriver. These can damage screws or screw threads.

Figure 1-1 Phillips and Pozidriv screwdriver comparison



Types of screws

📝 NOTE: The illustration in this section are for reference only. The screws in your product might look slightly different.

Illustration	Description	Size	Part number	Use
	Screw	M3X6	0515-2908	Used to secure metal components to metal components (for example, a ground wire to the frame)
	Screw	M3X8	0515-4681	
	Screw, tapping	P-M3X6	0515-5621	
	Screw, tapping, truss head	M4X14	0515-4672	Used to secure anything to plastic

6 mm 8 mm 10 mm 14 mm M 3 M 4
|<=>| |<=>| |<=>| |<=>| ○ ○

Service approach

Product repair normally begins by using the product internal diagnostics and the following two-step process:

1. Isolate the problem to the major system (for example, the network, the server, or the product).
2. Troubleshoot the problem by using the procedures in the solve problems chapter of the Troubleshooting Manual.

After you find a faulty part, the product can usually be repaired at the assembly level by replacing field-replaceable units (FRUs). Some mechanical assemblies might need to be repaired at the subassembly level.

Before performing service

- Remove all paper from the product.
- Turn off the power using the power switch.
- Disconnect the power cable and interface cable or cables.
- Place the product on an ESD workstation or mat, or use an ESD strap (if one is available). If an ESD workstation, mat, or strap is not available, ground yourself by touching the sheet-metal chassis *before* touching an ESD-sensitive part.
- Remove the toner cartridges. See [Toner cartridge on page 11](#).
- Remove the tray or trays. See [Tray 2 or Tray 3 assembly on page 13](#).

After performing service

- Connect the power cable.
- Reinstall the toner cartridges.
- Reinstall the tray or trays.
- If an optional paper feeder was installed, place the product on the feeder.

Post-service test

Perform the following test to verify that the repair or replacement was successful.

Print-quality test

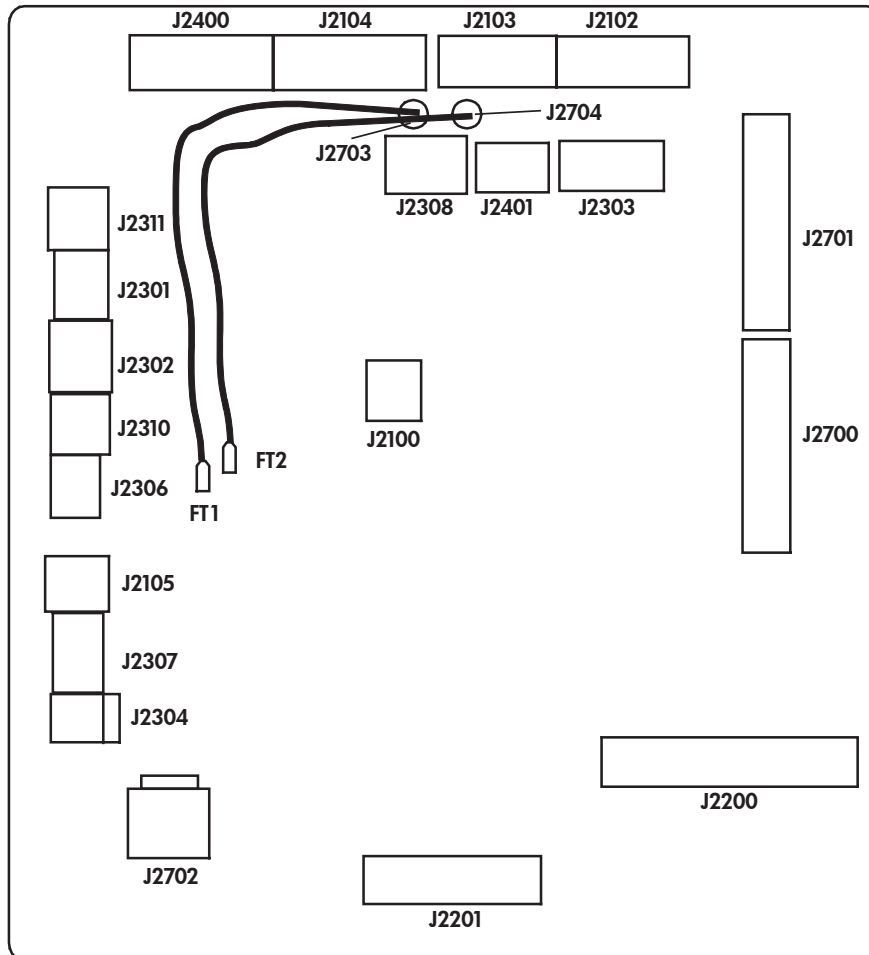
1. Verify that you have completed the necessary reassembly steps.
2. Make sure that the tray contains clean, unmarked paper.
3. Attach the power cable and interface cable or interface cables, and then turn on the product.
4. Verify that the expected start-up sounds occur. The fans start.

5. Print a configuration page, and then verify that the expected printing sounds occur. The fans start and the rollers turn.
6. Print a demo page, and then verify that the print quality is as expected.
7. Send a print job from the host computer, and then verify that the output meets expectations.
8. If necessary, restore any customer-specified settings.
9. Clean the outside of the product with a damp cloth.

Location of connectors

DC controller connections

Figure 1-2 DC controller connections

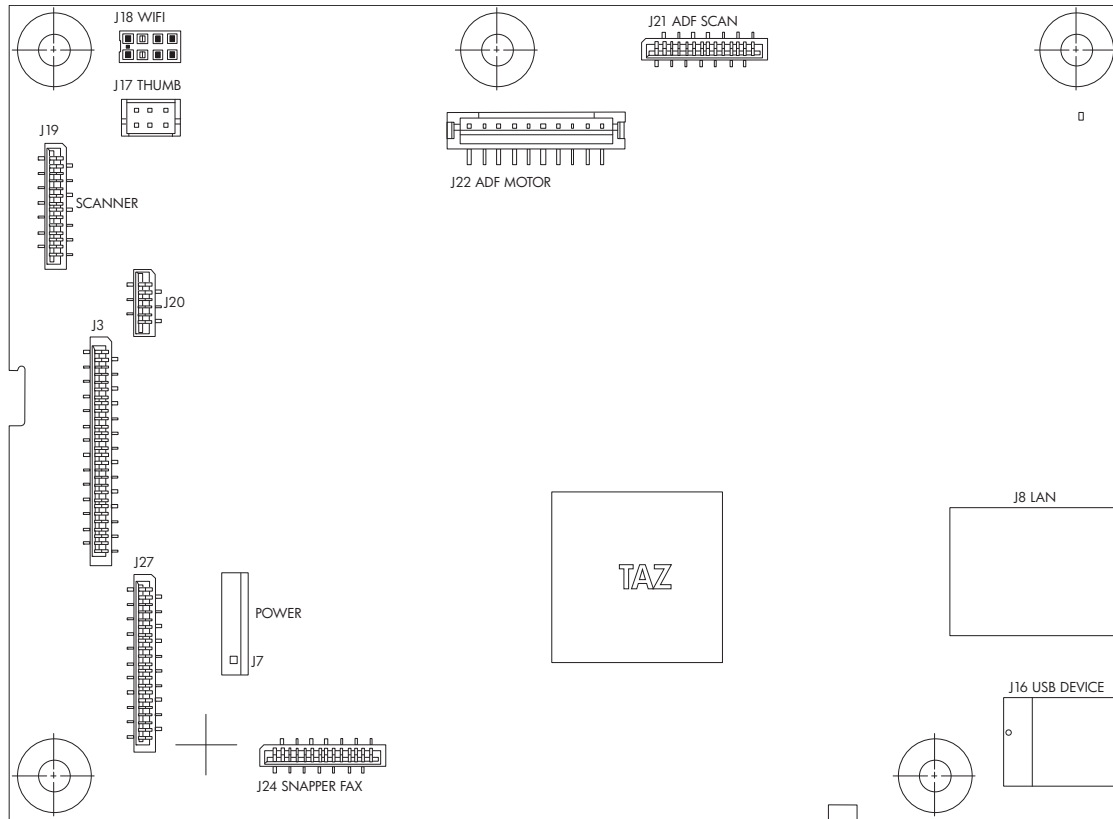


Item	Description	Item	Description	Item	Description
J2100	Not used	J2302	MPT paper out sensor (PS205)	J2400	Fuser output sensor (PS2) TH1/TH2
J2102	Fuser motor (M8002)	J2303	Face-up sensor (PS1) Output bin full sensor (PS4)	J2401	
J2103	Main motor (M8003)	J2304	Environmental sensor (TH3)	J2700	LVPS

Item	Description	Item	Description	Item	Description
J2104	Subfan (FM2) Rear door sensor (PS8001) Scanner motor (M3)	J2306	Interlock-switch (SW260)	J2701	LVPS
J2105	Power switch (SW240)	J2307	Tray detection switch (SW235)	J2702	LVPS
J2200	HVPS	J2308	Main fan (FM1)	J2703	Cartridge door switch (SW501)
J2201	Paper feeder connector	J2310	CST pickup solenoid (SL2)	J2704	Cartridge door switch (SW501)
J2301	CST paper out sensor (PS3)	J2311	MPT pickup solenoid (SL1)		

Formatter connections

Figure 1-3 Formatter connections



Item	Description	Item	Description
J3	Control panel	J19	Flatbed scanner
J7	Power	J20	Flatbed motor
J8	LAN	J21	ADF/Scanner
J16	USB Device	J22	ADF motor
J17	USB	J24	Snapper Fax
J18	Wifi	J27	Video

Parts removal order

Figure 1-4 Parts removal order: covers and customer-replaceable assemblies

1. covers and customer replaceable assemblies								
Assembly	Remove	Remove	Remove	Remove	Remove	Remove	Remove	Remove
Toner cartridge								
Tray 2,3								
Formatter cover								
Formatter PCA	Formatter cover							
ICB	Formatter cover							
Fax card and cable	Formatter cover							
Dummy cover	Formatter cover							
Rear cover assy								
Left cover	Rear cover assy							
Right-rear cover	Formatter cover	Rear cover assy						
Tray 1 cover								
Cartridge-door assy	Rear cover assy	Left cover	Tray 1 cover					
Right cover	Formatter cover	Tray 1 cover (could choose not remove)	Cartridge-door assy (could choose not remove, only open)	ADF/Scanner assy				
Lower right cover	Dummy cover			ADF/Scanner assy				Right cover
Top cover	Rear cover assy	ADF/Scanner assy						
	Left cover							
I/O Plate	Formatter cover	Formatter PCA (ICB Fax card)	Formatter Stay (sheet metal)	I/O Plate assembly				
ADF pickup & separation roller								

2. ADF/Scanner assembly				
Assembly	Remove	Remove	Remove	Remove
Control Panel top cover				
Control Panel sub cover	Control Panel top cover			
Control Panel	Control Panel top cover	Control Panel sub cover		
USB PCA	Control Panel top cover	USB bracket (sheet metal)		
Control Panel FFC cable		Scanner lower cover	Control Panel top cover	Control Panel sub cover
USB cable & grounding cable	Formatter cover	Scanner lower cover	Control Panel top cover	
	Dummy cover			
Wifi module and cable	Rear cover assy	Scanner lower cover		
	Left cover			
ADF whole unit	ADF/Scanner assy	Scanner rear cover		
Scanner whole unit		Scanner rear cover		
ADF hinge assembly				

3. Main assemblies								
Assembly	Remove	Remove	Remove	Remove	Remove	Remove	Remove	Remove
Tray 1 pickup roller								
Tray 1 separation pad								
Tray 2, 3 pickup roller								
Tray 2, 3 separation pad								
Tray 2, 3 base-plate roller assy								
Transfer roller								
Fuser	Rear cover assy	Right-rear cover						
Duplex media-feed assy	Rear cover assy	Right-rear cover						
Registration roller assy	Rear cover assy	Left cover						
Power-switch assy		Tray 1 cover	Cartridge-door assy	Right cover				
Interlock switch assy		Tray 1 cover	Cartridge-door assy	Right cover				
Tray sensor PCA		Tray 1 cover	Cartridge-door assy	Right cover				
Main fan	Formatter cover	Tray 1 cover	Cartridge-door assy	Right cover				
DC controller	Dummy cover	Tray 1 cover	Cartridge-door assy	Right cover				
	Rear cover assy				Lower right cover (if removing sheet metal plate)			
Top cover	Left cover	ADF/Scanner assy						
Laser scanner		ADF/Scanner assy	Top cover					
Tag holder assy		ADF/Scanner assy	Top cover					
LVPS (Low-voltage power supply)		Right cover	Lower right cover	ADF/Scanner assy	Top cover	DC controller	LVPS	
Tray 1, 2 pickup solenoid	Formatter cover	Right cover	Lower right cover	ADF/Scanner assy	Top cover	DC controller	LVPS	
	Dummy cover							
Fuser motor	Rear cover assy	Right cover	Lower right cover	ADF/Scanner assy	Top cover	DC controller	LVPS	
Pendulum assy		Right cover	Lower right cover	ADF/Scanner assy	Top cover	DC controller	LVPS	Fuser motor
Sub fan and fan duct	Left cover	Right cover	Lower right cover	ADF/Scanner assy	Top cover	DC controller	LVPS	
	Right-rear cover							
Environmental sensor	Tray 1 cover	Right cover	Lower right cover	ADF/Scanner assy	Top cover	DC controller with plate	LVPS	
	Cartridge-door assy							
Tray 2 paper pickup		Duplex media-feed assy	Right cover	Lower right cover	ADF/Scanner assy	Top cover	DC controller	LVPS
		Duplex media-feed assy	Right cover	Lower right cover	ADF/Scanner assy	Top cover	DC controller	LVPS
HVPS								

Removal and replacement procedures

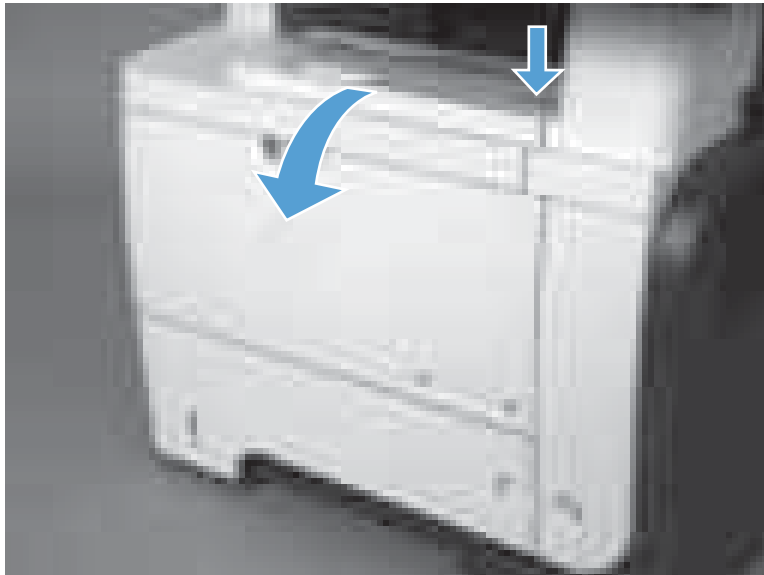
Customer self repair (CSR) assemblies

Toner cartridge

⚠ CAUTION: If toner gets on your clothing, wipe it off with a dry cloth and wash clothing in cold water. *Hot water sets toner into fabric.*

1. Press the cartridge-door release button, and then open the cartridge door. Make sure that the door is completely open.

Figure 1-5 Remove the toner cartridge (1 of 2)



2. Grasp the toner-cartridge handle and pull it out of the product.


⚠ CAUTION: Do not touch the green roller. Doing so can damage the cartridge. Do not expose the cartridge to strong light. Cover the cartridge with a sheet of paper to protect it from light.

💡 Reinstallation tip Align the toner cartridge with its slot and insert the toner cartridge until it clicks into place.

Figure 1-6 Remove the toner cartridge (2 of 2)



Tray 2 or Tray 3 assembly

 **NOTE:** Use this procedure to remove the Tray 2 or Tray 3 assembly.

- ▲ Pull the tray straight out of the product until it stops. Carefully lift up on the tray to release it, and then remove the tray.

Figure 1-7 Remove the tray



Document feeder rollers

Document feeder pickup roller

CAUTION: Do not touch the surface of the roller. Skin oils deposited on the roller might cause print-quality problems.

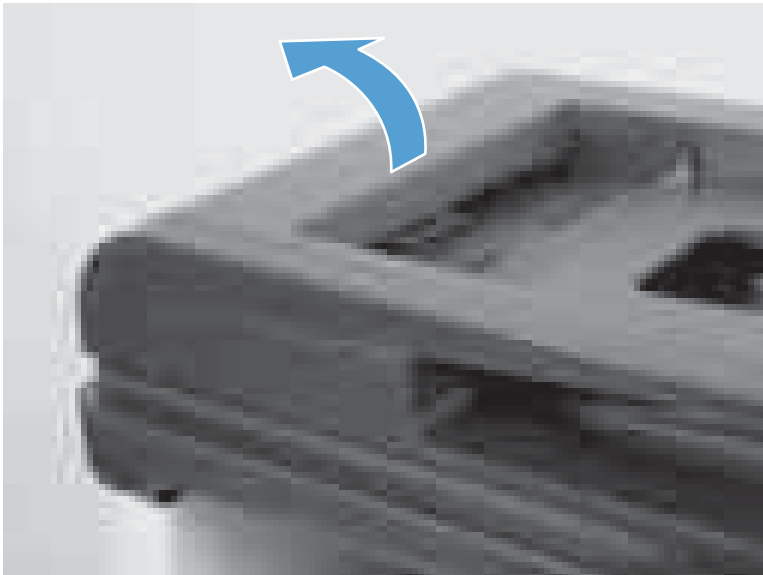
NOTE: If you did not remove Tray 2 or 3 before servicing the product, remove them now.

1. Carefully place the product front-side up, so that you can see into the opening where the tray would be installed.

NOTE: Debris can scratch or damage the back of the product. Before you place the product front-side up, remove any debris from the work surface. If possible, set the product on a clean, dry cloth to prevent scratching and damage.

2. Open the document feeder cover.

Figure 1-8 Remove the document feeder pickup roller (1 of 2)



3. Release one tab, and then rotate the roller out and away from the product to remove it.


 **TIP:** It might be easier to release the tab by using a small flat-tip screwdriver.

Figure 1-9 Remove the document feeder pickup roller (2 of 2)



Document feeder separation roller

CAUTION: Do not touch the surface of the roller. Skin oils deposited on the roller might cause print-quality problems.

1. Open the document feeder cover.

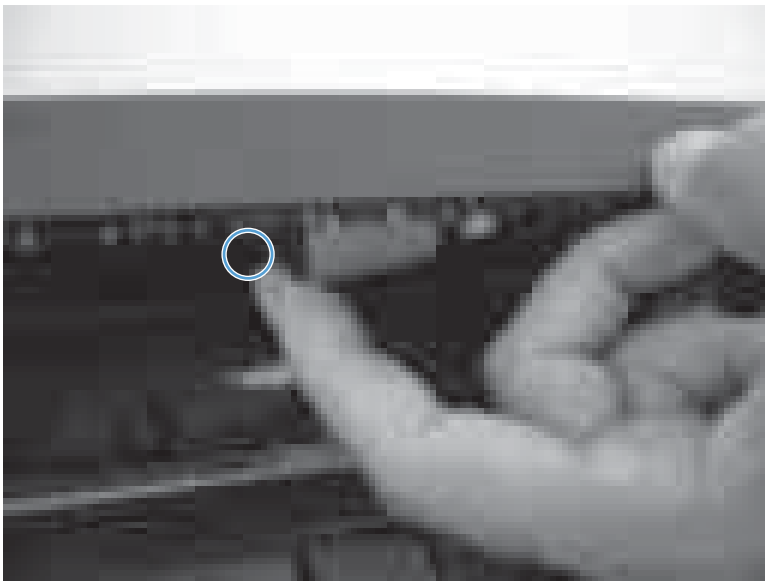
Figure 1-10 Remove the document feeder separation roller (1 of 2)



2. Release one tab, and then rotate the roller out and away from the product to remove it.

TIP: It might be easier to release the tab by using a small flat-tip screwdriver.

Figure 1-11 Remove the document feeder separation roller (2 of 2)

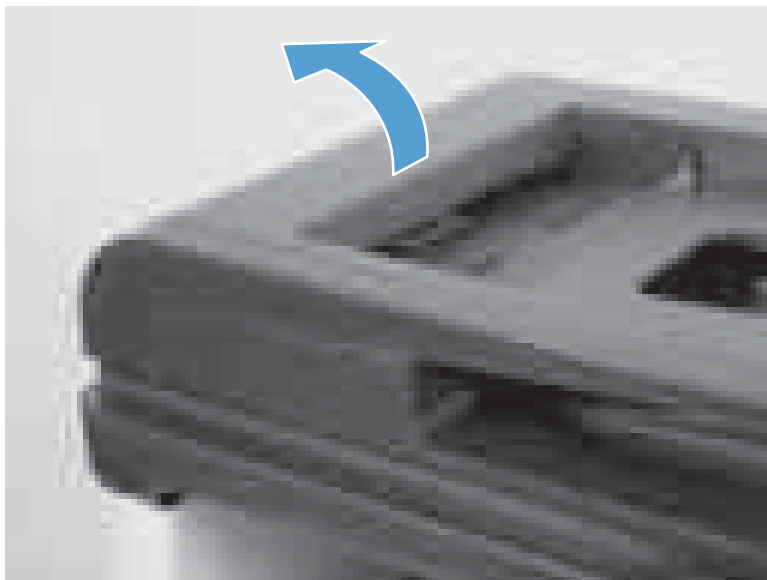


Document feeder separation pad

⚠ CAUTION: Do not touch the surface of the pad. Skin oils deposited on the roller might cause paper-handling problems.

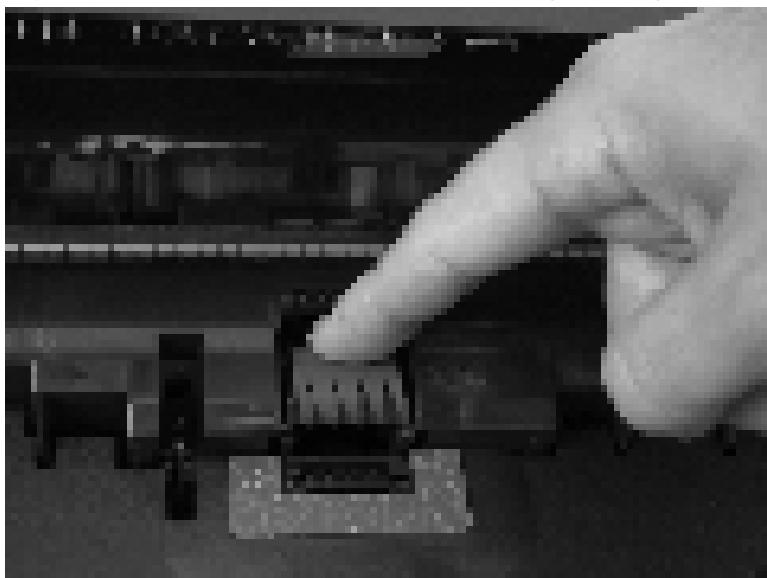
1. Open the document feeder cover.

Figure 1-12 Remove the document feeder separation pad (1 of 2)



2. Press down on the document feeder separation pad to release the pad, and then remove the separation pad.

Figure 1-13 Remove the document feeder separation pad (2 of 2)



External panels, covers, doors, and formatter

Formatter cover

- ▲ Slide the formatter cover toward the rear of the product to remove.

Figure 1-14 Remove the formatter cover



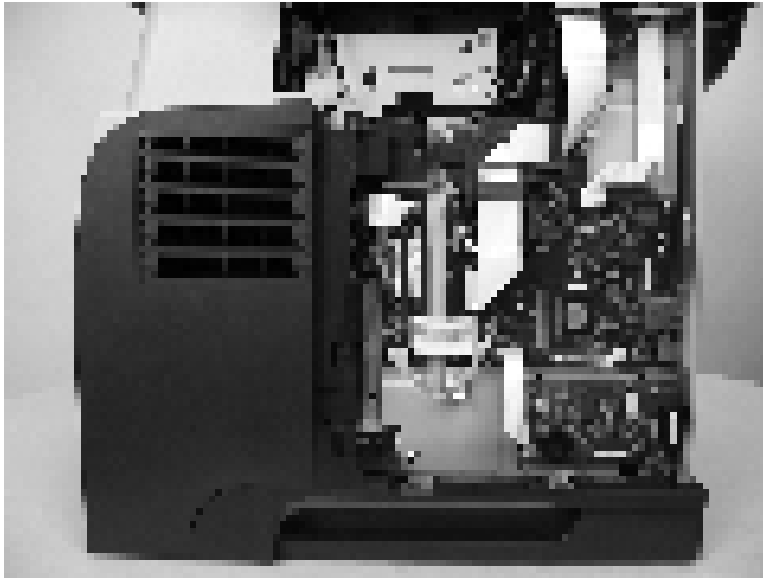
Formatter PCA

⚠ WARNING!  ESD sensitive component.

1. Before proceeding, remove the following:
 - Formatter cover. See [Formatter cover on page 18](#).
2. Disconnect 10 cables/FFCs (M521dw) or 9 cables/FFCs (M521dn).

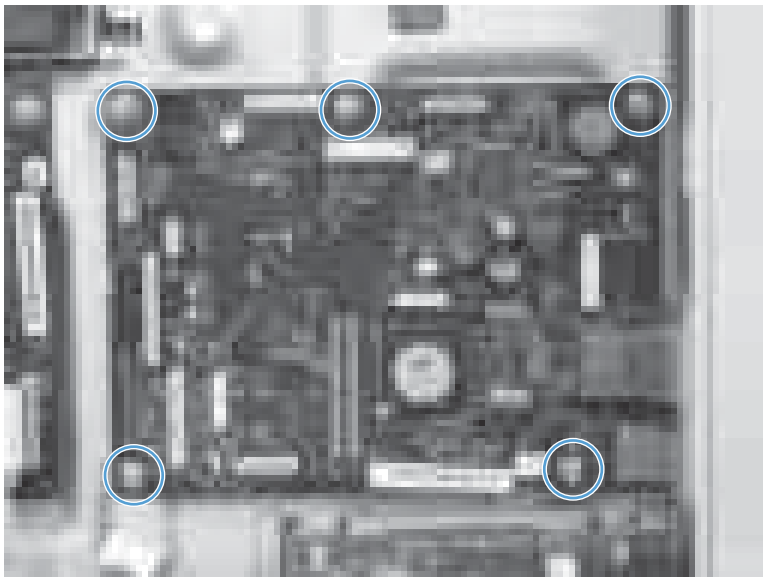
📝 NOTE: To locate the formatter connector locations, see [Formatter connections on page 9](#).

Figure 1-15 Remove the formatter PCA (1 of 2)



3. Remove five screws and then carefully remove the formatter PCA.

Figure 1-16 Remove the formatter PCA (2 of 2)

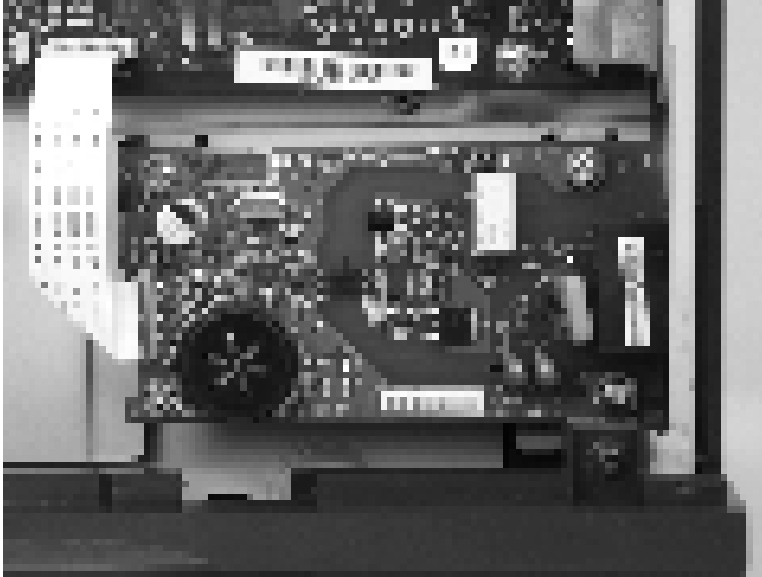


Fax PCA and cable

⚠ WARNING!  ESD sensitive component.

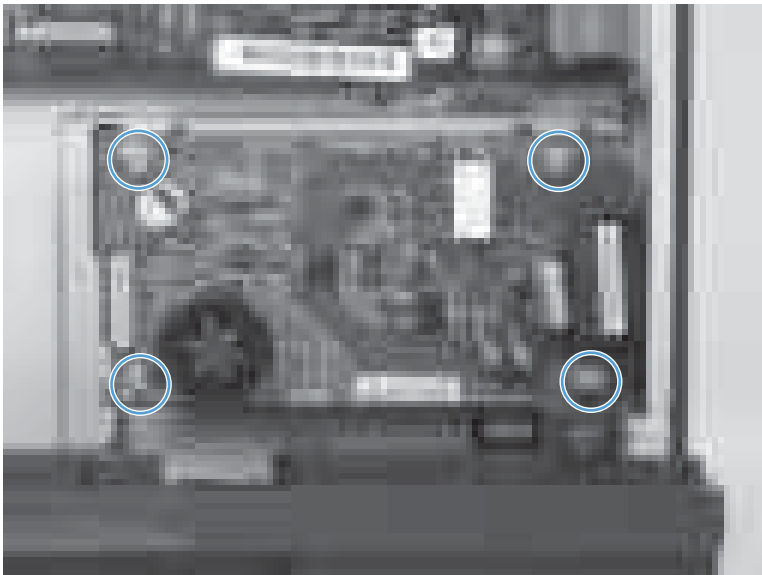
1. Before proceeding, remove the following:
 - Formatter cover. See [Formatter cover on page 18](#).
2. Disconnect one connector on the fax PCA.

Figure 1-17 Remove the fax PCA and cable (1 of 2)



3. Remove four screws, and then remove the fax PCA from the product.

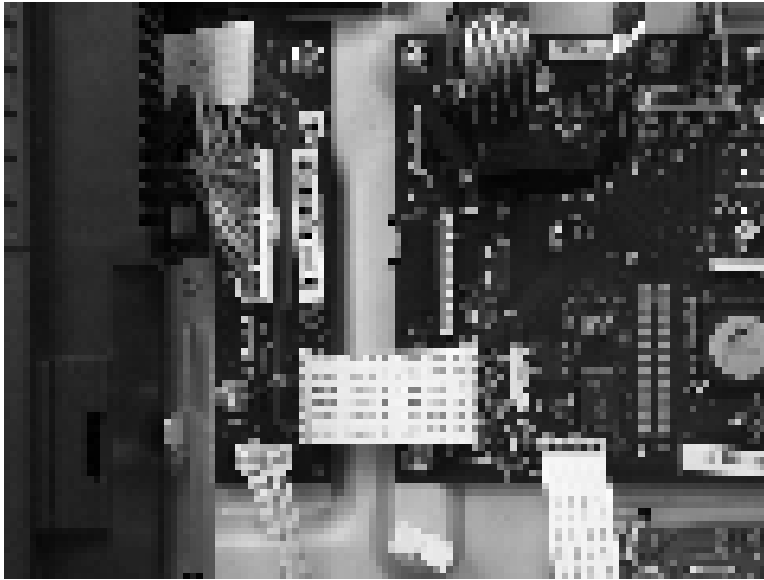
Figure 1-18 Remove the fax PCA and cable (2 of 2)



Interconnect board (ICB)

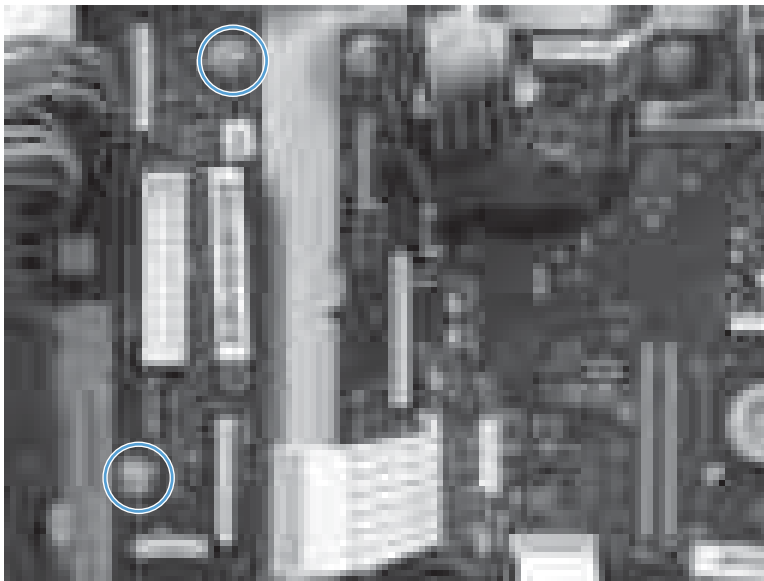
1. Disconnect two FFCs and two connectors.

Figure 1-19 Remove the ICB (1 of 2)



2. Remove two screws.

Figure 1-20 Remove the ICB (2 of 2)

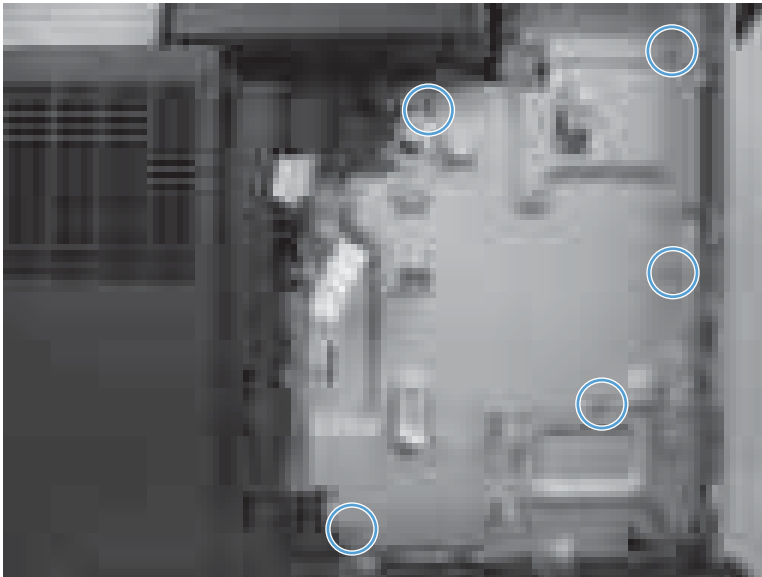


3. Remove the ICB.

Formatter stay

1. Before proceeding, remove the following:
 - Formatter cover. See [Formatter cover on page 18](#).
 - Formatter PCA. See [Formatter PCA on page 19](#).
 - Fax PCA and cable. See [Fax PCA and cable on page 20](#).
 - ICB. See [Interconnect board \(ICB\) on page 21](#).
2. Remove five screws holding the formatter stay to the chassis.

Figure 1-21 Remove the formatter stay, 1 of 1

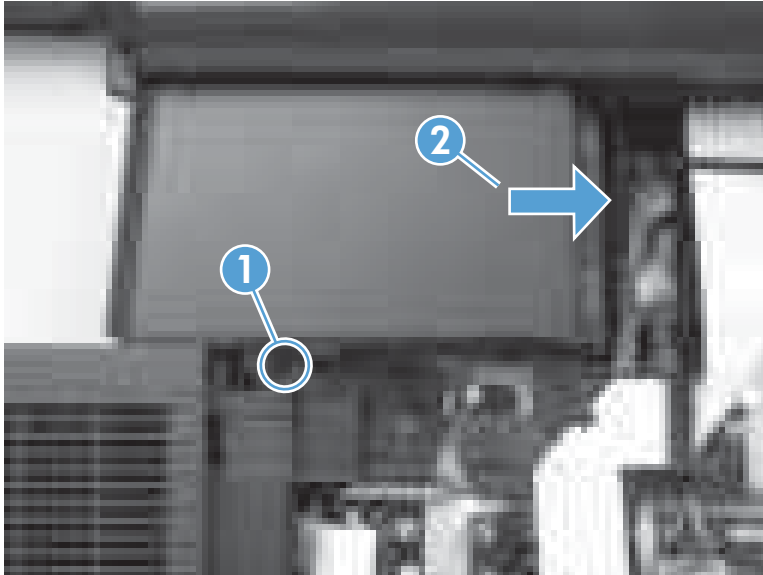


3. Remove the formatter stay.

Dummy cover

1. Before proceeding, remove the following components:
 - Formatter cover. See [Formatter cover on page 18](#).
2. Remove one screw (callout 1) and release one tab (callout 2).

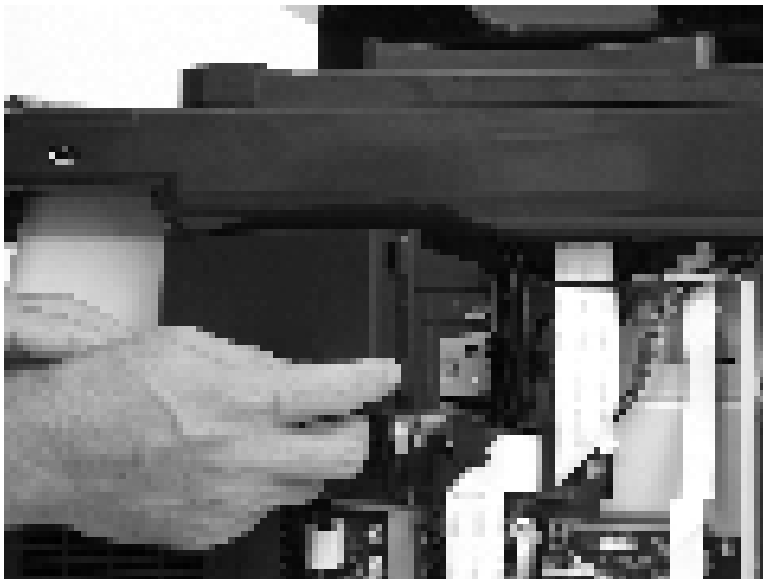
Figure 1-22 Remove the dummy cover (1 of 2)



 **Reinstallation tip** Disconnect the control-panel cable from the formatter to provide additional access to the tab.

3. Remove the dummy cover.

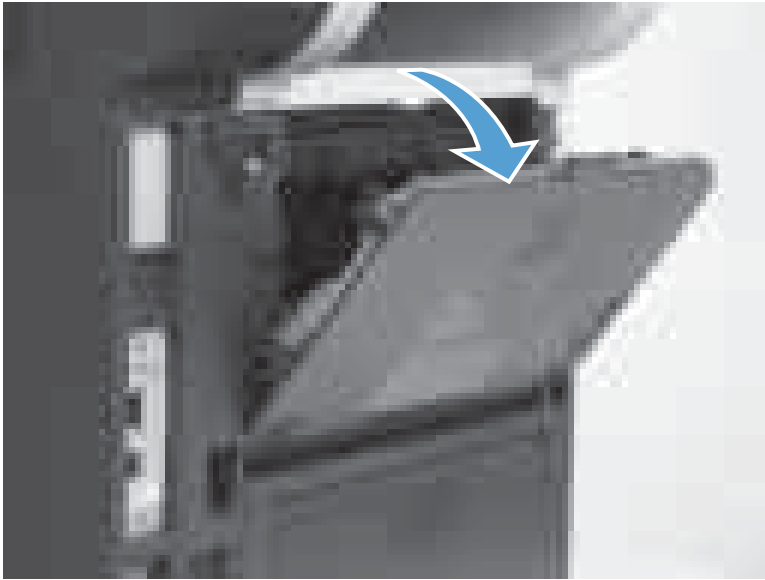
Figure 1-23 Remove the dummy cover (2 of 2)



Rear cover assembly

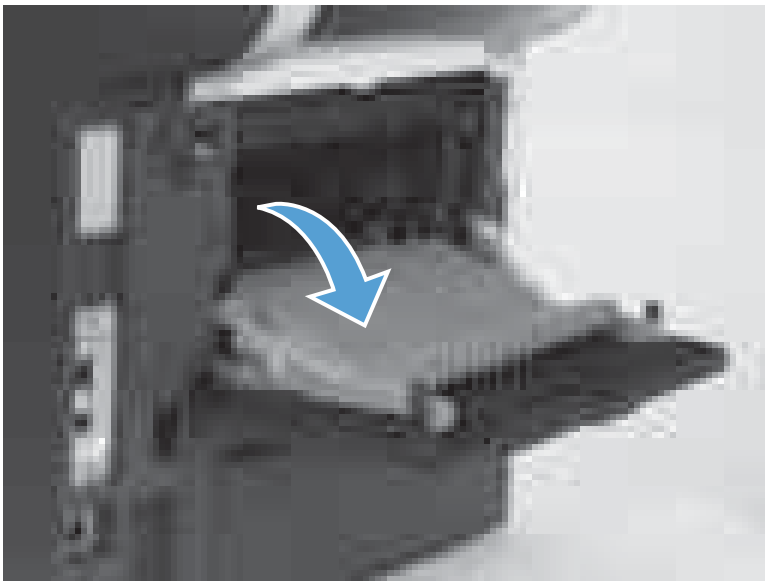
1. Open the rear door.

Figure 1-24 Remove the rear cover assembly (1 of 8)



2. Gently pull down on the door and lower the door until it is fully open.

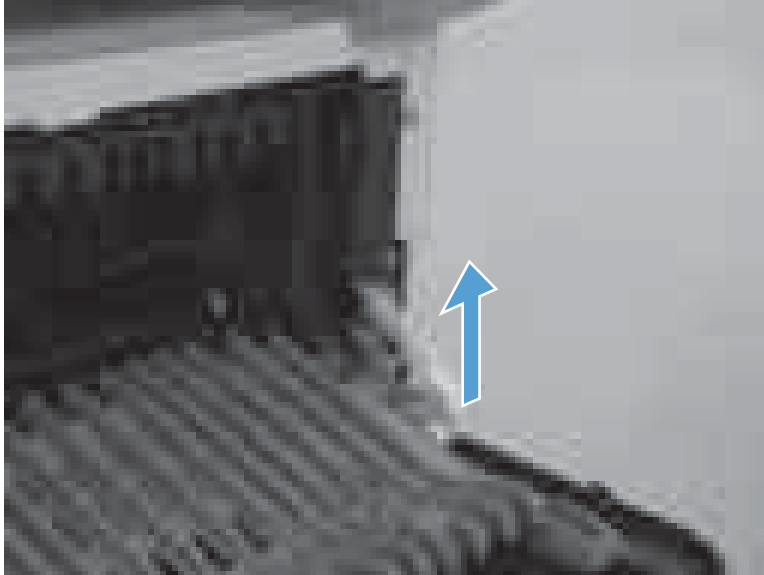
Figure 1-25 Remove the rear cover assembly (2 of 8)



3. Push up on the link arm to release it.

⚠ CAUTION: The link arm is under spring tension. Do not let the link arm snap back toward the product when you release it.

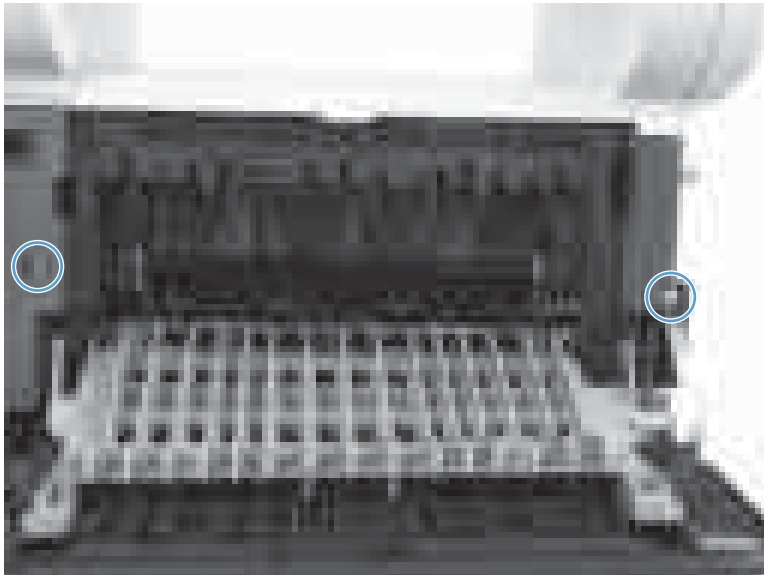
Figure 1-26 Remove the rear cover assembly (3 of 8)



4. Remove two screws.

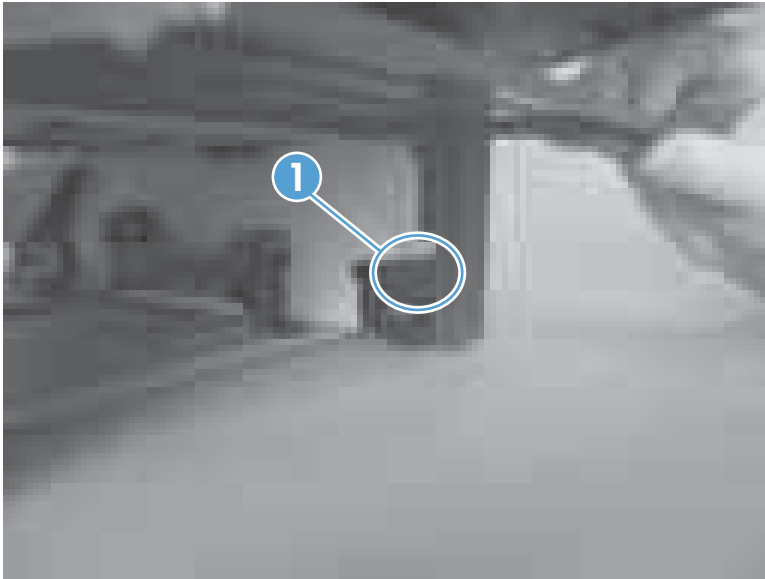
📝 NOTE: These two screws are of different types. Make sure to install them in the correct location.

Figure 1-27 Remove the rear cover assembly (4 of 8)



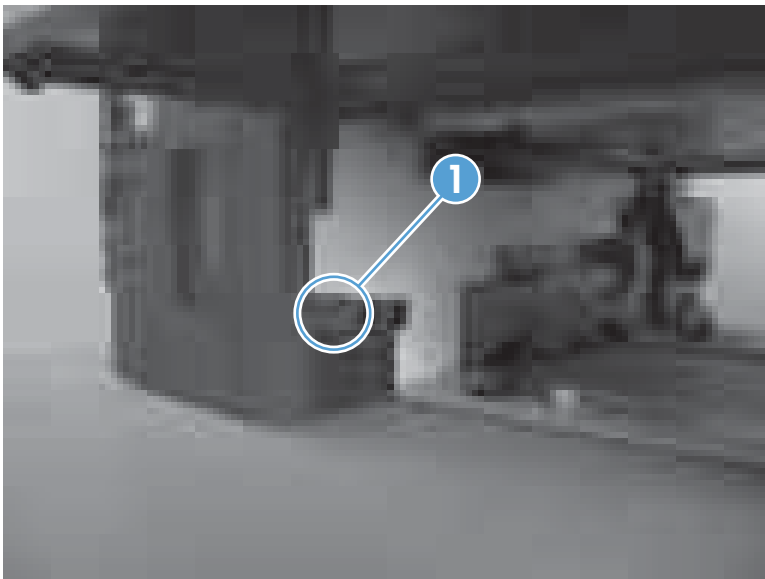
5. Open the lower-rear door, and then release one tab (callout 1).

Figure 1-28 Remove the rear cover assembly (5 of 8)



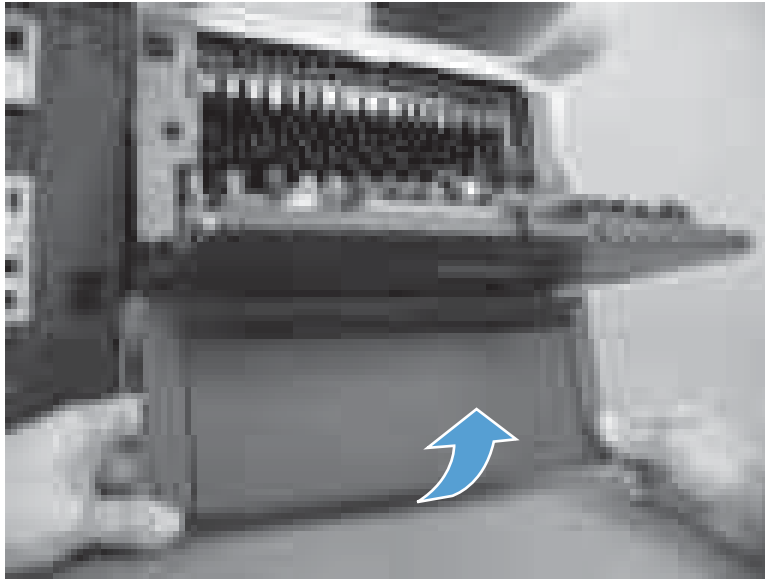
6. Release one tab (callout 1).

Figure 1-29 Remove the rear cover assembly (6 of 8)



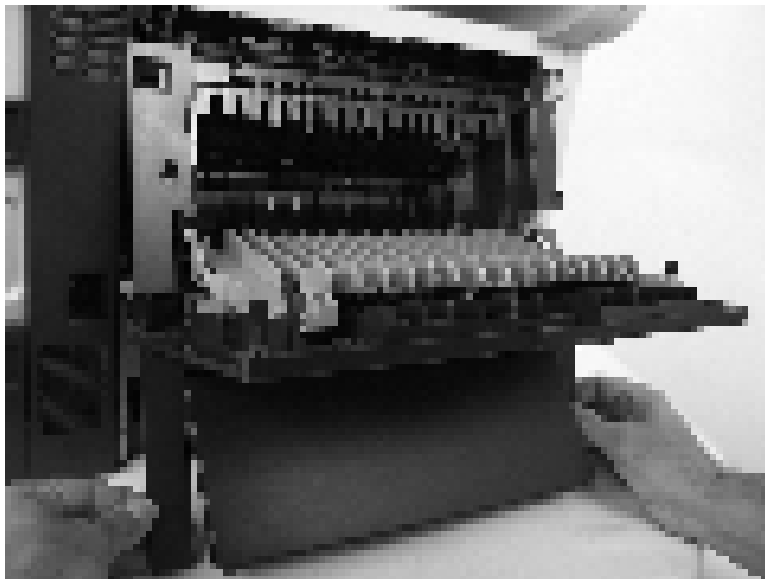
7. Rotate the bottom of the rear cover assembly away from the product.


Figure 1-30 Remove the rear cover assembly (7 of 8)



8. Pull down on the rear cover assembly to remove it.

Figure 1-31 Remove the rear cover assembly (8 of 8)

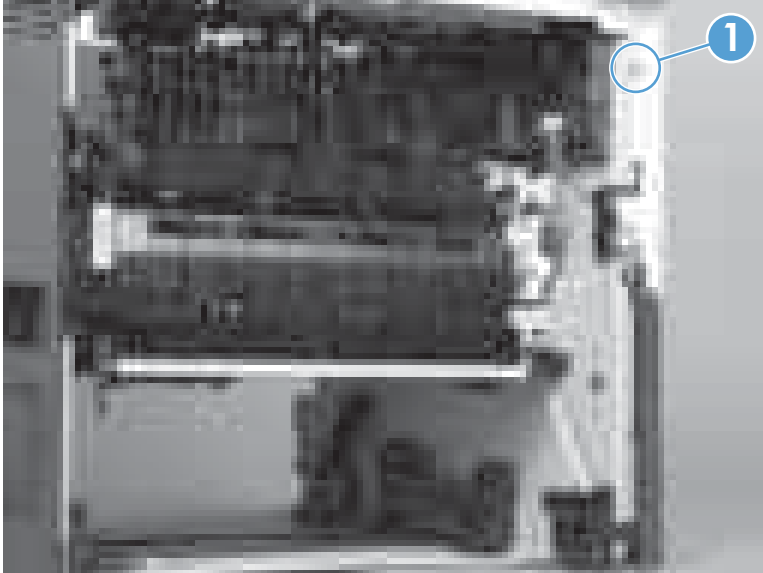


 **Reinstallation tip** Insert the top of the cover first to make sure the tabs are in place and then rotate the bottom of the cover into place.

Left cover

1. Before proceeding, remove the following:
 - Rear cover assembly. See [Rear cover assembly on page 24](#).
2. Remove one screw (callout 1).

Figure 1-32 Remove the left cover (1 of 3)



3. Grip the cover and pull it away from the product. Release the first tab (callout 1), and then release the second tab (callout 2). Release the third tab (callout 3), if necessary, to separate the cover from the product.


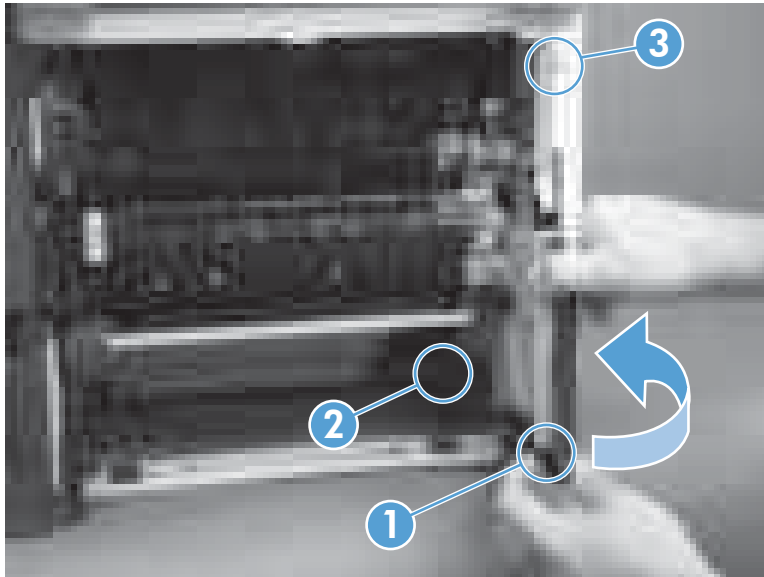
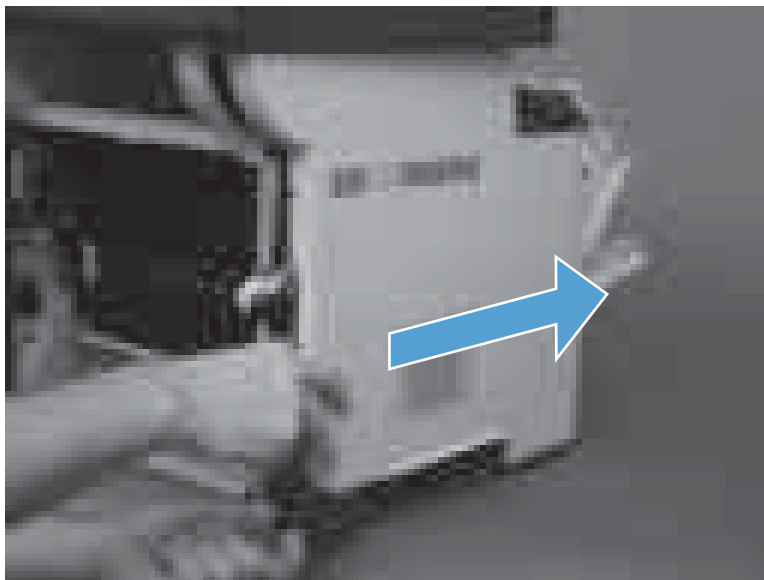
 **TIP:** The tab inside the tray cavity (callout 2) is located below the plastic tray rail. It might be easier to slightly lift up the left side of the product, and use a small flat-tip screwdriver to release this tab.


Figure 1-33 Remove the left cover (2 of 3)



4. Rotate the rear of the cover slightly away from the product, and then slide the cover toward the front of the product to remove it.

Figure 1-34 Remove the left cover (2 of 3)

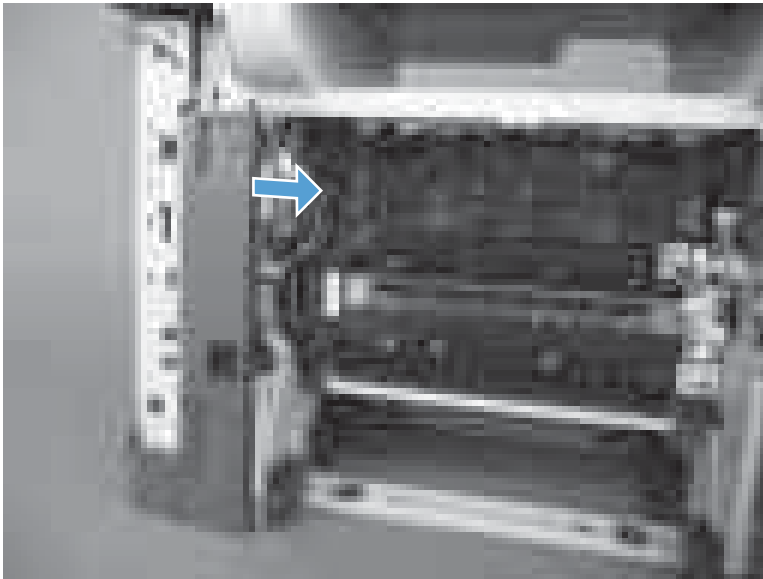


 **Reinstallation tip** Align the tabs on the front of the cover first and then reinstall the cover.

Right-rear cover

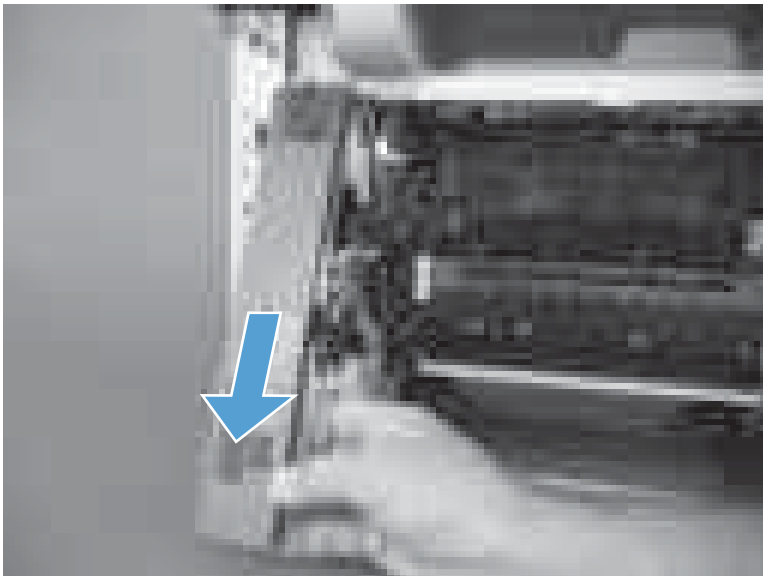
1. Before proceeding, remove the following:
 - Formatter cover. See [Formatter cover on page 18](#).
 - Rear cover assembly. See [Rear cover assembly on page 24](#).
2. Slide the right-rear cover toward the inside of the product to release it.

Figure 1-35 Remove the right-rear cover (1 of 2)



3. Rotate the bottom of the cover away from the product, and then pull down on the cover to remove it.

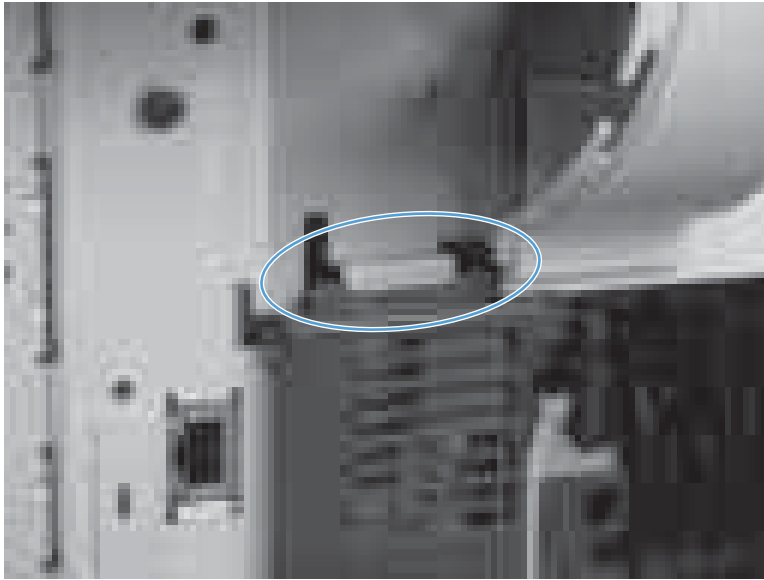
Figure 1-36 Remove the right-rear cover (2 of 2)



Reinstall the right-rear cover

- ▲ Make sure to slide the tab on the top of the cover under the sheet-metal clip.

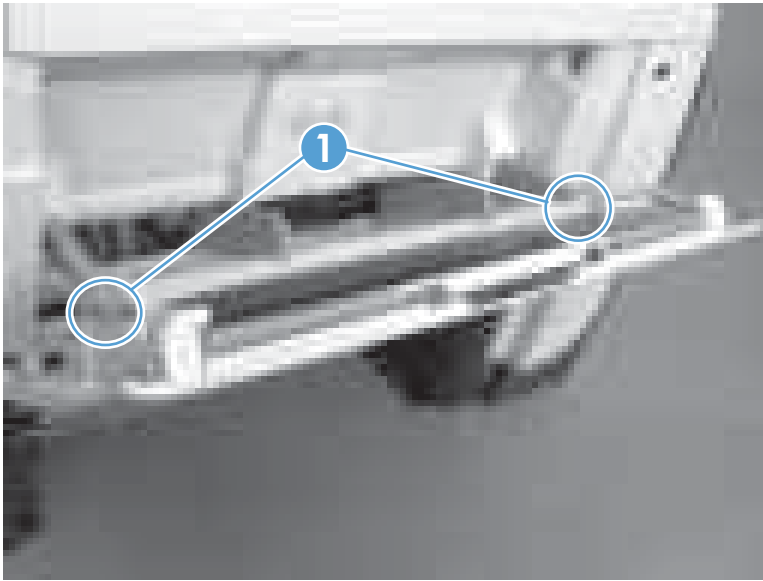
Figure 1-37 Reinstall the right-rear cover



Tray 1 cover

1. Before proceeding, remove the following:
 - Rear cover assembly. See [Rear cover assembly on page 24](#).
 - Left cover. See [Left cover on page 28](#).
2. Carefully release two retaining arms (callout 1).

Figure 1-38 Remove Tray 1 cover (1 of 3)



3. Slightly lift the cover to a 45 degree angle, and then slide it toward the left side of the product.


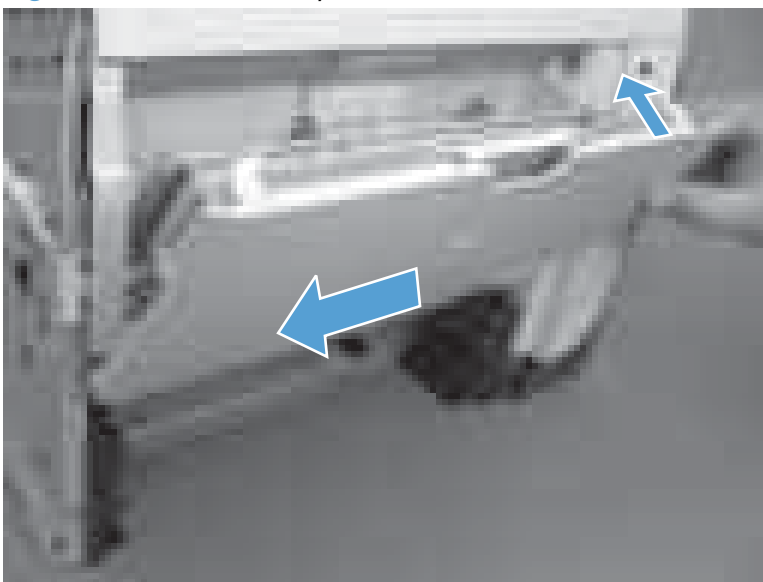
 **TIP:** If you lower the tray too far, it will not slide off of the hinge pins.

Figure 1-39 Remove Tray 1 cover (2 of 3)




4. Remove the Tray 1 cover.

Figure 1-40 Remove Tray 1 cover (3 of 3)



Cartridge-door assembly

1. Before proceeding, remove the following:
 - Rear cover assembly. See [Rear cover assembly on page 24](#).
 - Left cover. See [Left cover on page 28](#).
 - Tray 1 cover. See [Tray 1 cover on page 32](#).

 **TIP:** The cartridge-door assembly can be removed without removing the Tray 1 cover. However, it is easier to remove and reinstall the door assembly when the Tray 1 cover is not installed.

2. Remove one spring (callout 1).

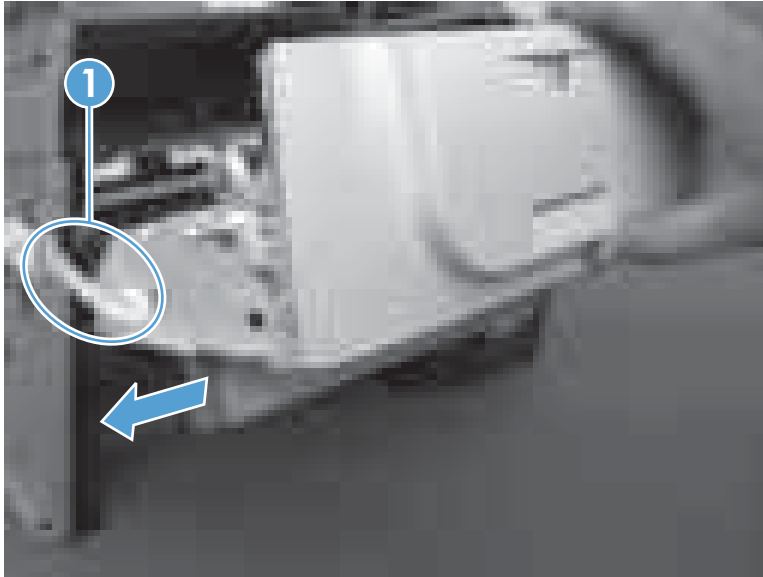
Figure 1-41 Remove the cartridge-door assembly (1 of 3)



3. Open the cartridge door slightly and then slide the assembly toward the left side of the product to release it from the hinge pins.

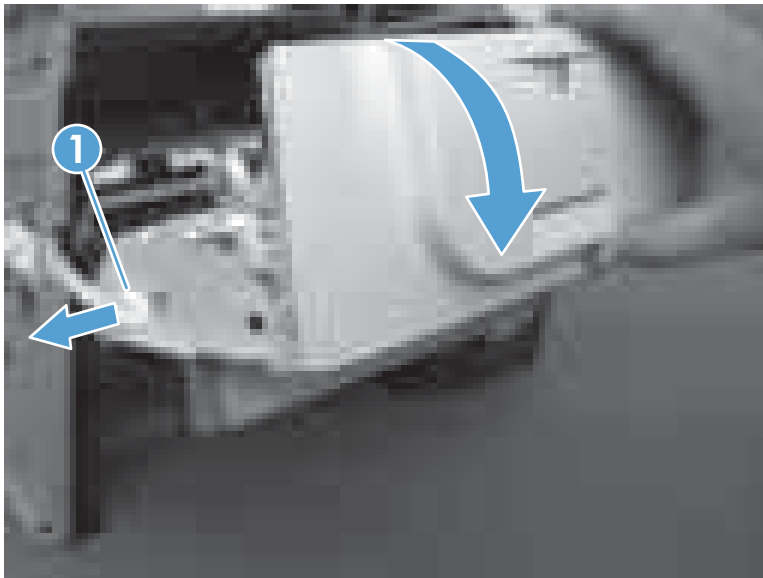
⚠ CAUTION: You can flex the link arm (callout 1), but be careful not to damage it.

Figure 1-42 Remove the cartridge-door assembly (2 of 3)



4. After releasing from the hinge pins, move the cartridge door to the right to release the pressure on the link arm. Rotate the assembly down, and then separate the link arm (callout 1) from the assembly. Remove the cartridge-door assembly.

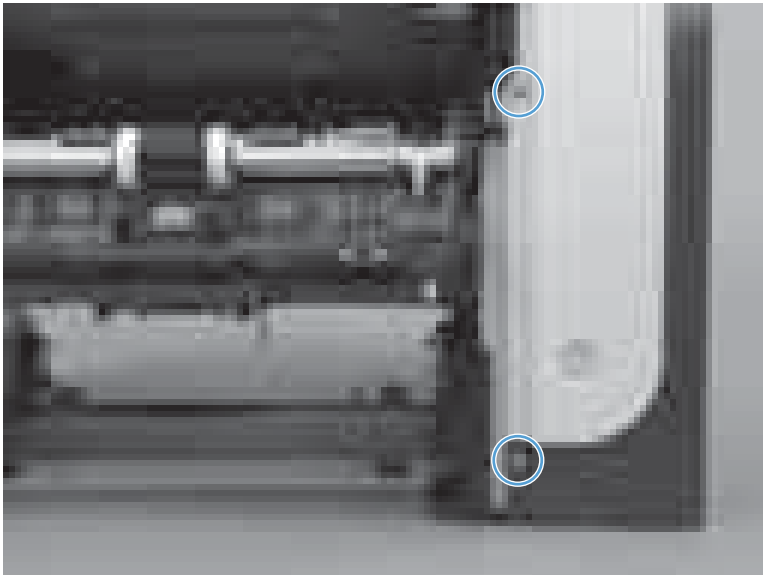
Figure 1-43 Remove the cartridge-door assembly (3 of 3)



Right cover assembly

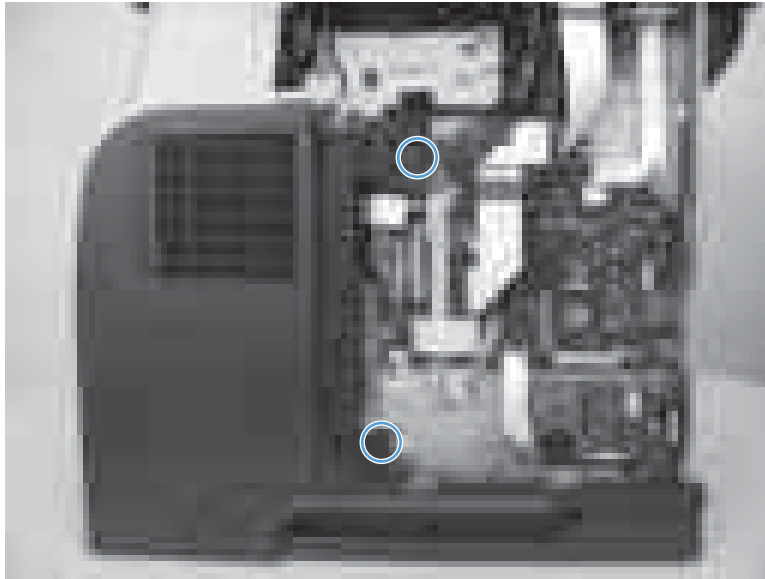
1. Before proceeding, remove the following:
 - Formatter cover. See [Formatter cover on page 18](#).
 - Dummy cover. See [Dummy cover on page 23](#)
 - Rear cover assembly. See [Rear cover assembly on page 24](#).
 - Left cover. See [Left cover on page 28](#).
 - Document feeder/scanner assembly. See [Document feeder/scanner assembly on page 46](#).
 - Tray 1 cover. See [Tray 1 cover on page 32](#).
 - Cartridge-door assembly. See [Cartridge-door assembly on page 34](#).
2. Remove two screws on the front of the product.

Figure 1-44 Remove the right cover assembly (1 of 5)



3. Remove two screws on the right-side of the product.

Figure 1-45 Remove the right cover assembly (2 of 5)



4. Remove one screw from the upper-right side of the product.

Figure 1-46 Remove the right cover assembly (3 of 5)

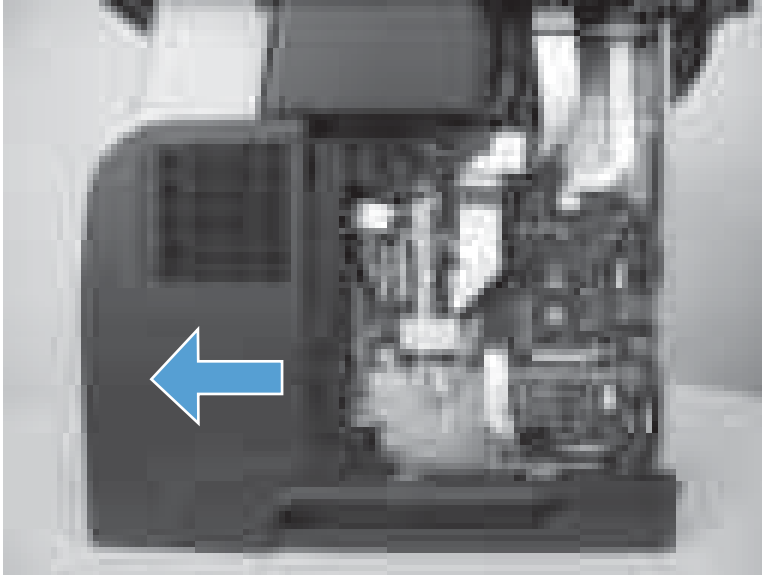


5. Release one tab, and then slide the cover toward the front of the product to remove.

⚠ CAUTION: Do not damage the covers or the cartridge-door assembly (if you did not remove it) when you remove the cover from the product.

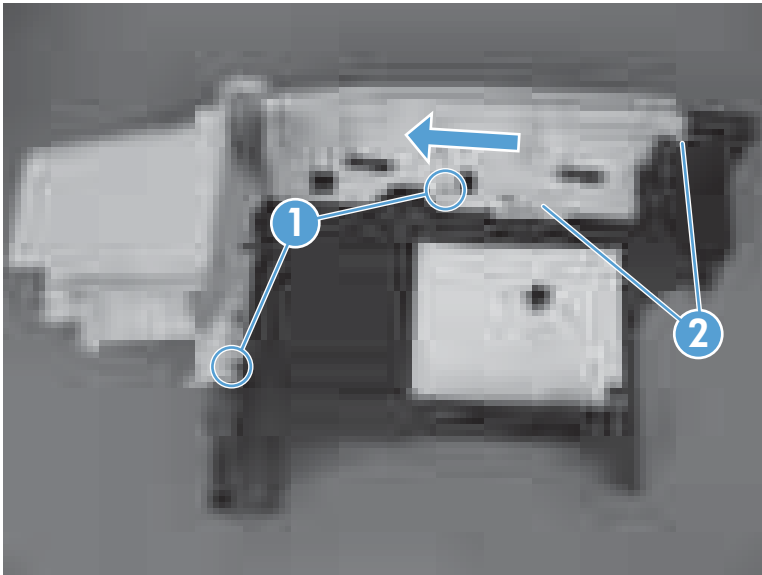
Do not dislodge the power-switch assembly when you rotate the cover assembly away from the product.

Figure 1-47 Remove the right cover assembly (4 of 5)



6. If necessary, remove two screws (callout 1), release two tabs (callout 2), and then slide the front-right cover toward the top of the right-side cover to release it.

Figure 1-48 Remove the right cover assembly (5 of 5)



Reinstall the right cover

1. Slide the cover onto the product from the front. Make sure the cover is aligned correctly at the top. The top of the cover should slide over the chassis, and the lower section of the cover should slide behind the chassis.

Figure 1-49 Reinstall the right cover assembly: correct alignment (1 of 3)

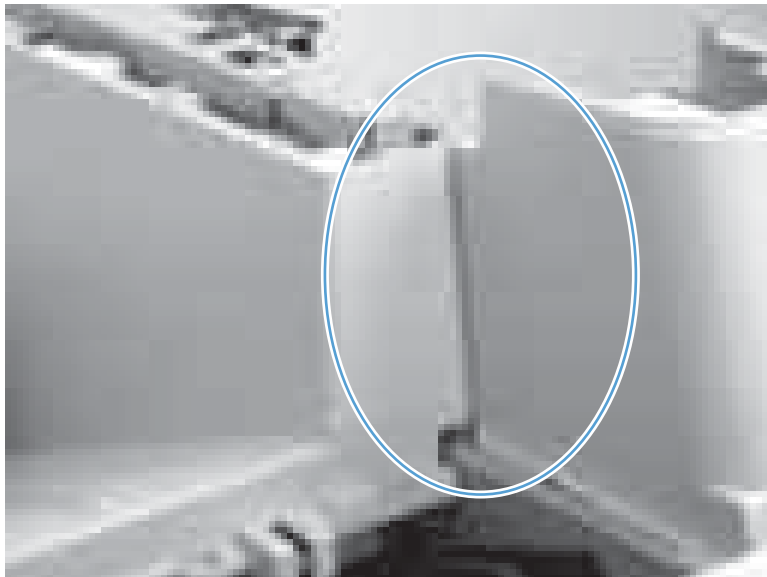
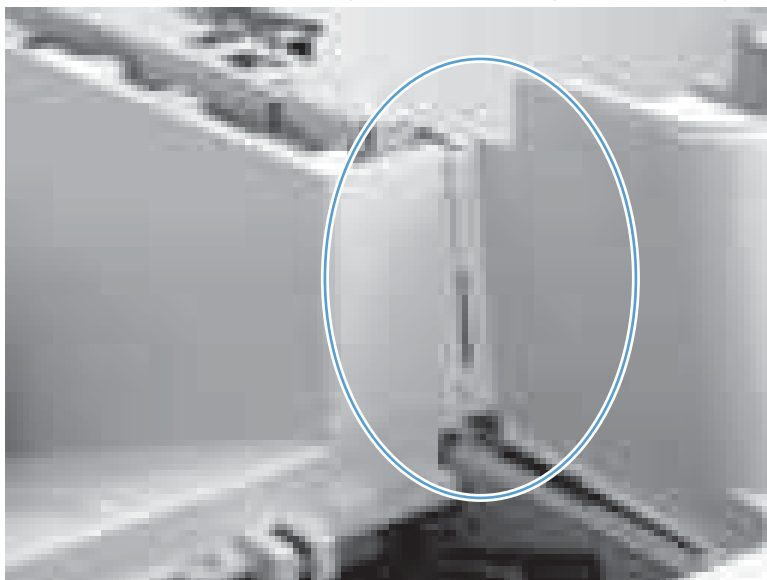
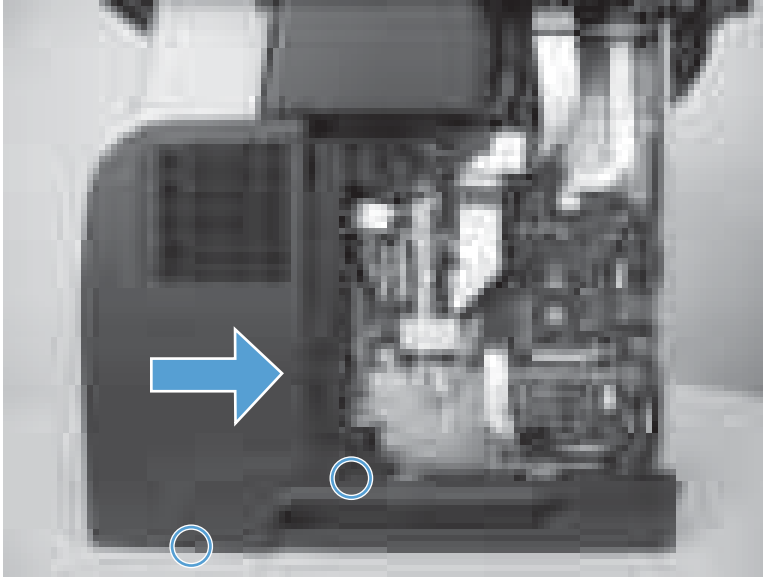


Figure 1-50 Reinstall the right cover assembly: incorrect alignment (2 of 3)



2. Make sure the two tabs are securely inserted.

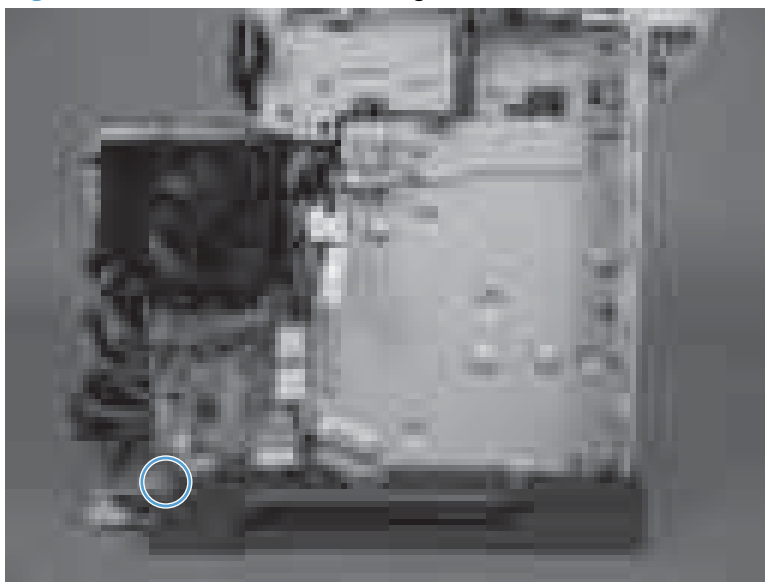
Figure 1-51 Reinstall the right cover assembly (3 of 3)



Lower right cover

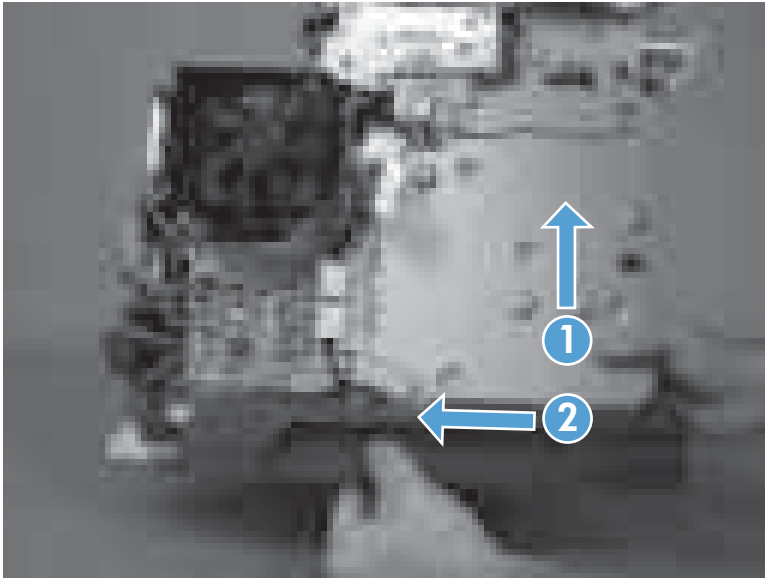
1. Before proceeding, remove the following:
 - Formatter cover. See [Formatter cover on page 18](#).
 - Formatter PCA. See [Formatter PCA on page 19](#).
 - Rear cover assembly. See [Rear cover assembly on page 24](#).
 - Left cover. See [Left cover on page 28](#).
 - Right-rear cover. See [Right-rear cover on page 30](#).
 - Tray 1 cover. See [Tray 1 cover on page 32](#).
 - Cartridge-door assembly. See [Cartridge-door assembly on page 34](#).
 - Right cover assembly. See [Right cover assembly on page 36](#).
2. Remove one screw.

Figure 1-52 Remove the lower right cover (1 of 3)



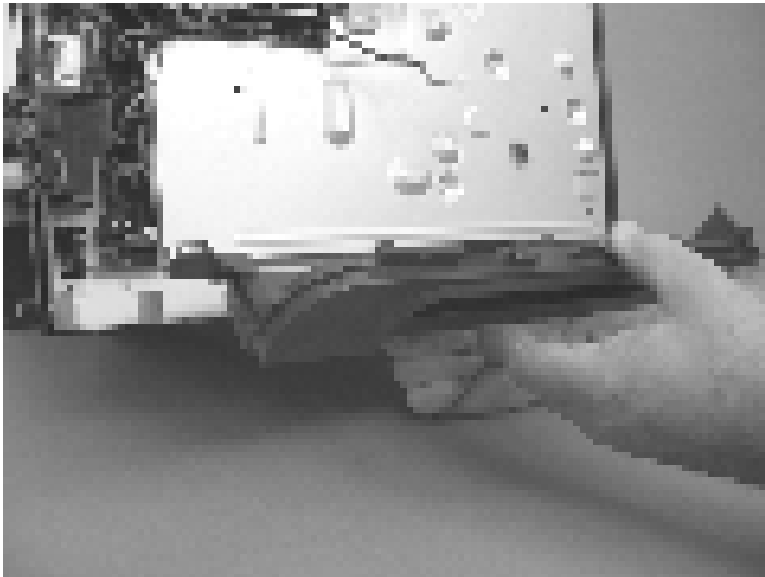
3. Raise the right side of the product (callout 1), slide the lower-right cover (callout 2) toward the front of the product, and then rotate the cover away from the product.

Figure 1-53 Remove the lower right cover (2 of 3)



4. Remove the lower-right cover.

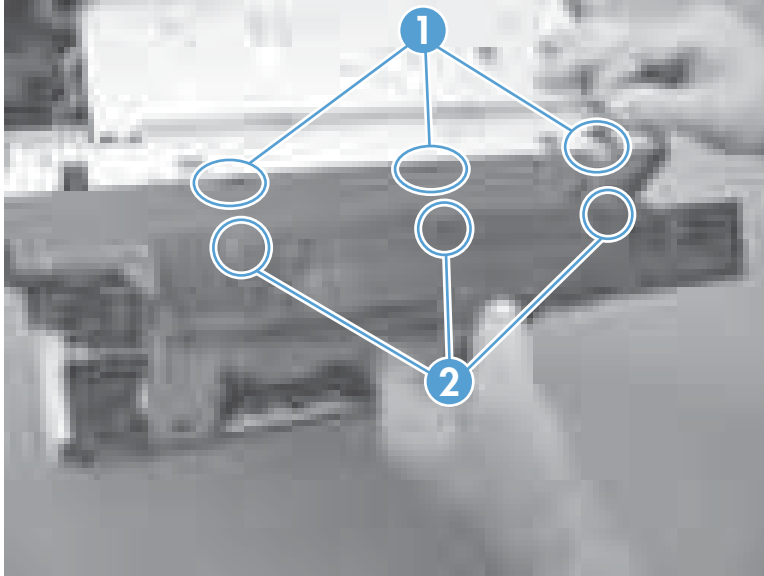
Figure 1-54 Remove the lower right cover (3 of 3)



Reinstall the lower right cover

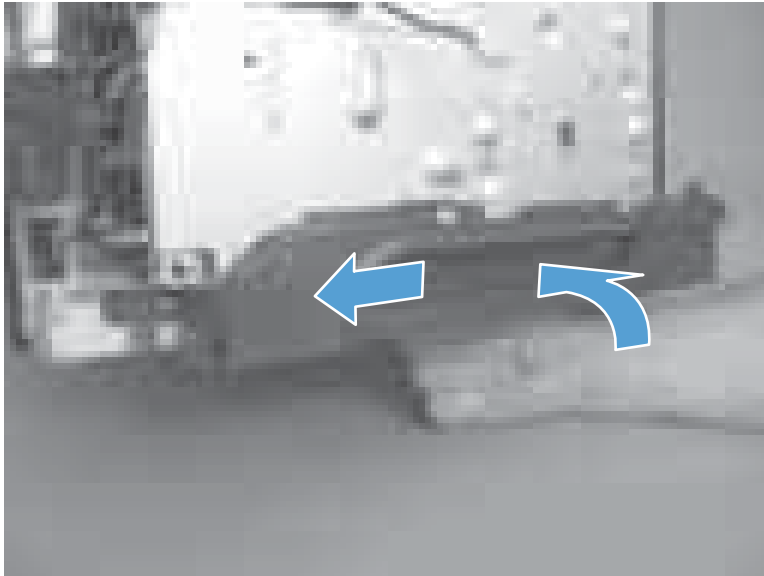
1. Carefully raise the right side of the product, find the three slots in the chassis (callout 1), and the three tabs (callout 2) along the bottom of the cover.

Figure 1-55 Reinstall the lower right cover (1 of 2)



2. Rotate the cover up to engage the tabs with the slots, and then slide the cover toward the front of the product to install it.

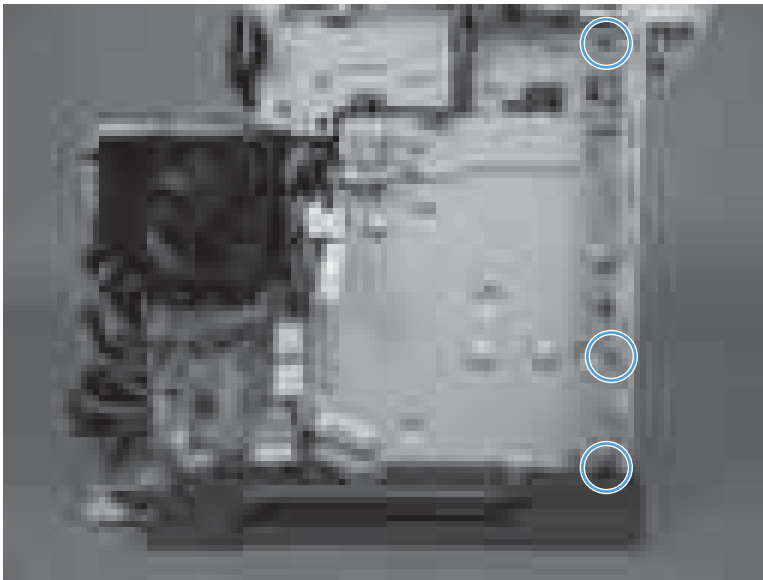
Figure 1-56 Reinstall the lower right cover (2 of 2)




I/O plate

1. Before proceeding, remove the following:
 - Formatter cover. See [Formatter cover on page 18](#).
 - Formatter PCA. See [Formatter PCA on page 19](#).
 - Fax PCA. See [Fax PCA and cable on page 20](#).
 - ICB, See [Interconnect board \(ICB\) on page 21](#).
 - Formatter stay. See [Formatter stay on page 22](#).
 - Rear cover assembly. See [Rear cover assembly on page 24](#).
 - Right-rear cover. See [Right-rear cover on page 30](#).
 - Right cover assembly. See [Right cover assembly on page 36](#).
2. Remove three screws.

Figure 1-57 Remove the I/O plate (1 of 2)



3. Slide the sheet-metal bracket up to release it, and then remove the bracket.

 **NOTE:** You might need to pull outward on the lower-right cover (callout 1) to release the sheet-metal bracket.


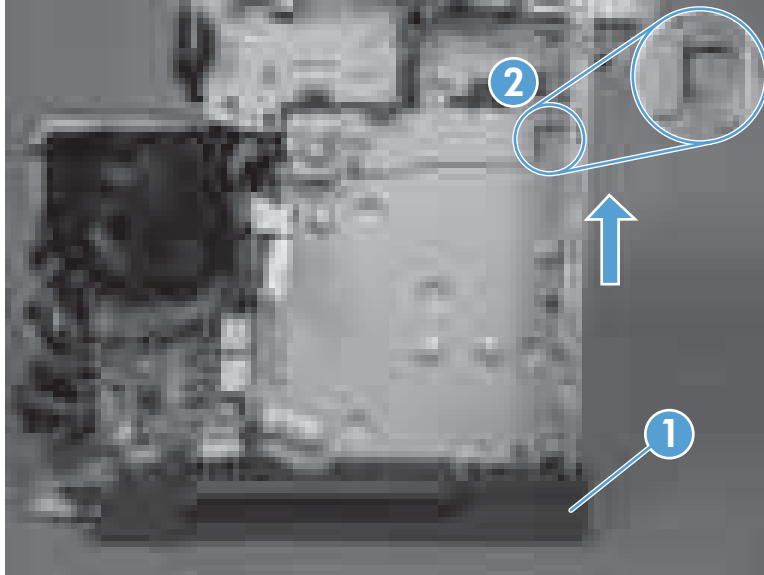
 **Reinstallation tip** When you reinstall the bracket, make sure that the tab is engaged in the slot in the chassis (callout 2).

Figure 1-58 Remove the I/O plate (2 of 2)

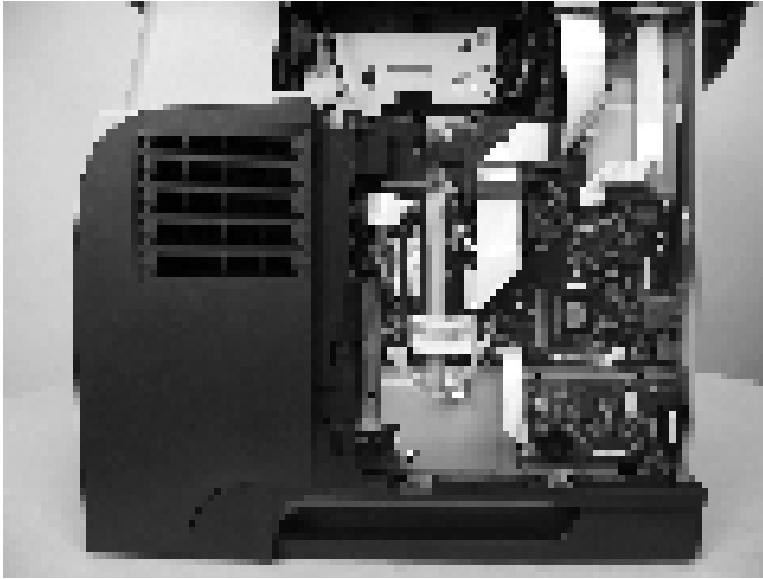


Document feeder assemblies and scanner

Document feeder/scanner assembly

1. Before proceeding, remove the following:
 - Formatter cover. See [Formatter cover on page 18](#).
 - Dummy cover. See [Dummy cover on page 23](#).
 - Rear cover assembly. See [Rear cover assembly on page 24](#).
 - Left cover. See [Left cover on page 28](#).
2. Disconnect four FFCs, the FFC holder (held in place by one screw and one tab), and three connectors (M521dw) or two connectors (M521dn) from the formatter PCA.

Figure 1-59 Remove the document feeder/scanner assembly (1 of 7)



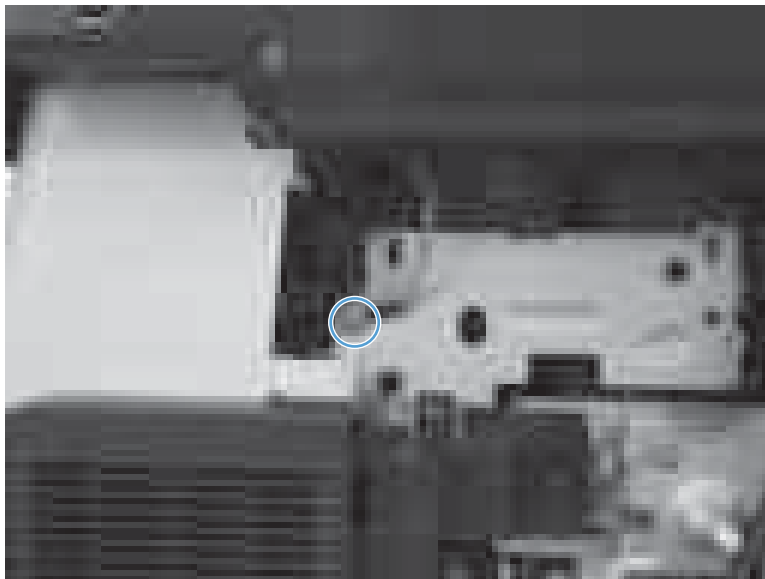
3. Feed the FFCs and connectors through their retainers.

Figure 1-60 Remove the document feeder/scanner assembly (2 of 7)



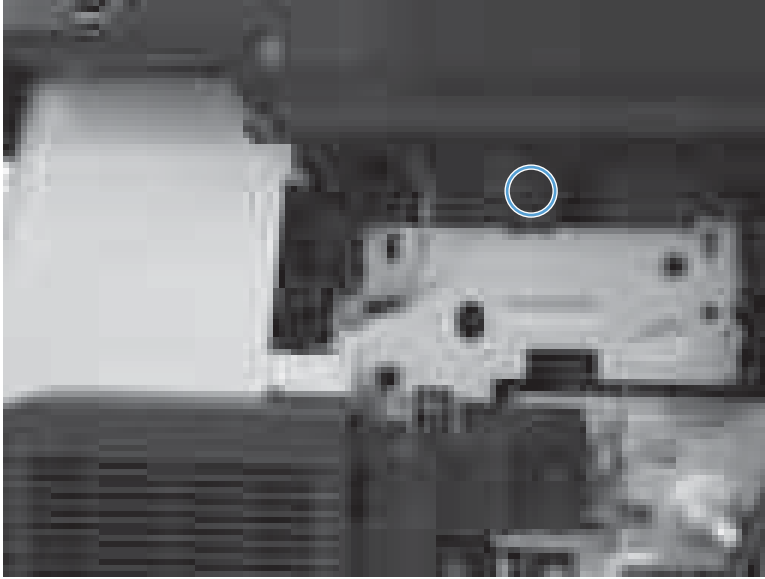
4. Disconnect one screw, and then remove the USB ground wire.

Figure 1-61 Remove the document feeder/scanner assembly (3 of 7)



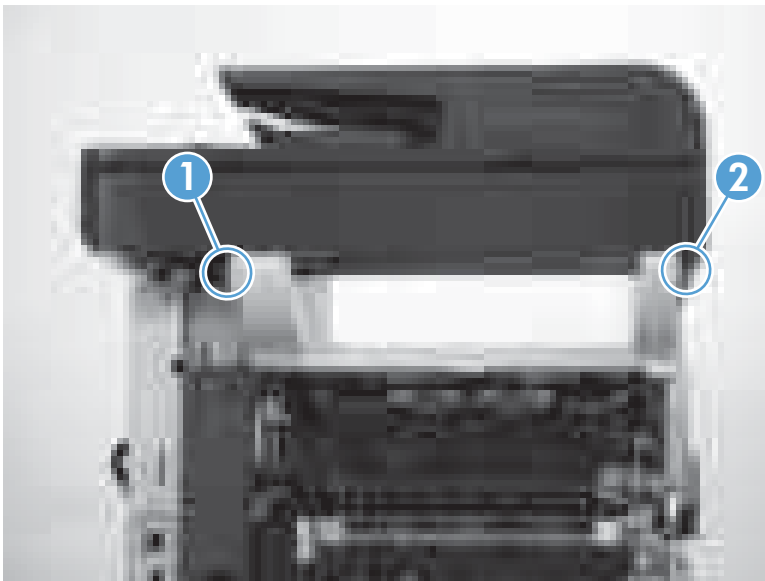
5. Remove one screw on the right side of the document feeder/scanner assembly.

Figure 1-62 Remove the document feeder/scanner assembly (4 of 7)



6. Remove one screw on the rear-right side of the document feeder/scanner assembly (callout 1), and then remove the grounding screw on the rear-left side of the document feeder/scanner assembly (callout 2).

Figure 1-63 Remove the document feeder/scanner assembly (5 of 7)



7. Remove one screw on the left-side of the document feeder/scanner assembly.


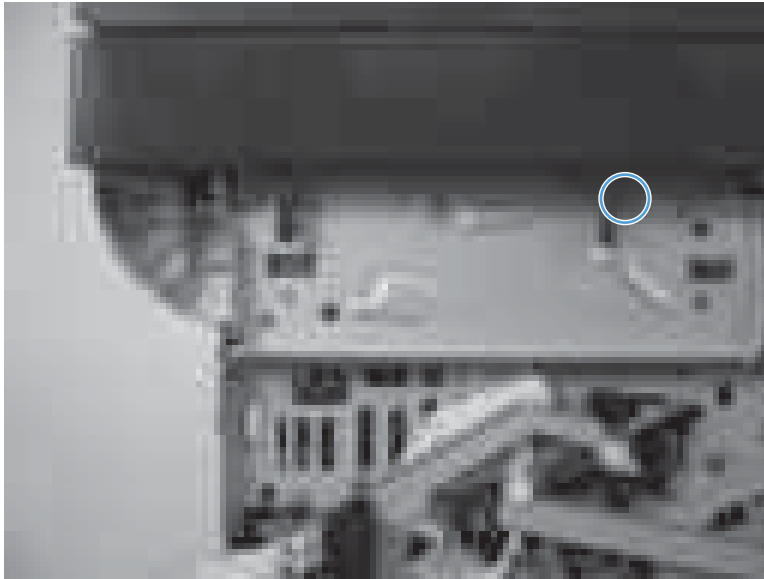
 **NOTE:** Rear-right document feeder/scanner ground screw shown still installed in this photo.

Figure 1-64 Remove the document feeder/scanner assembly (6 of 7)



8. Slide the document feeder/scanner assembly back, and then pull up to remove.

Figure 1-65 Remove the document feeder/scanner assembly (7 of 7)



Document feeder/scanner whole unit reinstallation

1. When reinstalling the document feeder/scanner assembly, align the four alignment pins on the bottom of the document feeder/scanner assembly with the slots on the chassis.

Figure 1-66 Reinstall the document feeder/scanner assembly (1 of 3)



2. Ensure the FFCs and cables are routed through the retainers on the right side of the product.

Figure 1-67 Reinstall the document feeder/scanner assembly (2 of 3)



3. When reinstalling the document feeder ground wire, tuck the grounding wire to the left side so it does not interfere with reinstallation of the left cover assembly.

Figure 1-68 Reinstall the document feeder/scanner assembly (3 of 3)

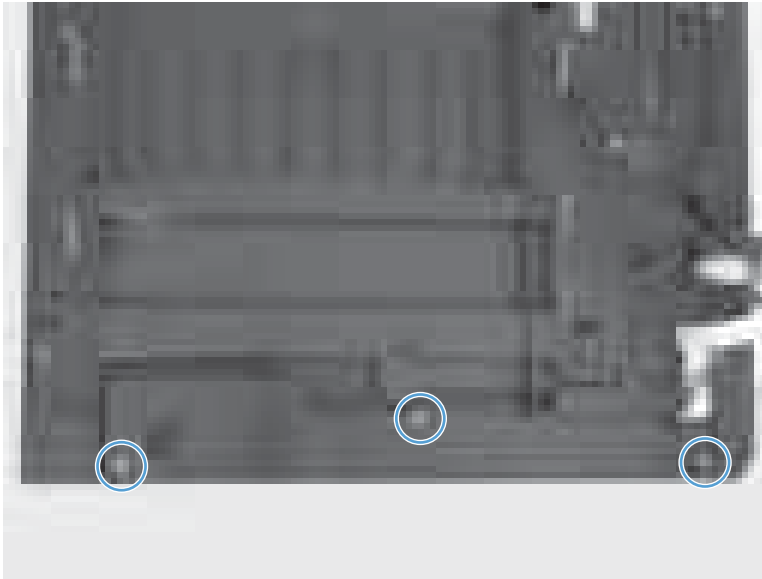


Document feeder whole unit kit and scanner whole unit kit

Use the following procedure to separate the document feeder assembly from the scanner assembly when either whole unit kit is being replaced.

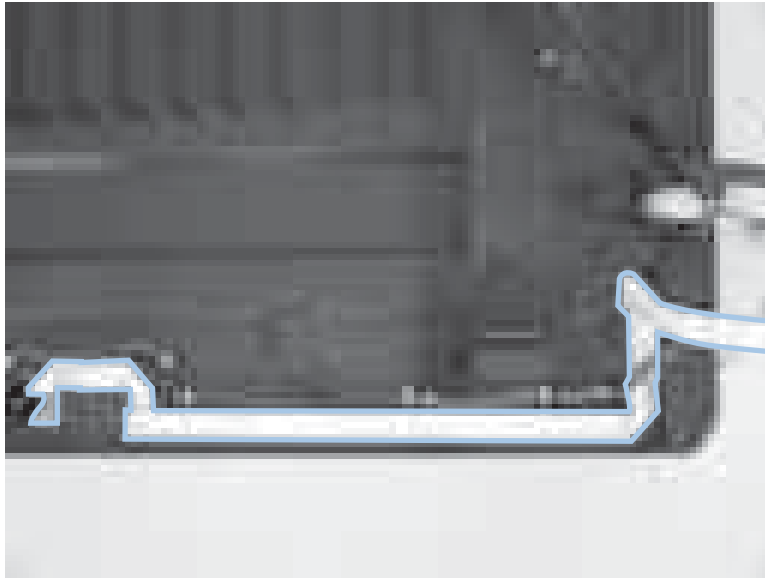
1. Before proceeding, remove the following:
 - Document feeder/scanner assembly. See [Document feeder/scanner assembly on page 46](#)
2. Carefully place the document feeder/scanner assembly upside down on a flat surface.
3. Remove three screws and remove the scanner rear cover.

Figure 1-69 Remove the Document feeder whole unit kit and scanner whole unit kit (1 of 6)



4. Carefully separate the adhesive-backed FFC from the document feeder/scanner assembly and remove it from the channel beneath the scanner rear cover.

Figure 1-70 Remove the Document feeder whole unit kit and scanner whole unit kit (2 of 6)



5. Cut the plastic cable ties holding the wire harness to the document feeder/scanner assembly and remove it from the channel beneath scanner rear cover.


 **NOTE:** Replace the cable ties to secure the wire harness when reinstalling the document feeder/scanner whole unit.

Figure 1-71 Remove the Document feeder whole unit kit and scanner whole unit kit (3 of 6)

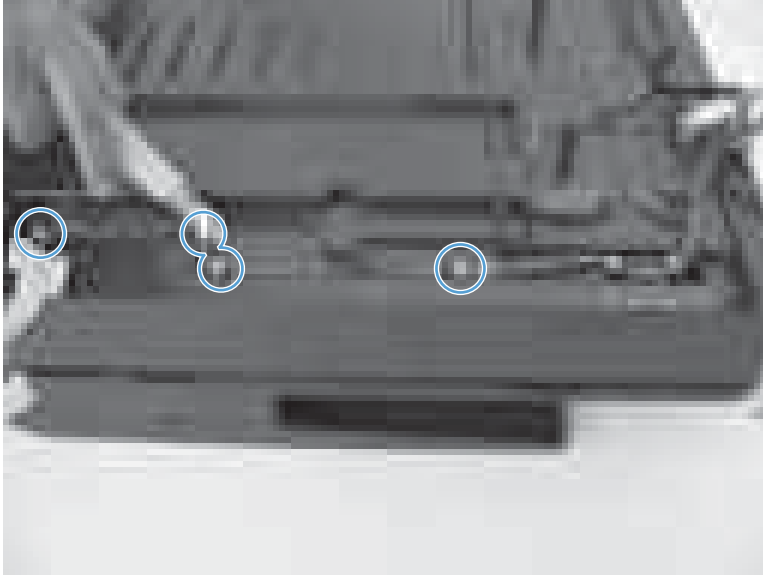
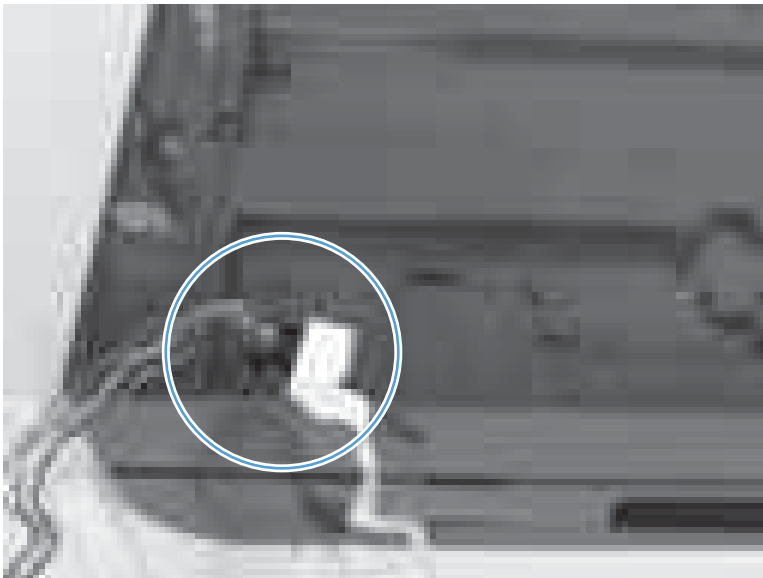
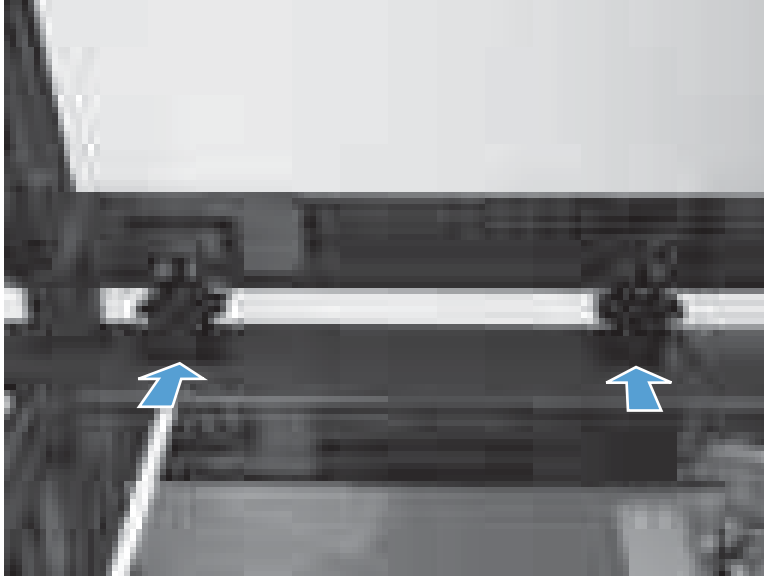


Figure 1-72 Remove the Document feeder whole unit kit and scanner whole unit kit (4 of 6)



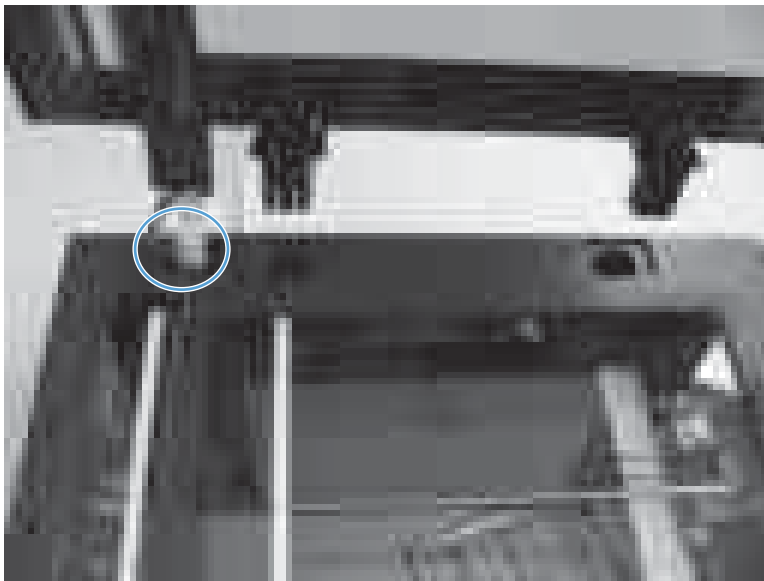
6. Place the document feeder/scanner assembly right-side up on a flat surface. Lift the document feeder assembly up and release two tabs.

Figure 1-73 Remove the Document feeder whole unit kit and scanner whole unit kit (5 of 6)



7. Lift the document feeder assembly up and carefully feed the FFC and wire harness through the slot in the scanner assembly to separate the document feeder assembly from the scanner assembly.

Figure 1-74 Remove the Document feeder whole unit kit and scanner whole unit kit (6 of 6)

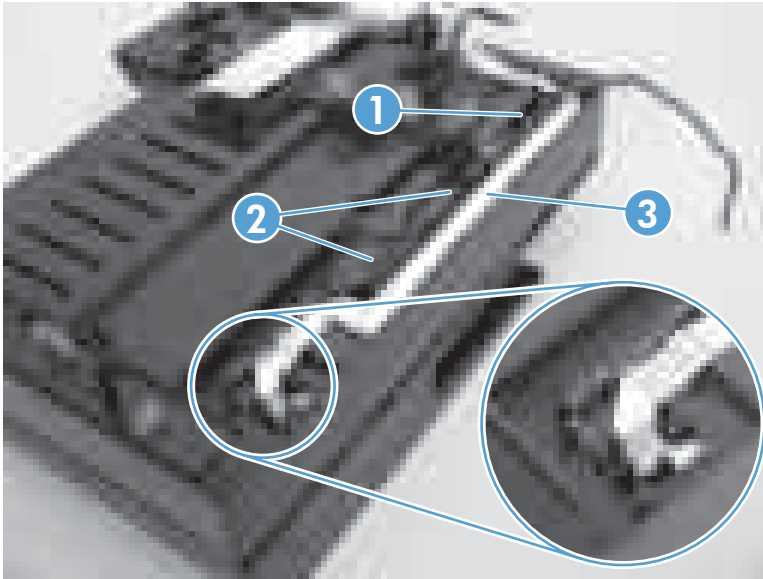


Document feeder assembly and scanner assembly reinstallation tips

1. Install new cable ties for the wire harness.
2. Fit the ferrite core into its slot (callout 1), route the wire harness (callout 2), and then tie off the wire harness with the cable ties.

3. Route the FFC (callout 3) and reattach it.

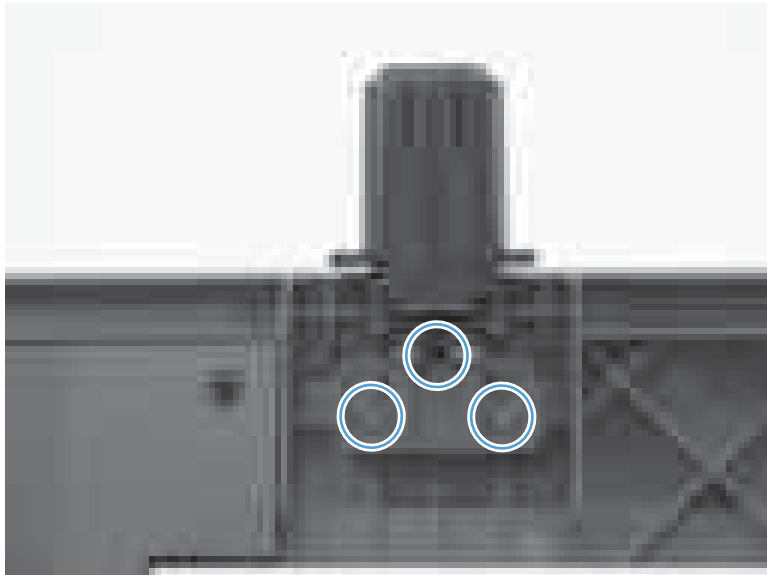
Figure 1-75 Document feeder assembly and scanner assembly reinstallation tips



Document feeder hinge assembly

1. Open the document feeder cover.
2. Remove three screws and the document feeder hinge assembly.

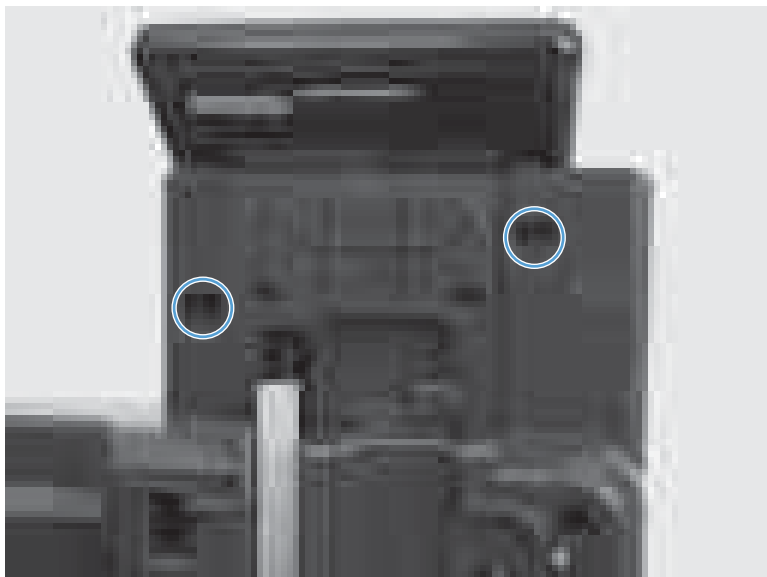
Figure 1-76 Remove the document feeder hinge assembly



Control-panel top-cover

1. Release two tabs on the under-side of the control-panel assembly.

Figure 1-77 Remove the control-panel top-cover (1 of 2)



2. Lift the top-cover up to remove.

Figure 1-78 Remove the control-panel top-cover (2 of 2)

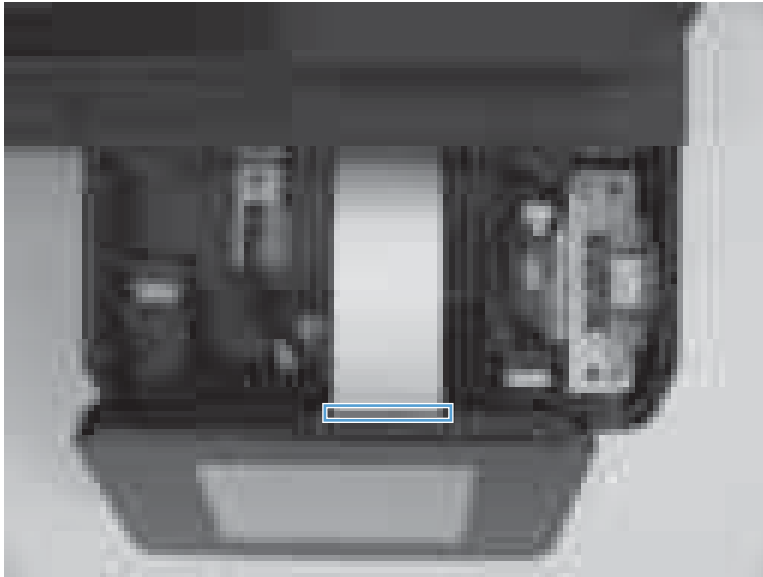


Control-panel assembly

⚠ WARNING!  ESD sensitive component.

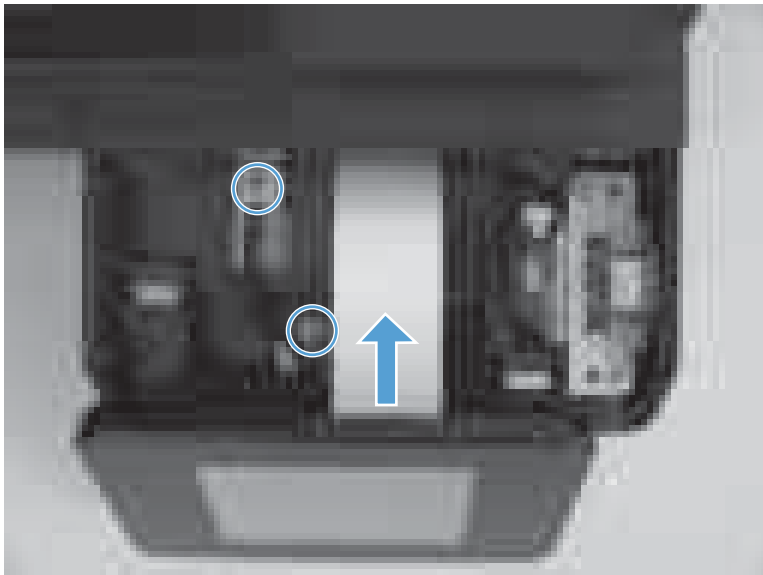
1. Before proceeding, remove the following:
 - Control-panel top-cover. See [Control-panel top-cover on page 57](#).
2. Press forward on the control-panel sub-cover and remove the sub-cover.

Figure 1-79 Remove the control-panel (1 of 3)




3. Remove the ground screw and wire, the screw holding the control-panel to the tray, and one FFC.

Figure 1-80 Remove the control-panel (2 of 3)



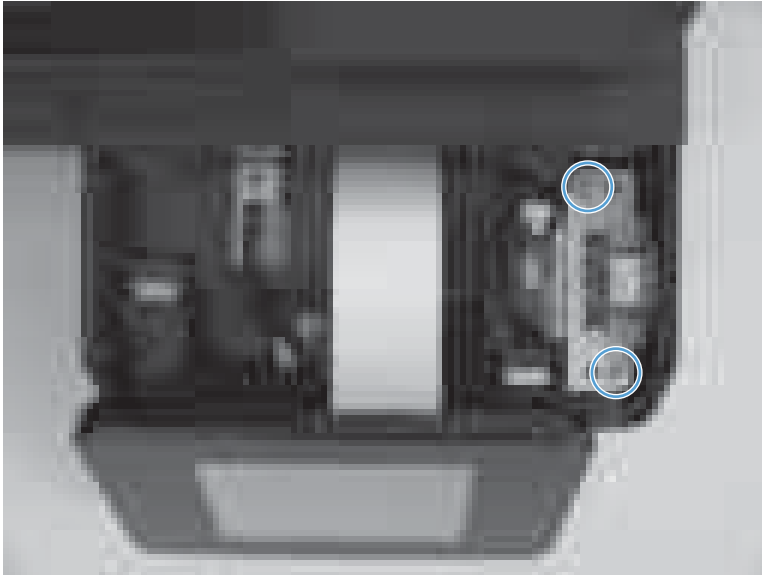
4. Slide the control-panel assembly forward and remove.

USB PCA

 **NOTE:** It is not necessary to remove the control-panel assembly to remove the USB PCA. However, it might be easier to remove the USB PCA with the control-panel assembly removed.

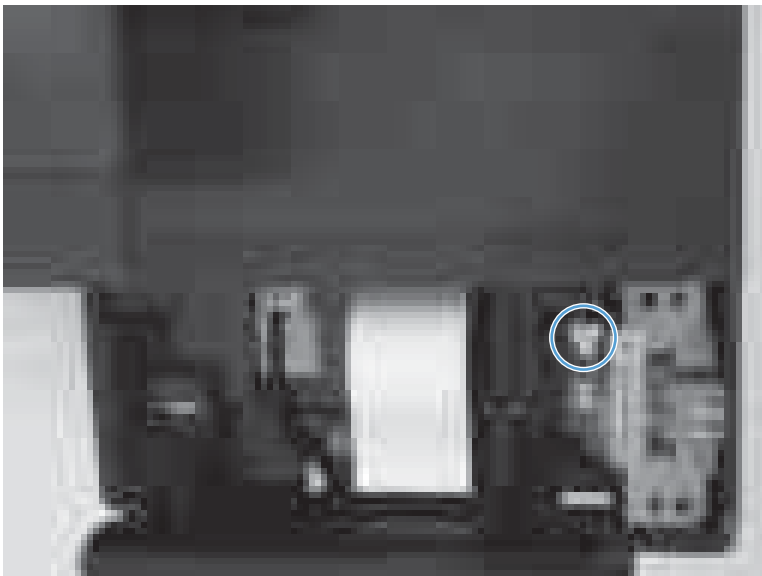
1. Disconnect the ground wire screw and remove the ground wire. Disconnect one screw near the front of the USB PCA subassembly.


Figure 1-81 Remove the USB PCA (1 of 4)



2. Disconnect the USB cable.

Figure 1-82 Remove the USB PCA (2 of 4)



 **TIP:** When reinstalling the USB PCA assembly, connect the USB cable *before* installing the grounding screw and the screw near the front of the USB PCA assembly.

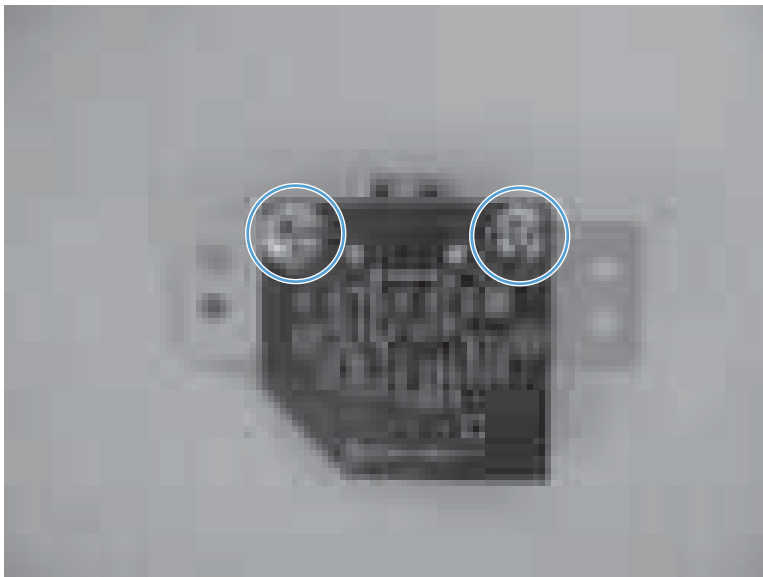
3. Remove the USB PCA subassembly from the chassis.

Figure 1-83 Remove the USB PCA (3 of 4)



4. Place the USB PCA subassembly on a level surface. Remove two screws, and then remove the USB PCA from the sheet metal bracket.

Figure 1-84 Remove the USB PCA (4 of 4)

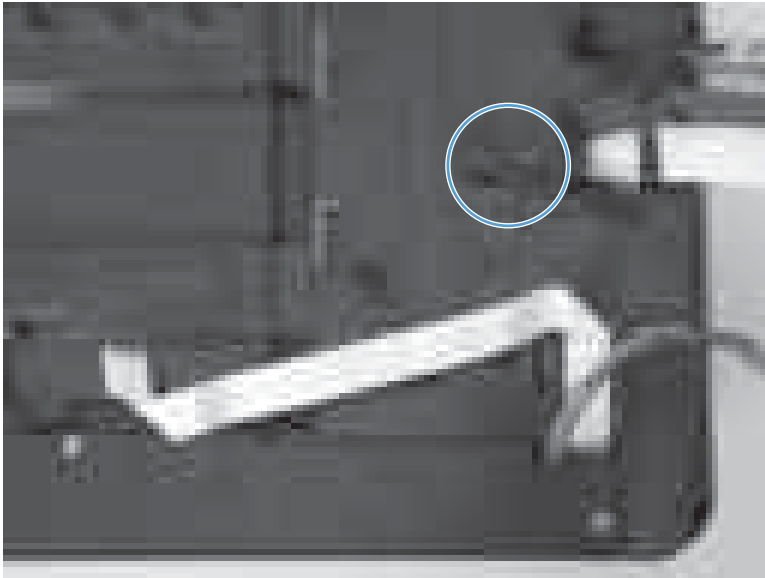


Control-panel FFC

1. Before proceeding, remove the following:
 - Document feeder/scanner assembly. See [Document feeder assemblies and scanner on page 46](#).
 - Control-panel top cover. See [Control-panel top-cover on page 57](#).

2. Carefully place the document feeder/scanner assembly upside down on a level surface. Carefully separate the black, adhesive-attached scanner and motor FFCs and Wi-Fi module cables from the scanner lower cover.

Figure 1-85 Remove the control-panel FFC (1 of 6)



3. Remove three screws from the scanner lower cover.

Figure 1-86 Remove the control-panel FFC (2 of 6)



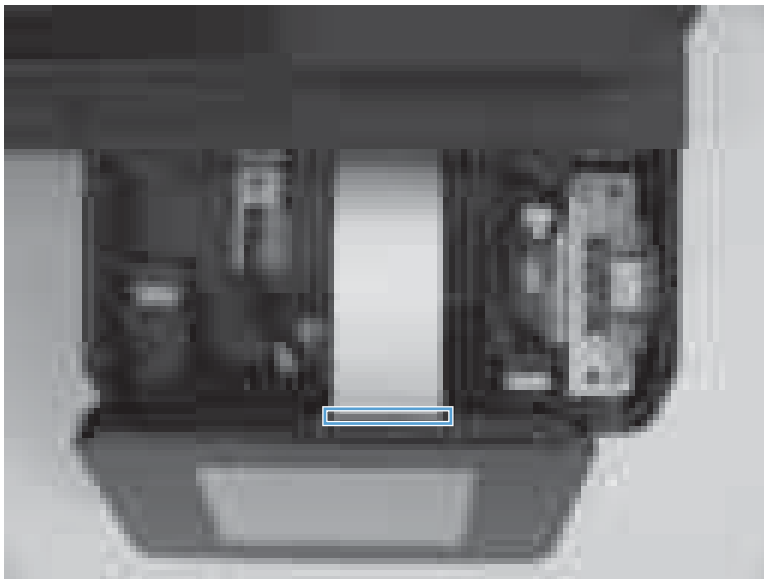
4. Release one tab and remove the scanner lower cover. Feed the USB and Wi-Fi module cables, and the control-panel FFC, through the openings in the lower cover as you are removing the lower cover.

Figure 1-87 Remove the control-panel FFC (3 of 6)



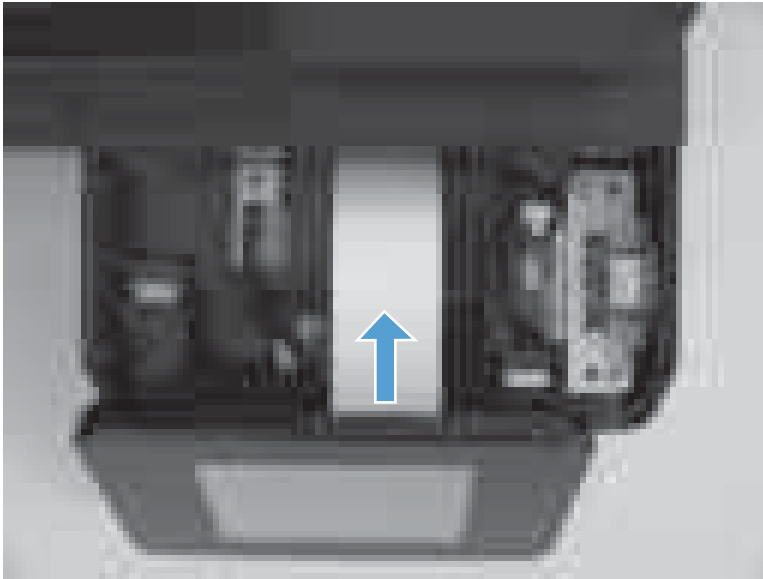
5. Press forward on the control-panel sub-cover, and then remove the sub-cover.

Figure 1-88 Remove the control-panel FFC (4 of 6)



6. Disconnect the control-panel FFC from the control-panel assembly.

Figure 1-89 Remove the control-panel FFC (5 of 6)



7. Remove the control-panel FFC from the document feeder/scanner assembly.

Figure 1-90 Remove the control-panel FFC (6 of 6)

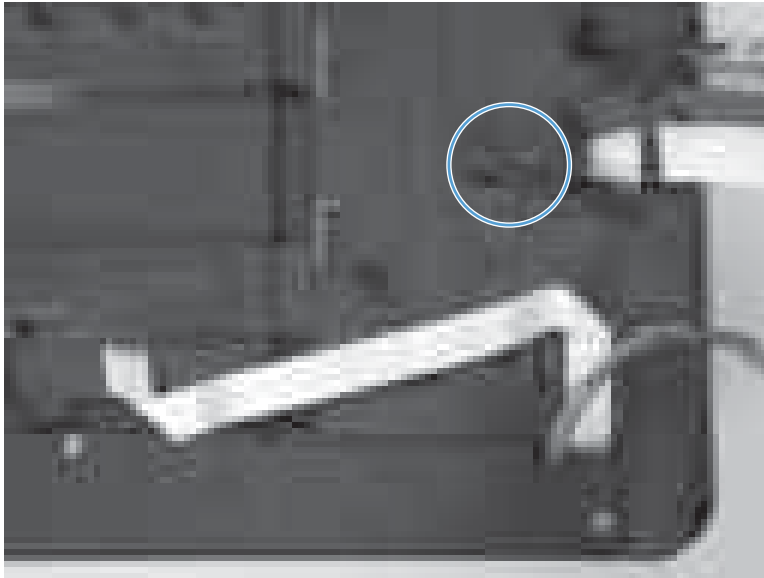


USB cable and USB grounding cable

1. Before proceeding, remove the following:
 - Document feeder/scanner assembly. See [Document feeder assemblies and scanner on page 46](#).

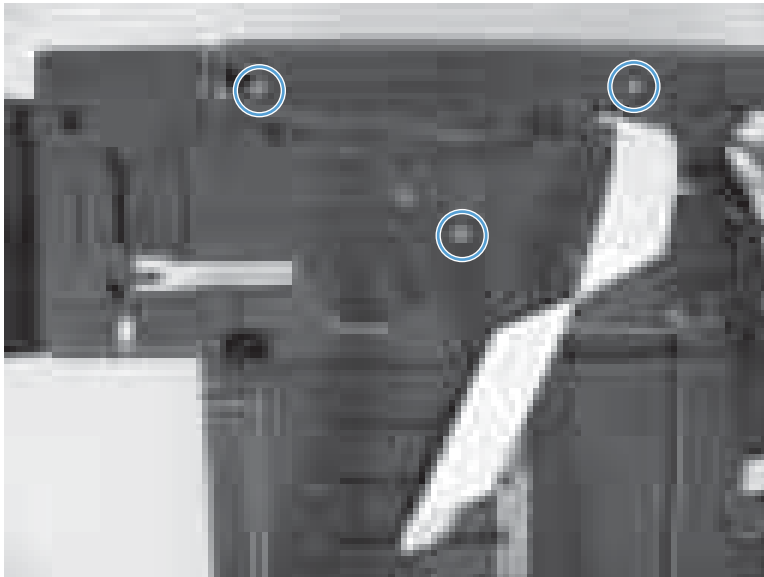
2. Carefully place the document feeder/scanner assembly upside down on a level surface. Carefully separate the black, adhesive-attached scanner and motor FFCs from the scanner lower cover.

Figure 1-91 Remove the USB cable and USB grounding cable (1 of 5)



3. Remove three screws from the scanner lower cover.

Figure 1-92 Remove the USB cable and USB grounding cable (2 of 5)



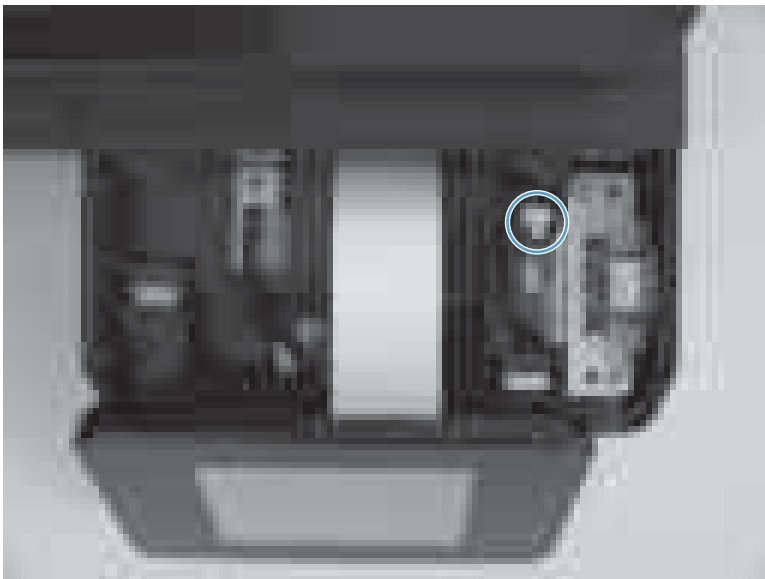
4. Release one tab and remove the scanner lower cover. Feed the USB and Wi-Fi module FFCs and the control-panel FFC through the openings in the lower cover as you are removing the lower cover.

Figure 1-93 Remove the USB cable and USB grounding cable (3 of 5)



5. Disconnect the USB cable connector from the USB PCA.

Figure 1-94 Remove the USB cable and USB grounding cable (4 of 5)



6. Feed the USB cable and the USB grounding cable through the slot in cover to remove.

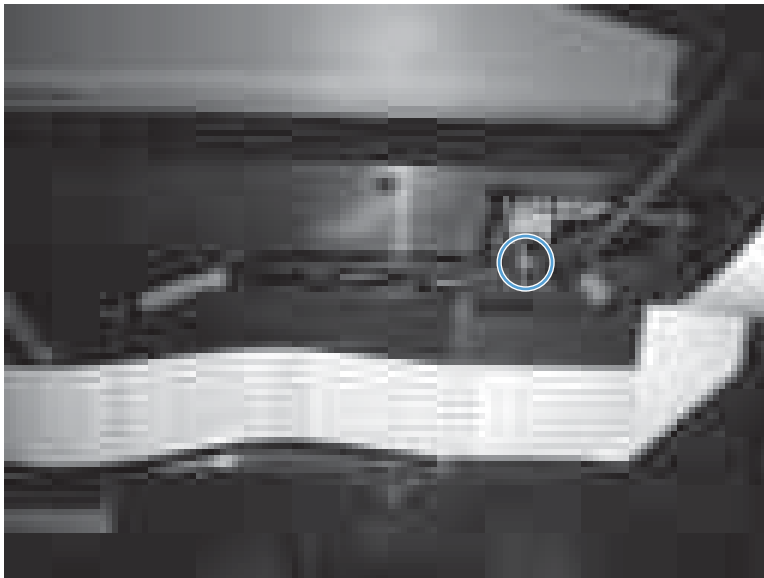
Figure 1-95 Remove the USB cable and USB grounding cable (5 of 5)



USB cable re-installation

- ▲ When reinstalling the USB cable, align the white mark on the cable with the slot near the Wi-Fi module.

Figure 1-96 Reinstall USB cable

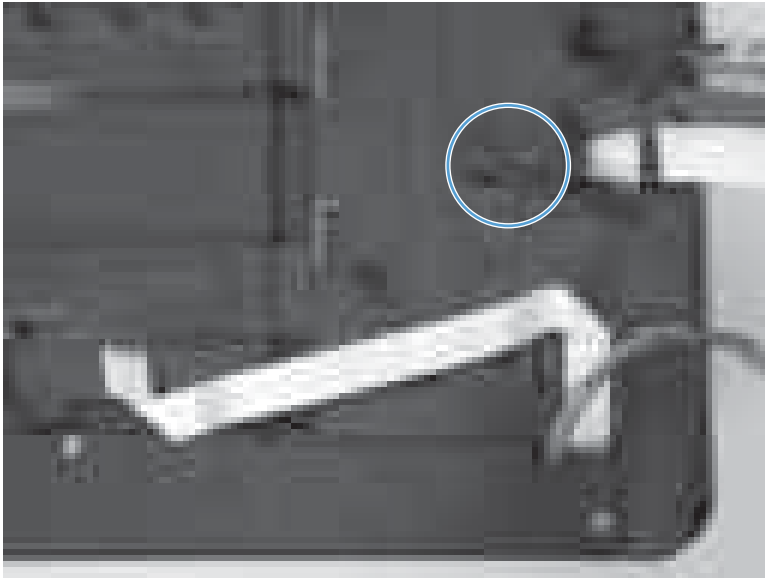


Wi-Fi module and cable

1. Before proceeding, remove the following:
 - Document feeder/scanner assembly. See [Document feeder assemblies and scanner on page 46](#).

2. Carefully place the document feeder/scanner assembly upside down on a level surface. Carefully separate the black, adhesive-attached scanner and motor FFCs and Wi-Fi module FFCs from the scanner lower cover.

Figure 1-97 Remove the Wi-Fi module and cable (1 of 6)



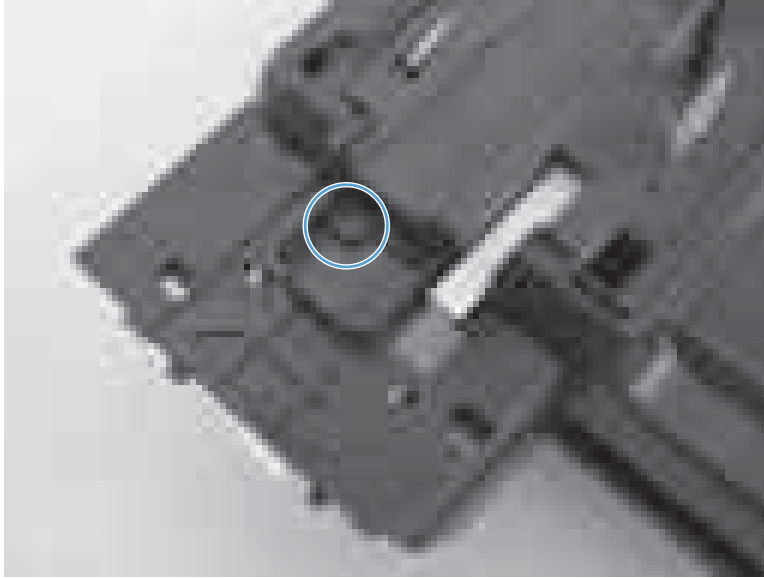
3. Remove three screws from the scanner lower cover.

Figure 1-98 Remove the USB cable and USB grounding cable (2 of 6)



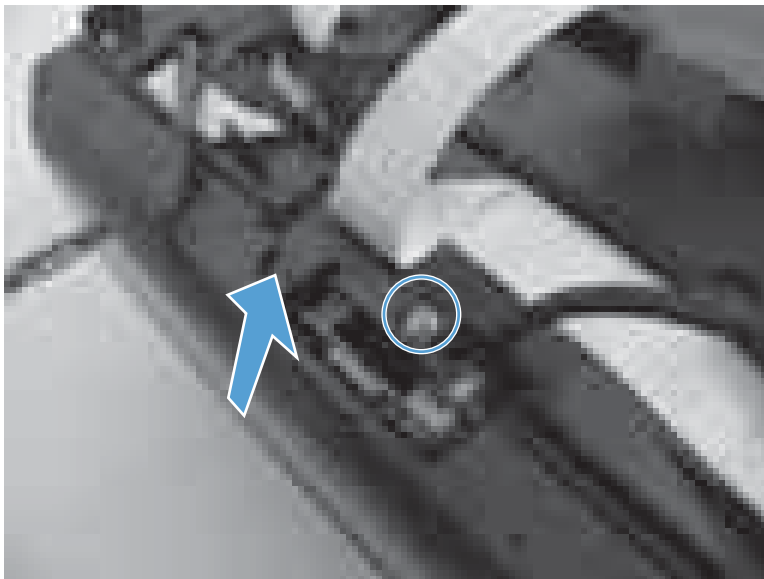
4. Release one tab and remove the scanner lower cover. Feed the USB and Wi-Fi module cables and the control-panel FFC through the openings in the lower cover as you are removing the lower cover.

Figure 1-99 Remove the Wi-Fi module and cable (3 of 6)



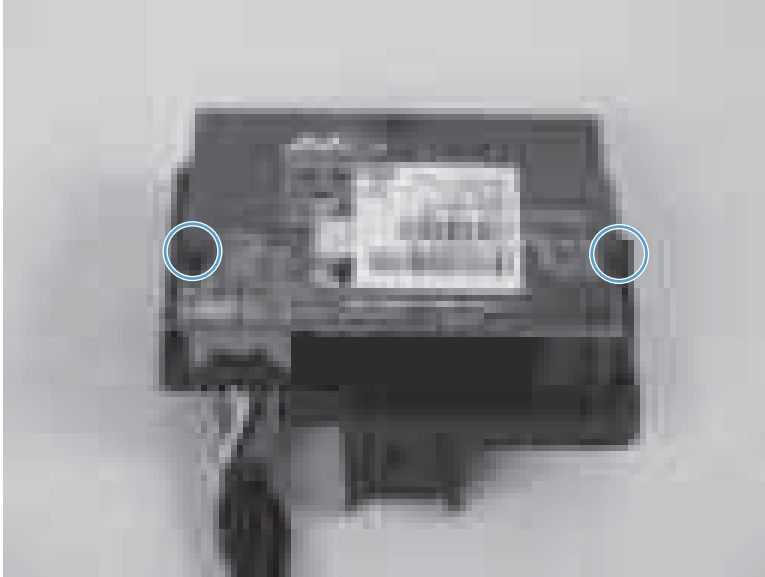
5. Remove one screw, and then remove the Wi-Fi module mounting bracket.

Figure 1-100 Remove the Wi-Fi module and cable (4 of 6)



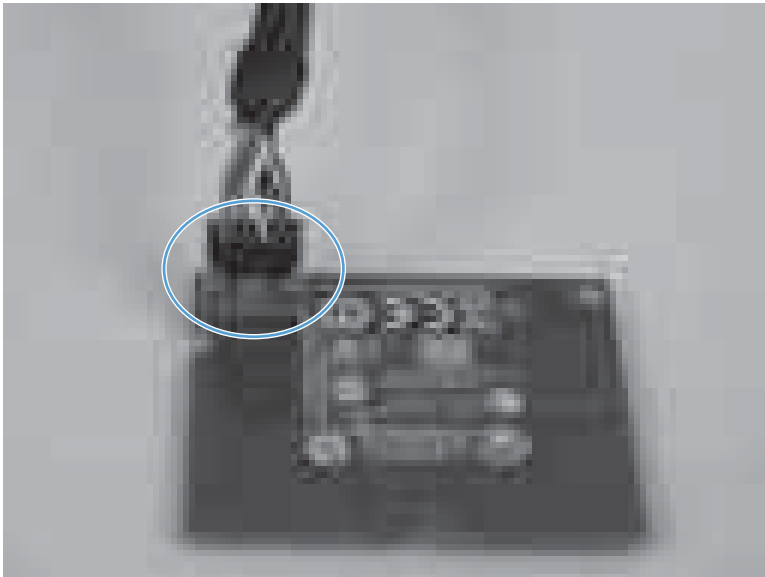
6. Release two tabs, and then remove the Wi-Fi module from the mounting bracket.

Figure 1-101 Remove the Wi-Fi module and cable (5 of 6)



7. Disconnect the Wi-Fi cable from the Wi-Fi module.

Figure 1-102 Remove the Wi-Fi module and cable (6 of 6)



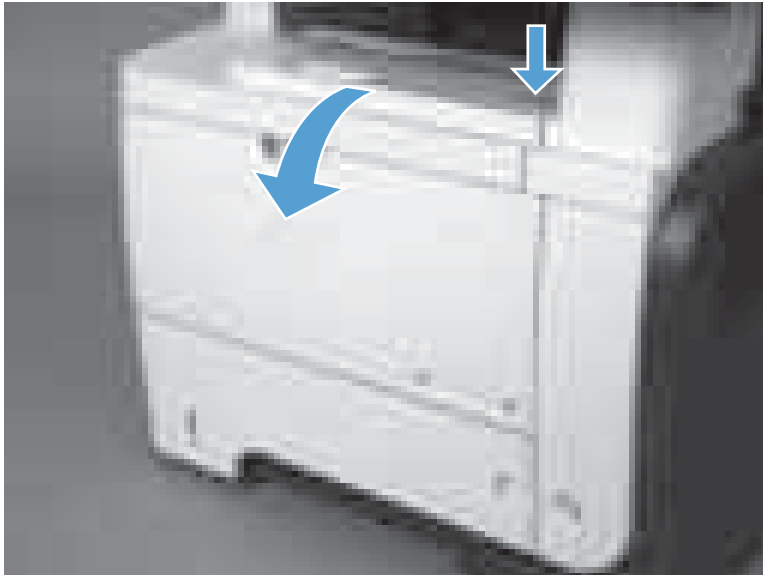
Main assemblies

Tray 1 pickup roller

⚠ CAUTION: Do not touch the surface of the roller. Skin oils deposited on the roller might cause print-quality problems.

1. Press the cartridge-door release button, and then open the cartridge door. Make sure that the door is completely open.

Figure 1-103 Remove the Tray 1 pickup roller (1 of 2)



2. Release two tabs, and then rotate the roller out and away from the product to remove it.


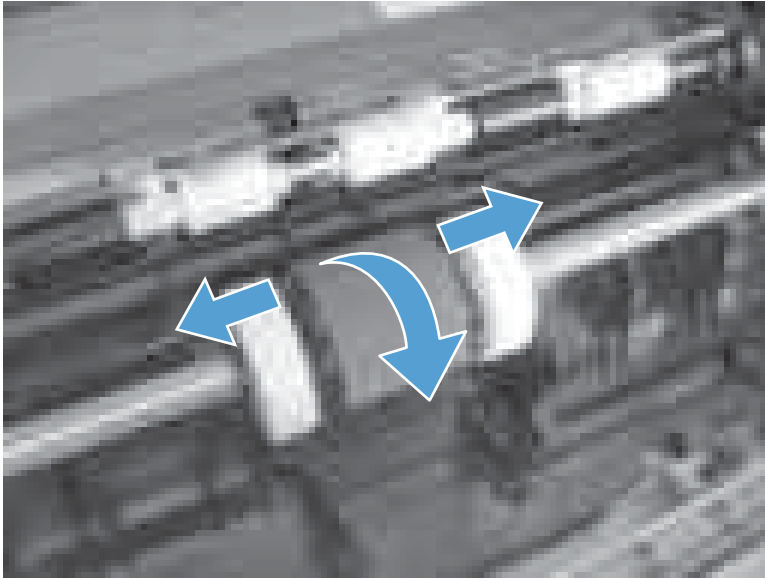
 **TIP:** It might be easier to release the tabs by using a small flat-tip screwdriver.

Figure 1-104 Remove the Tray 1 pickup roller (2 of 2)

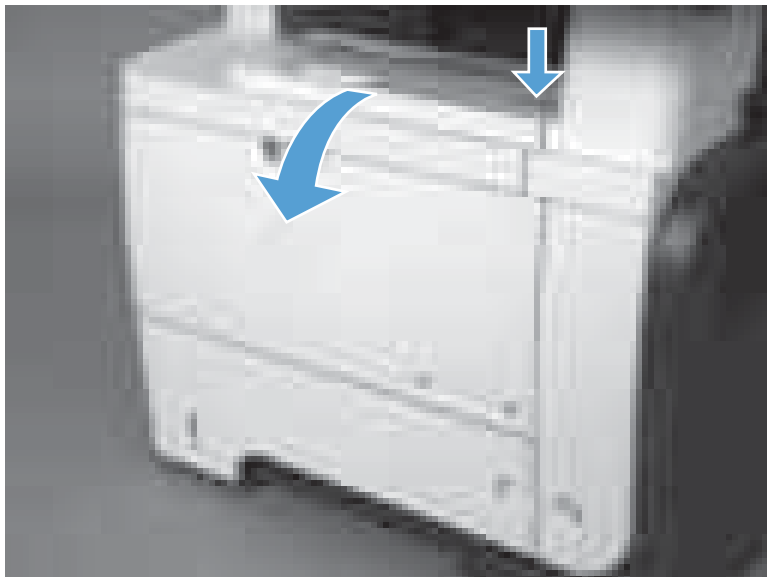


Tray 1 separation pad

⚠ CAUTION: Do not touch the surface of the pad. Skin oils deposited on the roller might cause paper-handling problems.

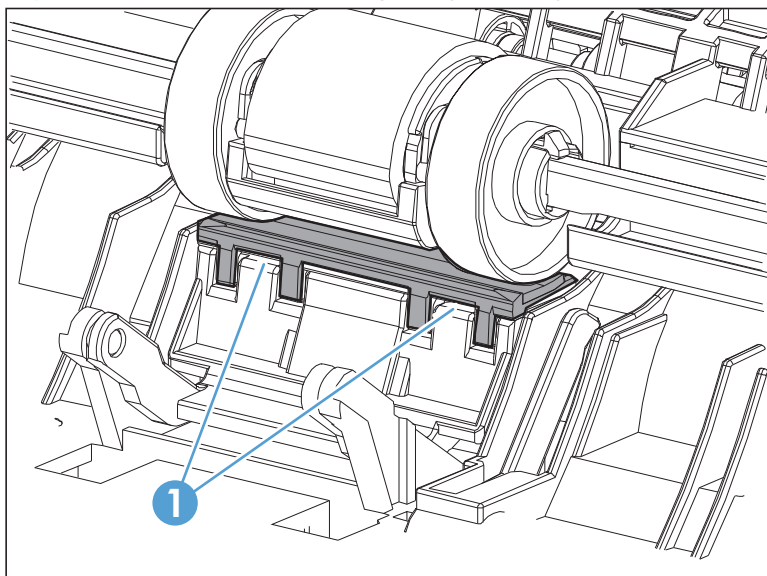
1. Press the cartridge-door release button, and then open the cartridge door. Make sure that the door is completely open.

Figure 1-105 Remove the Tray 1 separation pad (1 of 2)



2. Release two tabs (callout 1), and then remove the separation pad.

Figure 1-106 Remove the Tray 1 separation pad (2 of 2)



Tray 2 or Tray 3 pickup roller

CAUTION: Do not touch the surface of the roller. Skin oils deposited on the roller might cause print-quality problems.

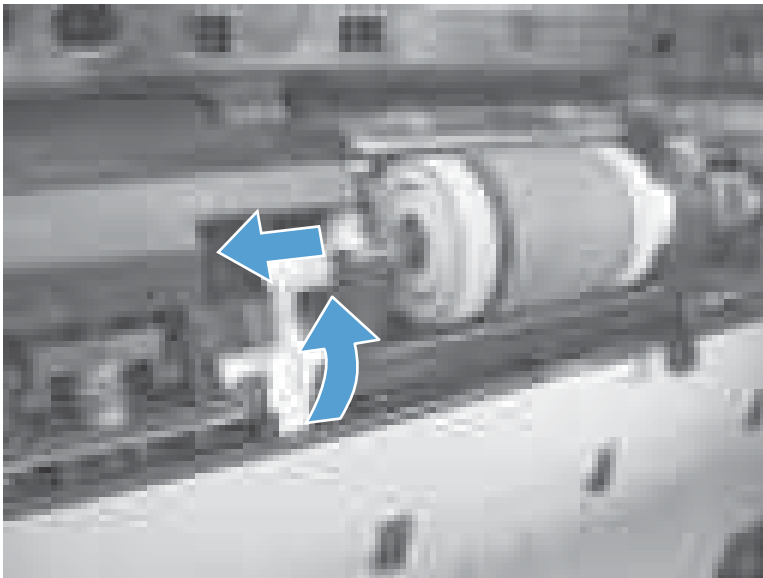
NOTE: If you did not remove Tray 2 or Tray 3 before servicing the product, remove them now.

1. Carefully place the product front-side up, so that you can see into the opening where the tray would be installed.

NOTE: Debris can scratch or damage the back of the product. Before you place the product front-side up, remove any debris from the work surface. If possible, set the product on a clean, dry cloth to prevent scratching and damage.

2. Release the roller bushing, rotate the bushing up, and then slide the bushing off of the roller shaft.

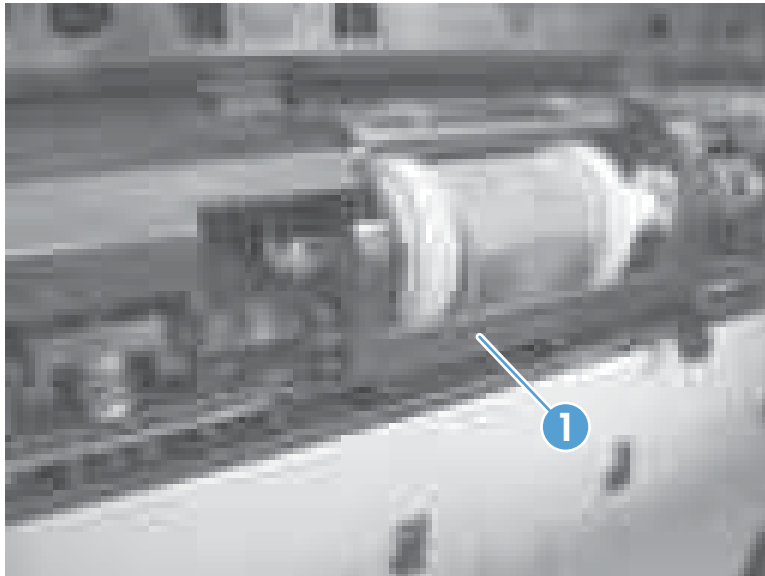
Figure 1-107 Remove the Tray 2 or Tray 3 pickup roller (1 of 3)



- Carefully remove the black-plastic guard (callout 1).

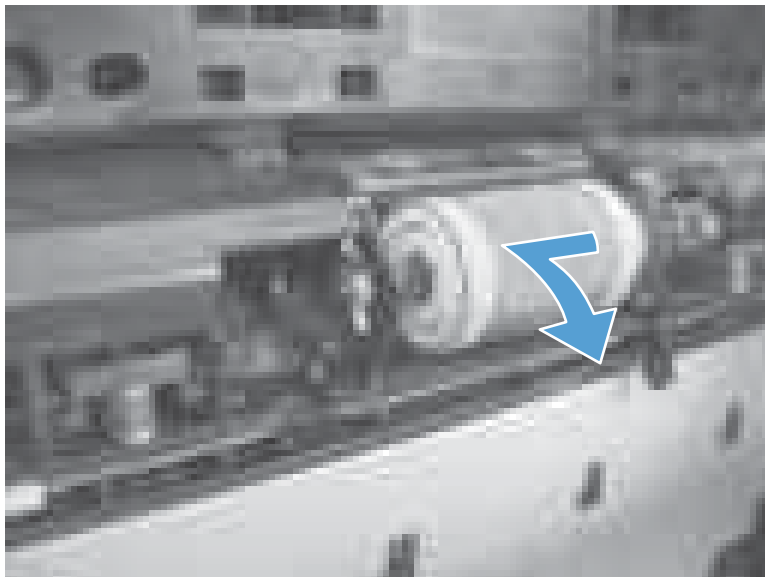
⚠ CAUTION: The guard is partially retained by the bushing removed in the previous step. Do not lose the guard when the bushing is removed.

Figure 1-108 Remove the Tray 2 or Tray 3 pickup roller (2 of 3)



- Slide the roller toward the left side of the product, rotate the right end of the roller away from the product, and then remove the roller assembly.

Figure 1-109 Remove the Tray 2 or Tray 3 pickup roller (3 of 3)

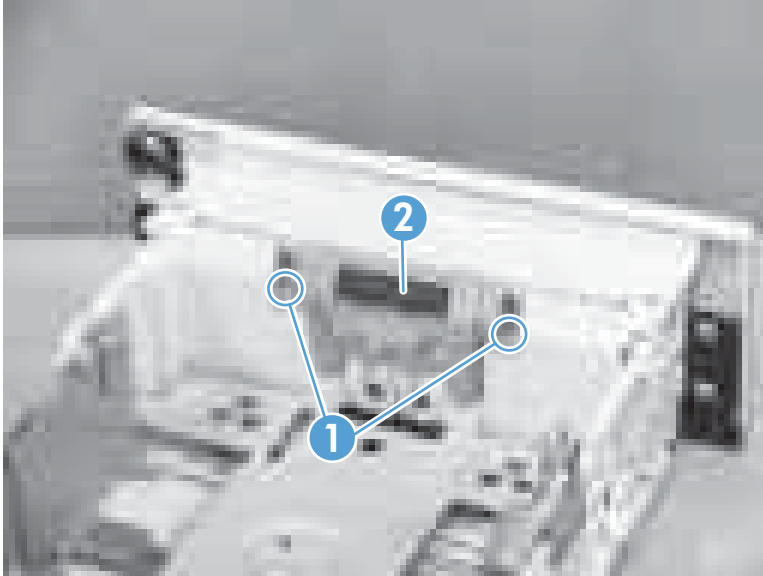


Tray 2 or Tray 3 separation pad

⚠ CAUTION: Do not touch the surface of the pad. Skin oils deposited on the roller might cause paper-handling problems.

1. Remove the tray. See [Tray 2 or Tray 3 assembly on page 13](#).
2. Remove two screws (callout 1), and then remove the separation pad (callout 2).

Figure 1-110 Remove the Tray 2 or Tray 3 separation pad

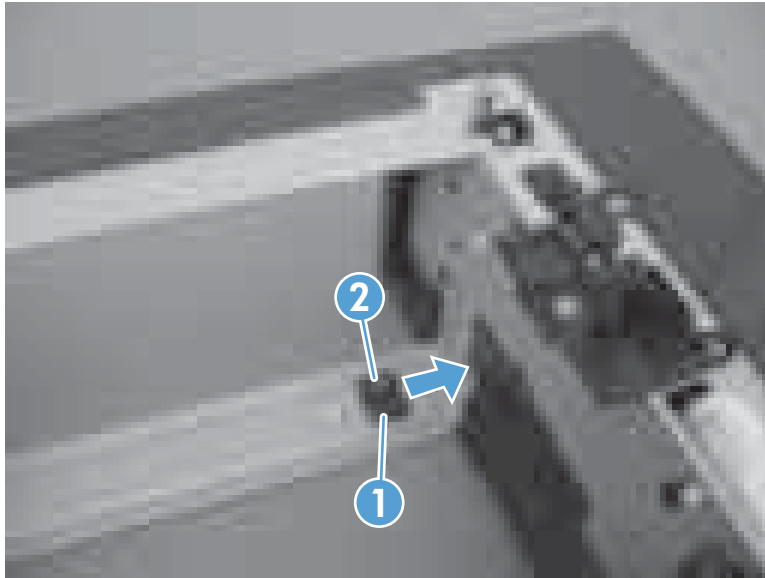


Tray 2 or Tray 3 base-plate roller assembly

1. Remove the tray. See [Tray 2 or Tray 3 assembly on page 13](#).

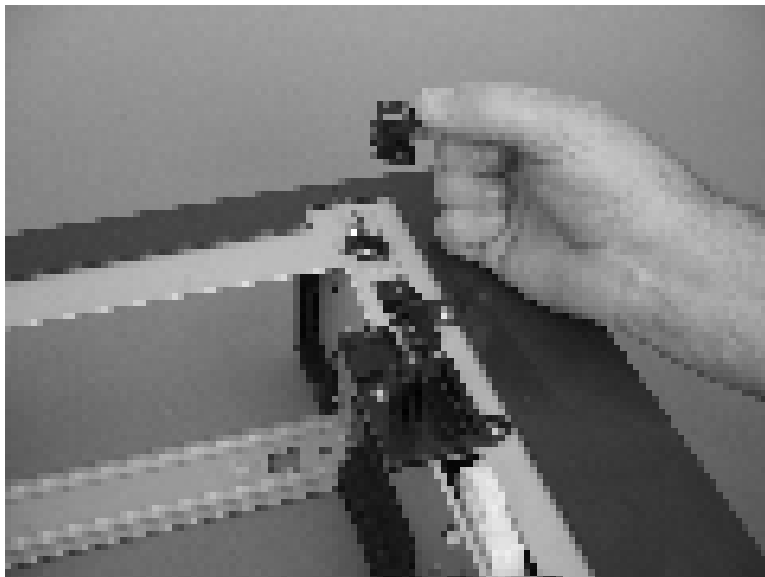
2. Locate the base roller assembly (callout 1), release one tab (callout 2), and then slide the assembly toward the outside of the product to release it.

Figure 1-111 Tray 2 or Tray 3 base-plate roller assembly (1 of 2)



3. Remove the base-plate roller assembly.

Figure 1-112 Tray 2 or Tray 3 base-plate roller assembly (2 of 2)



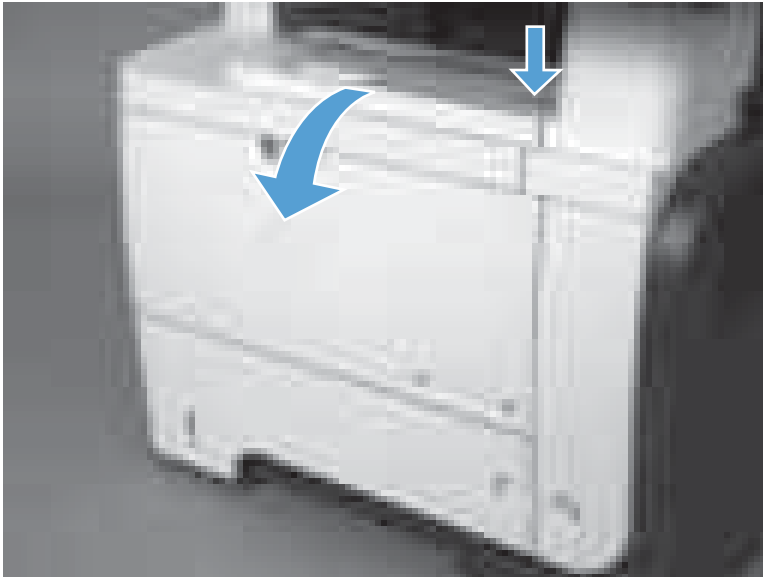
Transfer roller

CAUTION: Do not touch the black-sponge portion of the transfer roller. Skin oils deposited on the transfer roller might cause print-quality problems.

1. Press the cartridge-door release button, and then open the cartridge door. Make sure that the door is completely open.

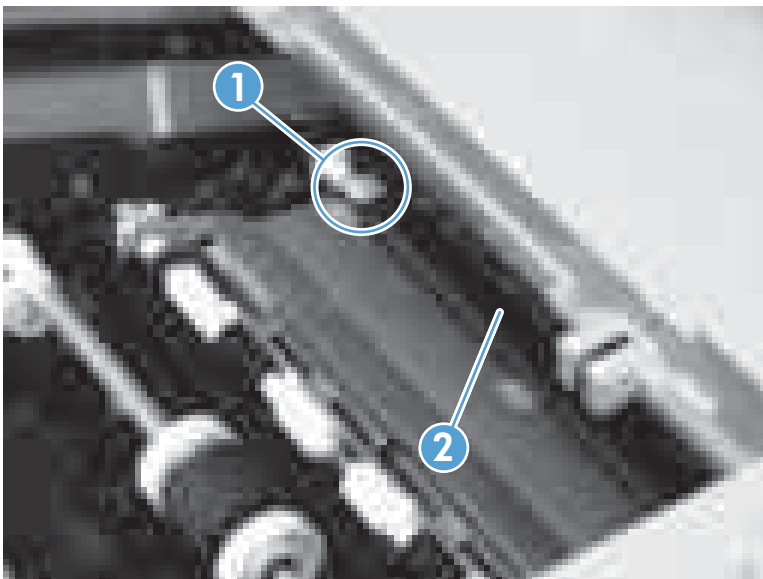
NOTE: If you did not remove the toner cartridge before servicing the product, remove it now.

Figure 1-113 Remove the transfer roller (1 of 3)



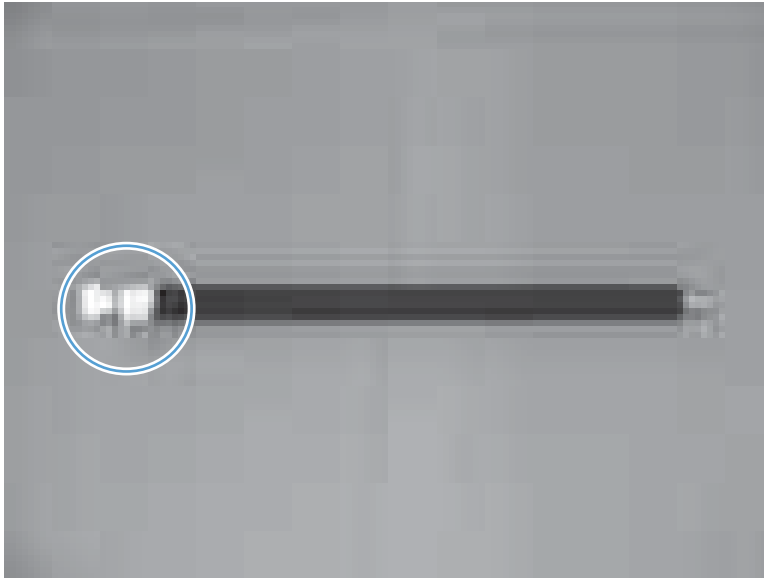
2. Release two tabs (callout 1) at the left end of the roller, slightly lift the end of the roller up, and then slide the roller (callout 2) toward the left to release it. Remove the roller.

Figure 1-114 Remove the transfer roller (2 of 3)



3. If necessary, remove the gear, the bushing, and the spring, and then install them on a replacement roller.

Figure 1-115 Remove the transfer roller (3 of 3)



Fuser

1. Before proceeding, remove the following:
 - Rear cover assembly. See [Rear cover assembly on page 24](#).
 - Right-rear cover. See [Right-rear cover on page 30](#).
2. Release two tabs (callout 1) on the duplex paper-feed guide, and then slide the guide toward the rear of the product to remove it.


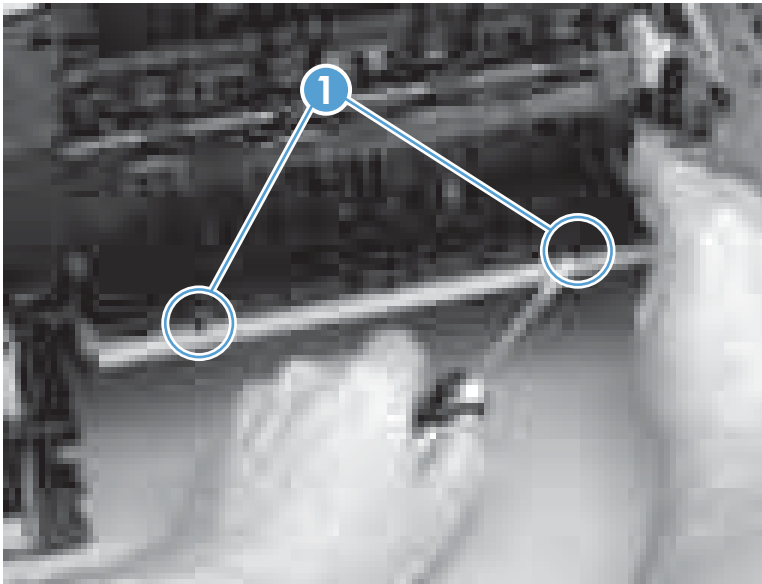
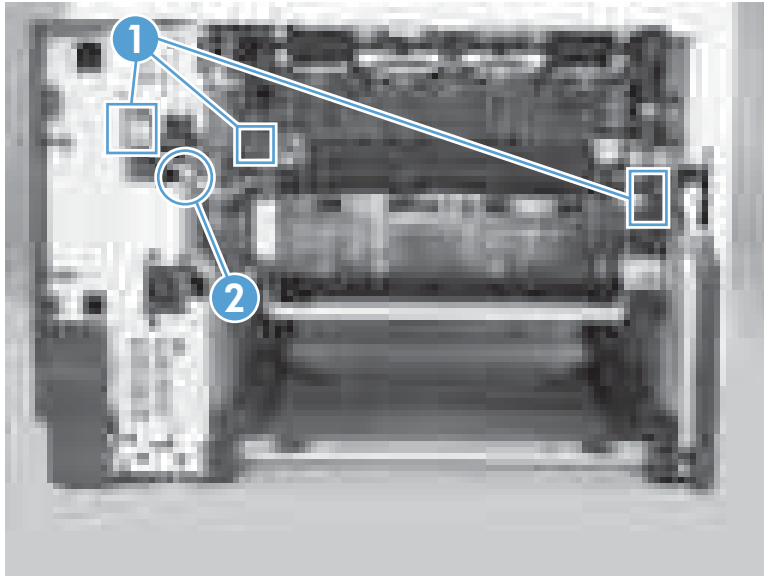
 **Reinstallation tip** Make sure that both tabs snap back into place when reinstalling the duplex paper-feed guide.

Figure 1-116 Remove the fuser (1 of 4)



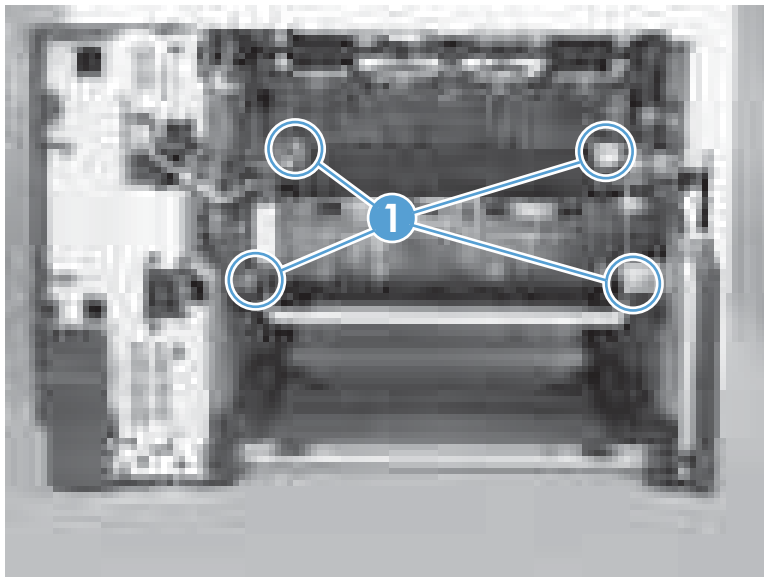
3. Disconnect three connectors (callout 1), and then release one wire harness from the retainer (callout 2).

Figure 1-117 Remove the fuser (2 of 4)



4. Remove four screws (callout 1).

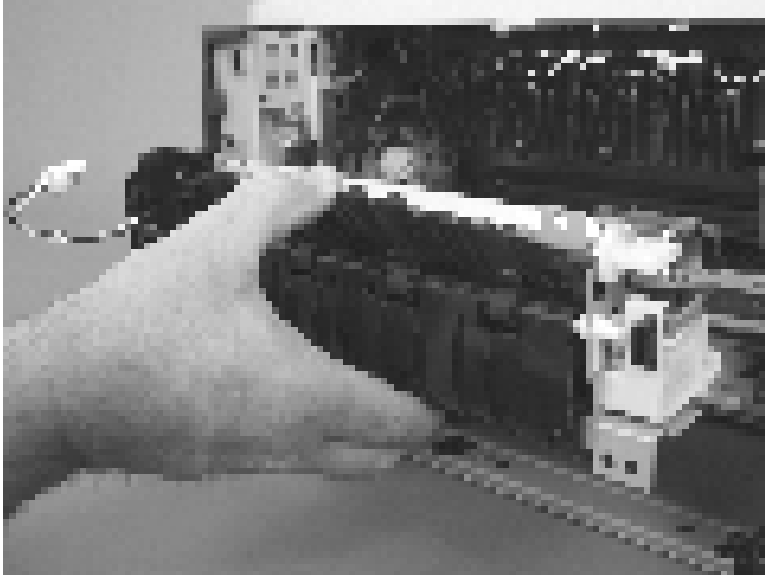
Figure 1-118 Remove the fuser (3 of 4)



5. Pull the fuser out of the back of the product.

⚠ CAUTION: To avoid damaging the fuser, the cartridge-door assembly must be closed before you remove the fuser.

Figure 1-119 Remove the fuser (4 of 4)



Duplex paper-feed assembly

1. Before proceeding, remove the following components:
 - Rear cover assembly. See [Rear cover assembly on page 24](#).
 - Right-rear cover. See [Right-rear cover on page 30](#).
2. Release two tabs (callout 1) on the duplex paper-feed guide, and then slide the guide toward the back of the product to remove it.


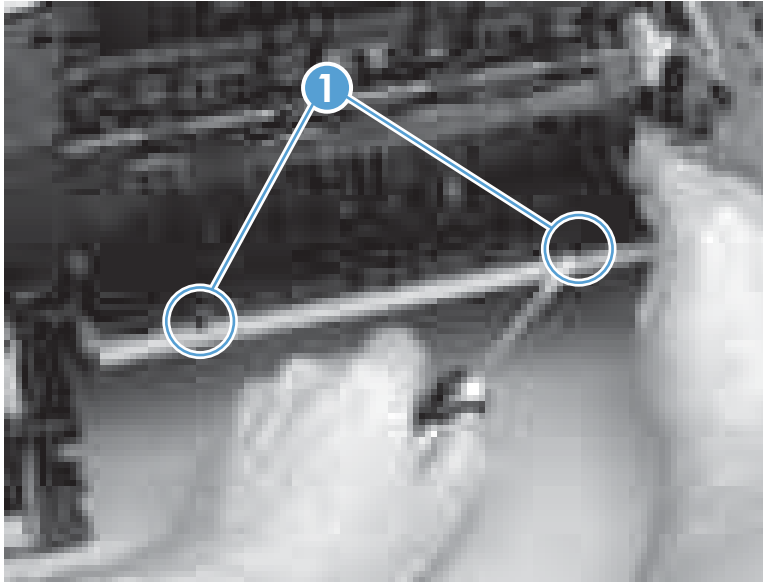
 **Reinstallation tip** Make sure that both tabs snap back into place when reinstalling the duplex paper-feed guide.

Figure 1-120 Remove the duplex paper-feed assembly (1 of 5)



3. Press the green lever (callout 1) to release the duplex paper-feed assembly.

Figure 1-121 Remove the duplex paper-feed assembly (2 of 5)



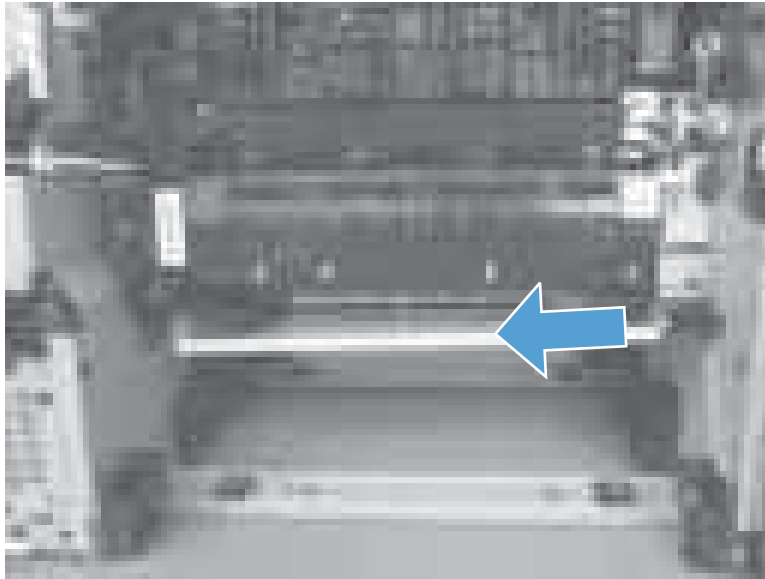
4. Use a small flat-tip screwdriver to carefully pry the sheet-metal tab on the assembly away from the hinge pin to release it.

Figure 1-122 Remove the duplex paper-feed assembly (3 of 5)



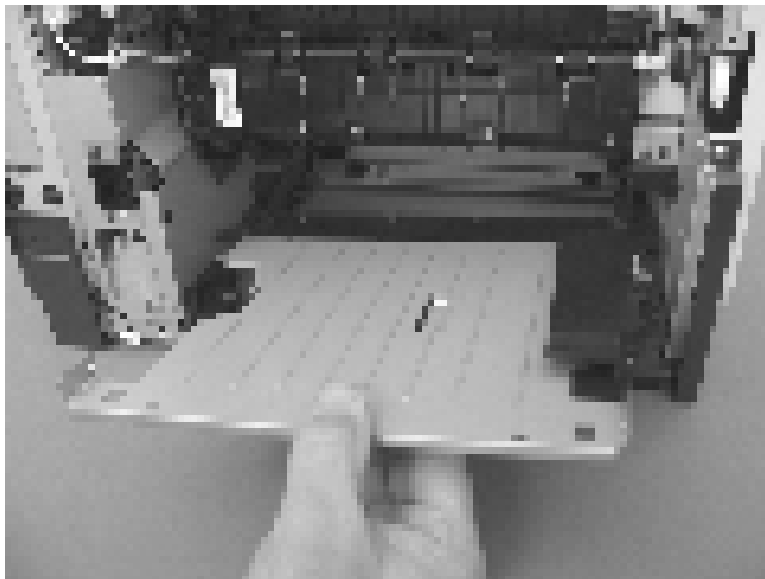
5. Slide the assembly away from the other hinge pin to release it.

Figure 1-123 Remove the duplex paper-feed assembly (4 of 5)



6. Pull the duplex paper-feed assembly out of the back of the product.

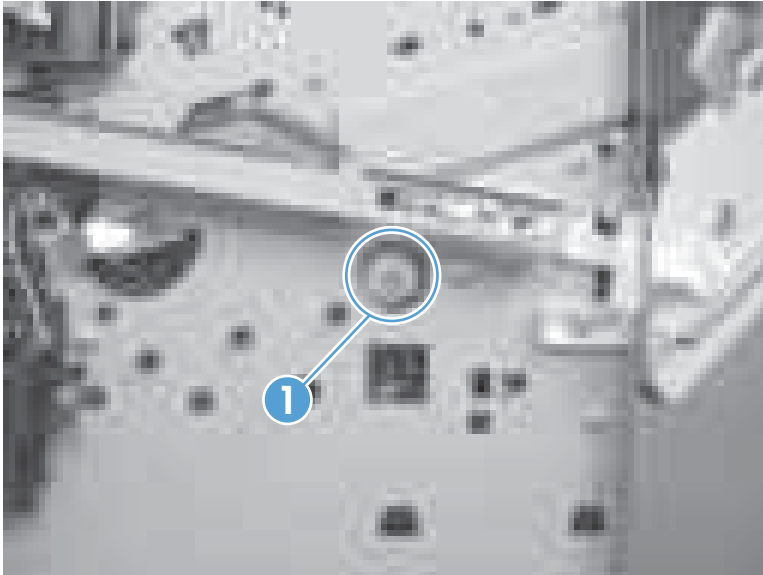
Figure 1-124 Remove the duplex paper-feed assembly (5 of 5)



Registration roller assembly

1. Before proceeding, remove the following components:
 - Rear cover assembly. See [Rear cover assembly on page 24](#).
 - Left cover. See [Left cover on page 28](#).
2. Unhook the clasp on the registration roller assembly gear (callout 1), and then slide the gear off of the shaft.

Figure 1-125 Remove the registration roller assembly (1 of 3)



3. Open the cartridge door, and then remove four screws.

Figure 1-126 Remove the registration roller assembly (2 of 3)



4. Lift the registration roller assembly out of the product, gear-end first.

Figure 1-127 Removing the registration roller assembly (3 of 3)

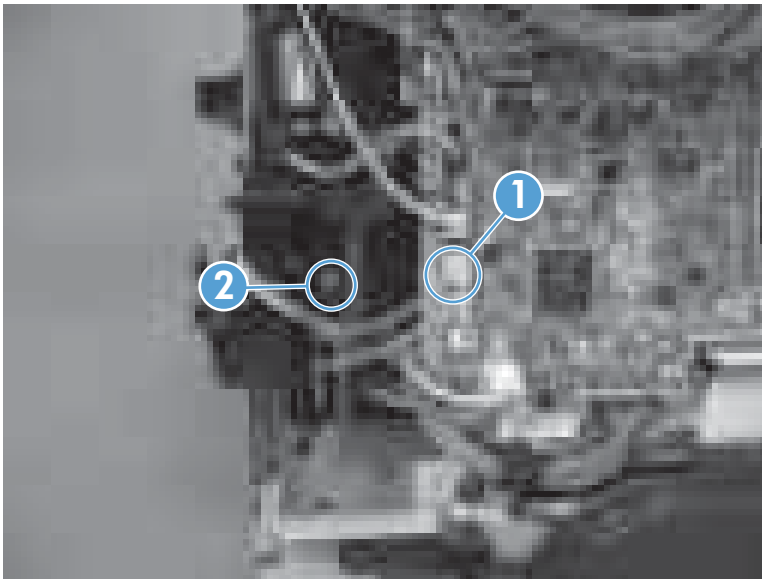


Power-switch assembly

⚠ WARNING!  ESD sensitive component.

1. Before proceeding, remove the following:
 - Formatter cover. See [Formatter cover on page 18](#).
 - Dummy cover. See [Dummy cover on page 23](#)
 - Rear cover assembly. See [Rear cover assembly on page 24](#).
 - Left cover. See [Left cover on page 28](#).
 - Tray 1 cover. See [Tray 1 cover on page 32](#).
 - Cartridge-door assembly. See [Cartridge-door assembly on page 34](#).
 - Right cover assembly. See [Right cover assembly on page 36](#).
2. Disconnect one connector (callout 1), remove one screw (callout 2), and then remove the power-switch assembly.

Figure 1-128 Remove the power-switch assembly (1 of 2)

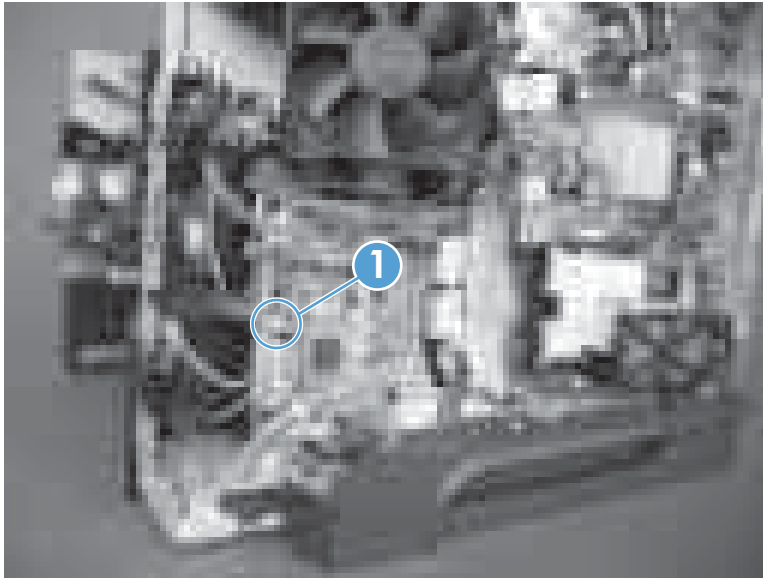


Interlock-switch assembly

⚠ WARNING!  ESD sensitive component.

1. Before proceeding, remove the following:
 - Formatter cover. See [Formatter cover on page 18](#).
 - Dummy cover. See [Dummy cover on page 23](#).
 - Rear cover assembly. See [Rear cover assembly on page 24](#).
 - Left cover. See [Left cover on page 28](#).
 - Tray 1 cover. See [Tray 1 cover on page 32](#).
 - Cartridge-door assembly. See [Cartridge-door assembly on page 34](#).
 - Right cover assembly. See [Right cover assembly on page 36](#).
2. Disconnect one connector (callout 1).

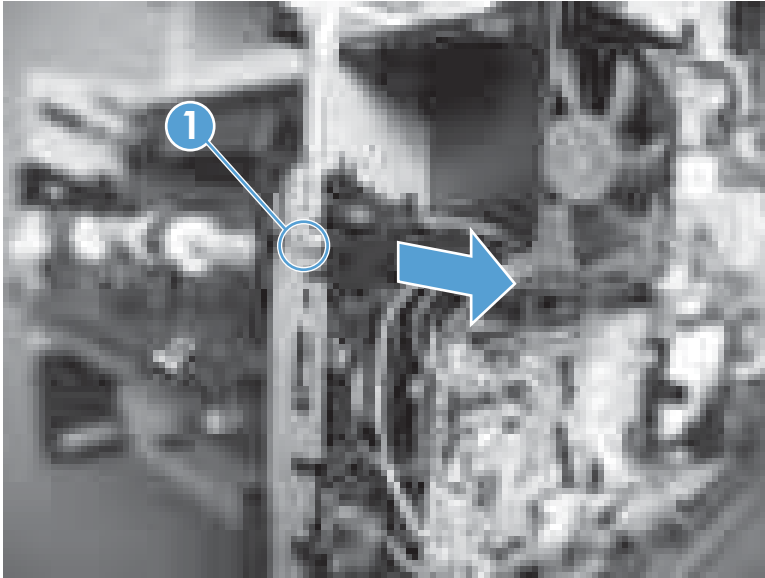
Figure 1-129 Remove the interlock-switch assembly (1 of 3)



3. Remove one screw (callout 1), and then carefully remove the interlock switch assembly.

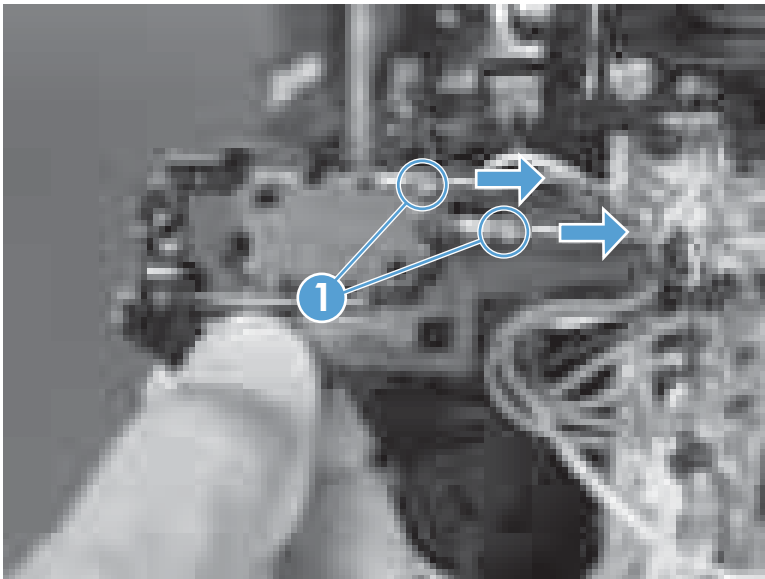
⚠ CAUTION: The interlock switch is still connected to the product by two wires.

Figure 1-130 Remove the interlock-switch assembly (2 of 3)



4. Release two tabs (callout 1), and then carefully remove two wire connectors.

Figure 1-131 Remove the interlock-switch assembly (3 of 3)

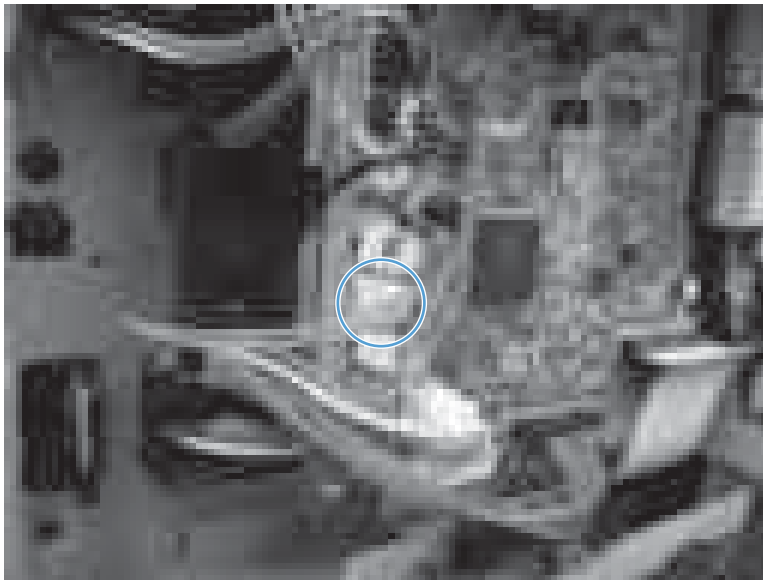


Tray sensor PCA

⚠ WARNING!  ESD sensitive component.

1. Before proceeding, remove the following:
 - Formatter cover. See [Formatter cover on page 18](#).
 - Dummy cover. See [Dummy cover on page 23](#)
 - Rear cover assembly. See [Rear cover assembly on page 24](#).
 - Left cover. See [Left cover on page 28](#).
 - Tray 1 cover. See [Tray 1 cover on page 32](#).
 - Cartridge-door assembly. See [Cartridge-door assembly on page 34](#).
 - Right cover assembly. See [Right cover assembly on page 36](#).
2. Disconnect one connector.

Figure 1-132 Remove the tray sensor PCA (1 of 3)



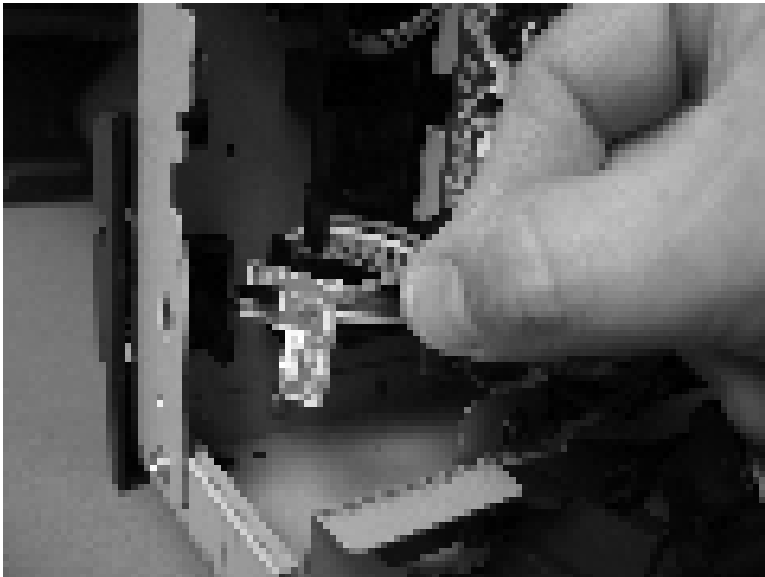
3. Release one tab.

Figure 1-133 Remove the tray sensor PCA (2 of 3)



4. Remove the PCA.

Figure 1-134 Remove the tray sensor PCA (3 of 3)

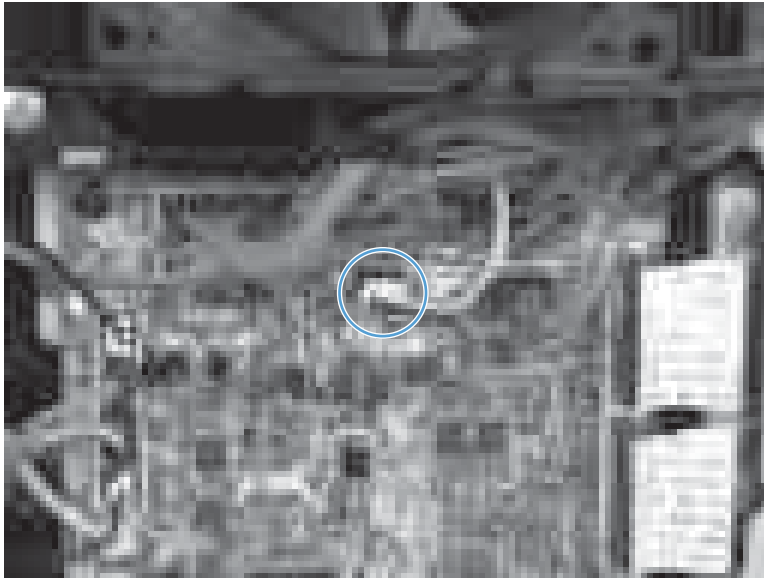


Main fan


⚠ WARNING!  ESD sensitive component.

1. Before proceeding, remove the following:
 - Formatter cover. See [Formatter cover on page 18](#).
 - Dummy cover. See [Dummy cover on page 23](#).
 - Rear cover assembly. See [Rear cover assembly on page 24](#).
 - Left cover. See [Left cover on page 28](#).
 - Tray 1 cover. See [Tray 1 cover on page 32](#).
 - Cartridge-door assembly. See [Cartridge-door assembly on page 34](#).
 - Right cover assembly. See [Right cover assembly on page 36](#).
2. Disconnect one connector and then release the wire harnesses from the retainers.

Figure 1-135 Remove the main fan (1 of 3)

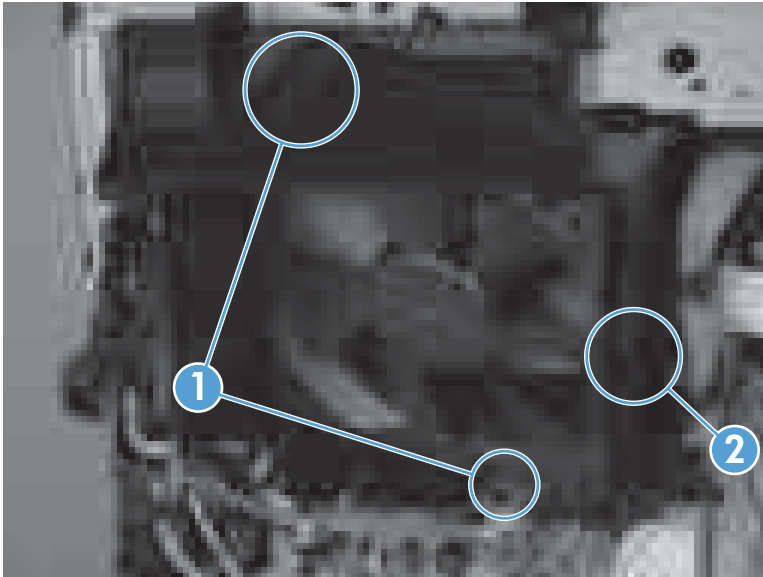


- 3. To remove the main fan only:** Release two tabs (callout 1), and then remove the main fan.

 **Reinstallation tip** A third tab (callout 2) cannot be engaged.

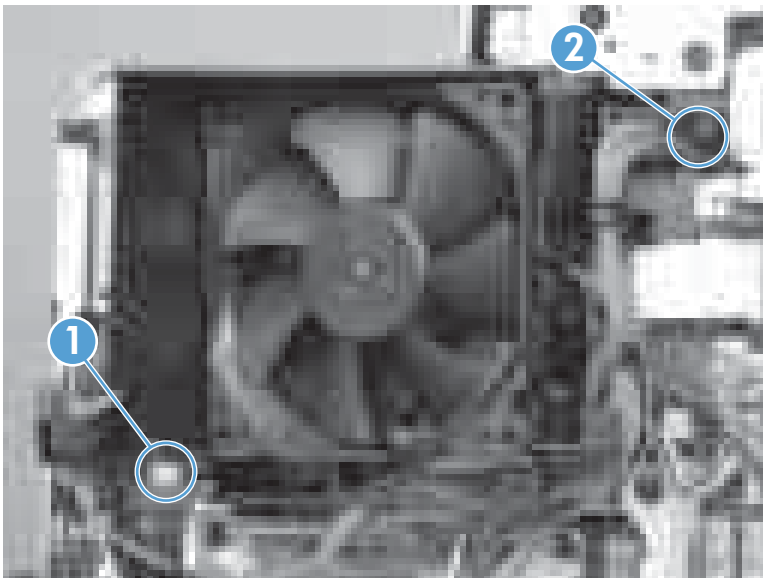
Reinstallation tip **If only the main fan was removed:** When the fan is reinstalled, the air must flow into the product. Make sure that the label side of the fan is toward the inside of the product when the fan is reinstalled.

Figure 1-136 Remove the main fan (2 of 3)



- 4. To remove the main fan and fan duct:** Remove one self-tapping screw (callout 1) and one metal screw (callout 2) and then remove the main fan and fan duct together.

Figure 1-137 Remove the main fan (3 of 3)



Top cover

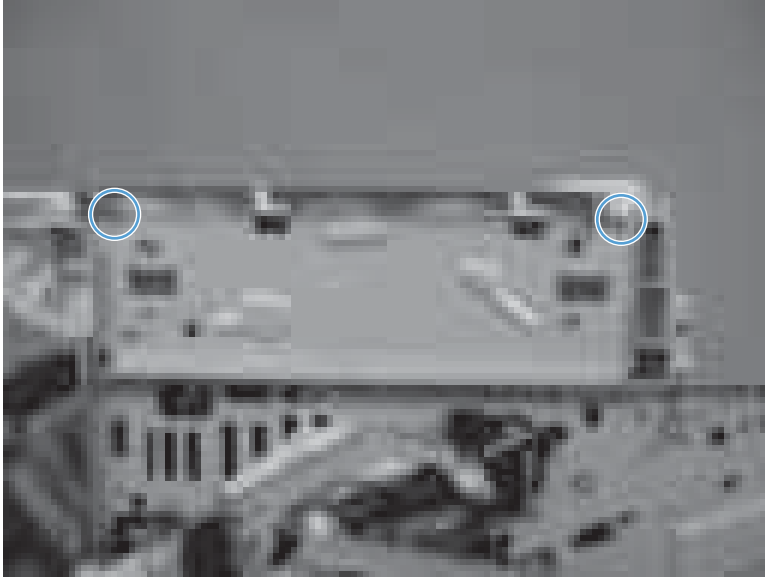
1. Before proceeding, remove the following:
 - Formatter cover. See [Formatter cover on page 18](#).
 - Dummy cover. See [Dummy cover on page 23](#).
 - Rear cover assembly. See [Rear cover assembly on page 24](#).
 - Left cover. See [Left cover on page 28](#).
 - Document feeder/scanner assembly. See [Document feeder/scanner assembly on page 46](#).
2. From the right side of the product, remove two self-tapping screws.

Figure 1-138 Remove the top cover (1 of 4)



3. From the left side of the product, remove two self-tapping screws.

Figure 1-139 Remove the top cover (2 of 4)



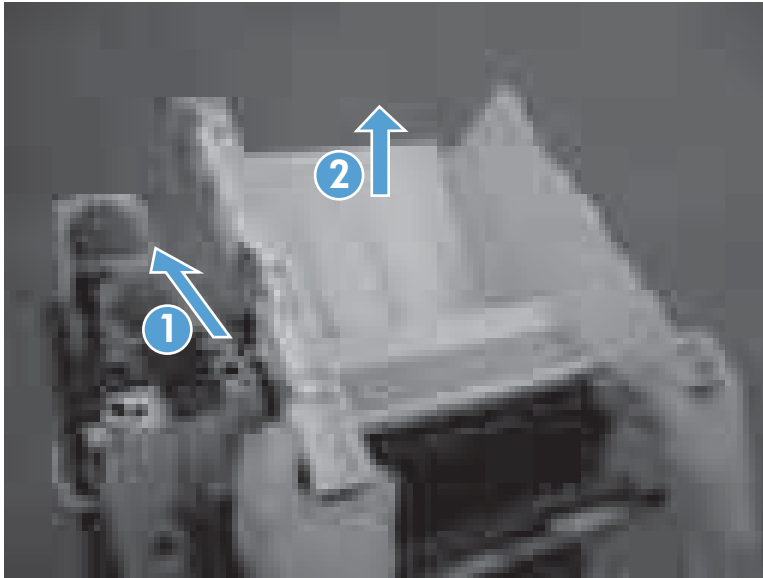
4. Separate each side of the top cover from the chassis.

Figure 1-140 Remove the top cover (3 of 4)



5. Slide cover toward the front of the product (callout 1), and then lift the front of the cover (callout 2) to remove.

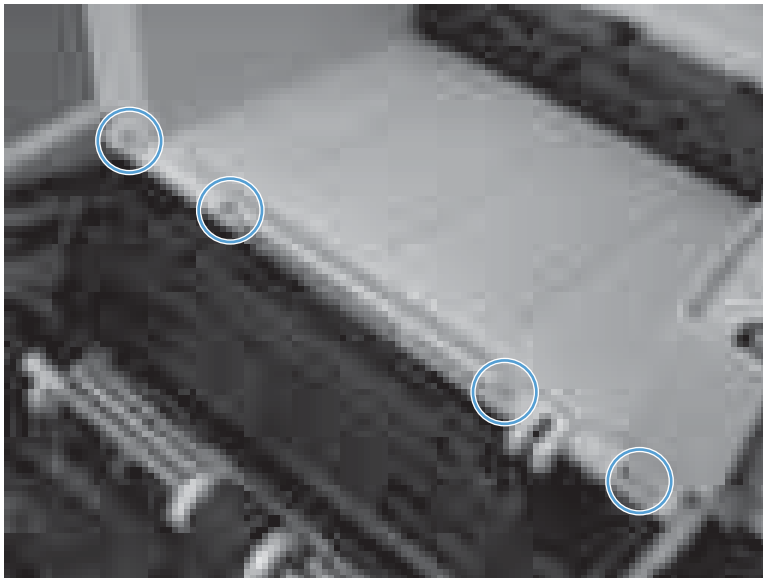
Figure 1-141 Remove the top cover (4 of 4)



Reinstall the top cover

- ▲ Make sure the tabs on the chassis are correctly inserted into the slots on the cover.

Figure 1-142 Reinstall the top cover



Laser scanner

⚠ WARNING!  ESD sensitive component.

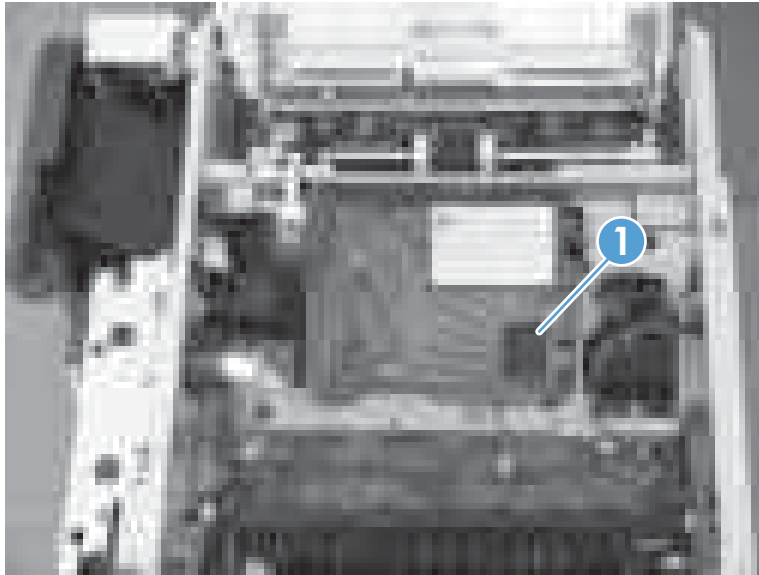
1. Before proceeding, remove the following:
 - Formatter cover. See [Formatter cover on page 18](#).
 - Dummy cover. See [Dummy cover on page 23](#).
 - Rear cover assembly. See [Rear cover assembly on page 24](#).
 - Left cover. See [Left cover on page 28](#).
 - Document feeder/scanner assembly. See [Document feeder/scanner assembly on page 46](#).
 - Top cover. See [Top cover on page 95](#).
2. Release one tab (callout 1) on the air duct, and then lift the air duct (callout 2) out of the product.

Figure 1-143 Remove the laser scanner (1 of 5)



3. Remove the antistatic sponge (callout 1).

Figure 1-144 Remove the laser scanner (2 of 5)



4. Disconnect one connector (callout 1) and one FFC (callout 2).


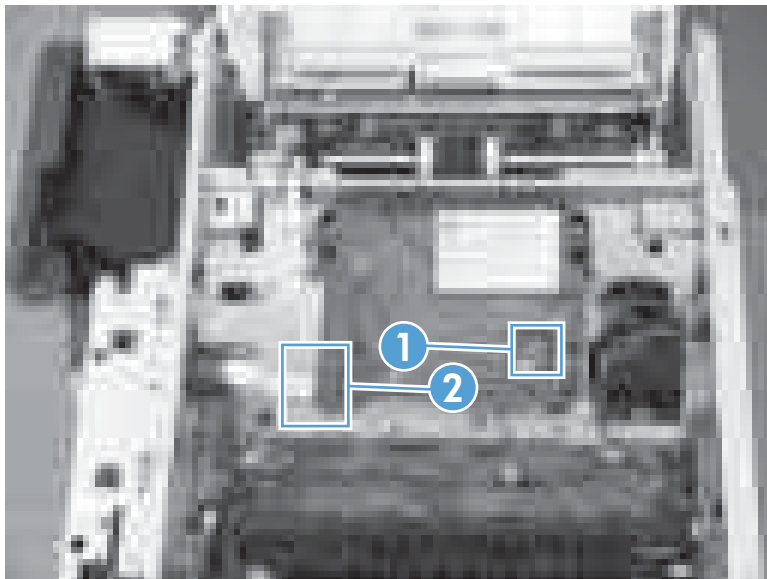
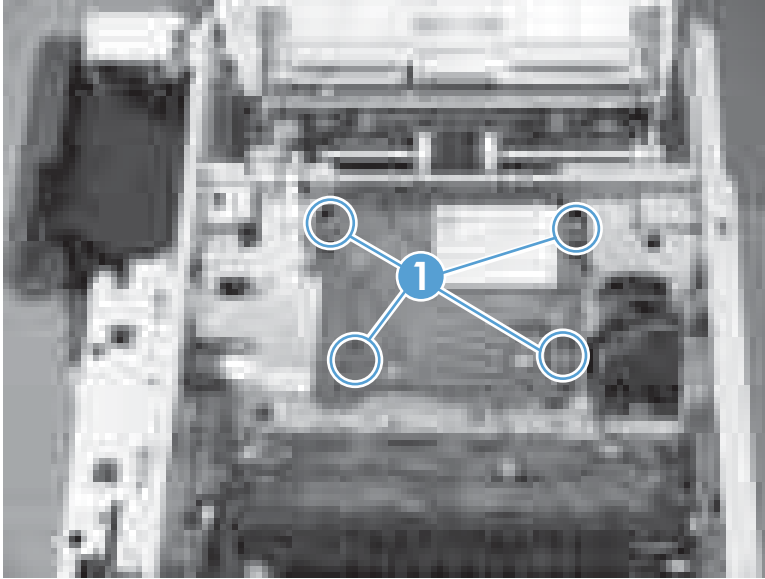
 **Reinstallation tip** Make sure that you correctly reconnect the FFC when the laser scanner is installed. If the FFC is not correctly reconnected, a **51.1 ERROR** will appear on the control-panel display.

Figure 1-145 Remove the laser scanner (3 of 5)



5. Remove four screws (callout 1).

Figure 1-146 Remove the laser scanner (4 of 5)



6. Lift the laser scanner up and out of the product.

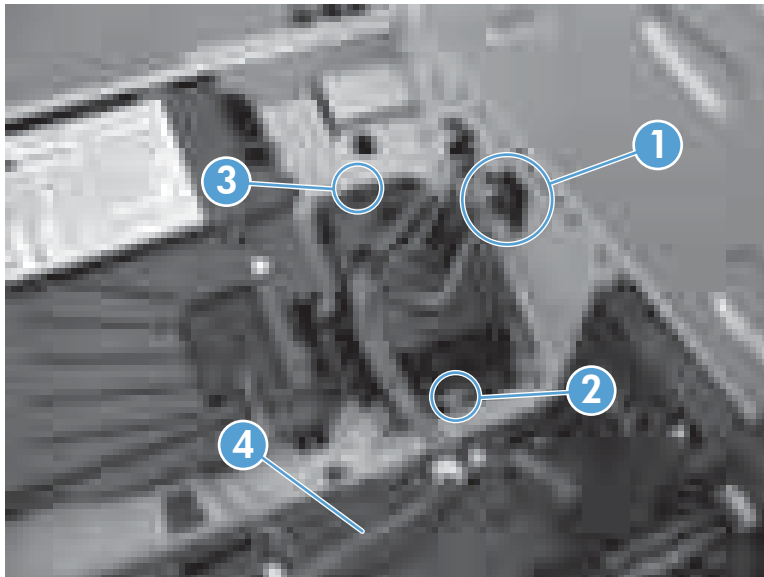
Figure 1-147 Remove the laser scanner (5 of 5)



Tag holder assembly

1. Before proceeding, remove the following:
 - Formatter cover. See [Formatter cover on page 18](#).
 - Dummy cover. See [Dummy cover on page 23](#).
 - Rear cover assembly. See [Rear cover assembly on page 24](#).
 - Left cover. See [Left cover on page 28](#).
 - Document feeder/scanner assembly. See [Document feeder/scanner assembly on page 46](#).
 - Top cover. See [Top cover on page 95](#).
2. Disconnect one connector (callout 1), remove one screw (callout 2), and release one tab (callout 3). Release the wire harness (callout 4) from its holders and the DC controller, and then remove the tag holder assembly.

Figure 1-148 Remove the tag holder assembly



DC controller

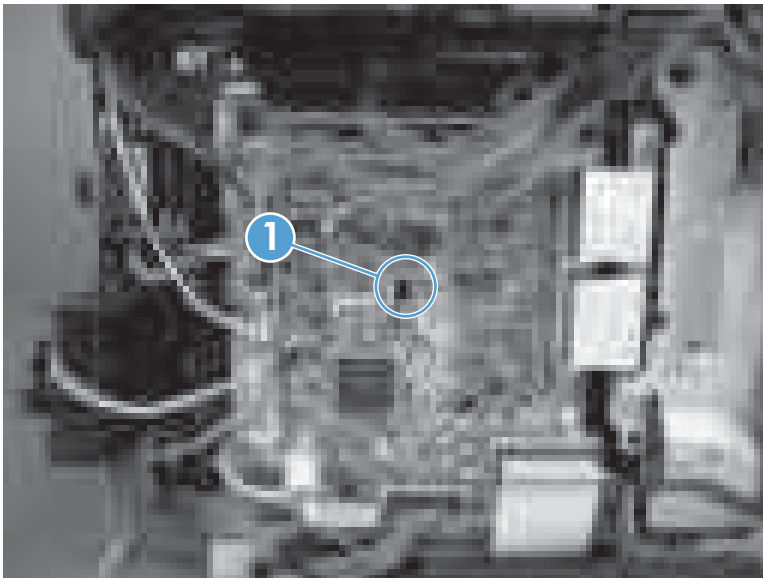
⚠ WARNING!  ESD sensitive component.

1. Before proceeding, remove the following:
 - Formatter cover. See [Formatter cover on page 18](#).
 - Dummy cover. See [Dummy cover on page 23](#).
 - Rear cover assembly. See [Rear cover assembly on page 24](#).
 - Left cover. See [Left cover on page 28](#).
 - Tray 1 cover. See [Tray 1 cover on page 32](#).
 - Cartridge-door assembly. See [Cartridge-door assembly on page 34](#).
 - Right cover assembly. See [Right cover assembly on page 36](#).
 - Lower right cover. See [Lower right cover on page 41](#).
2. Disconnect 17 connectors and three FFCs.

 **NOTE:** One connector (callout 1) remains empty.

 **NOTE:** To locate DC controller connector locations, see [DC controller connections on page 7](#).

Figure 1-149 Remove the DC controller (1 of 6)



3. Release two tabs, and then carefully remove two wire connectors from the interlock switch assembly.


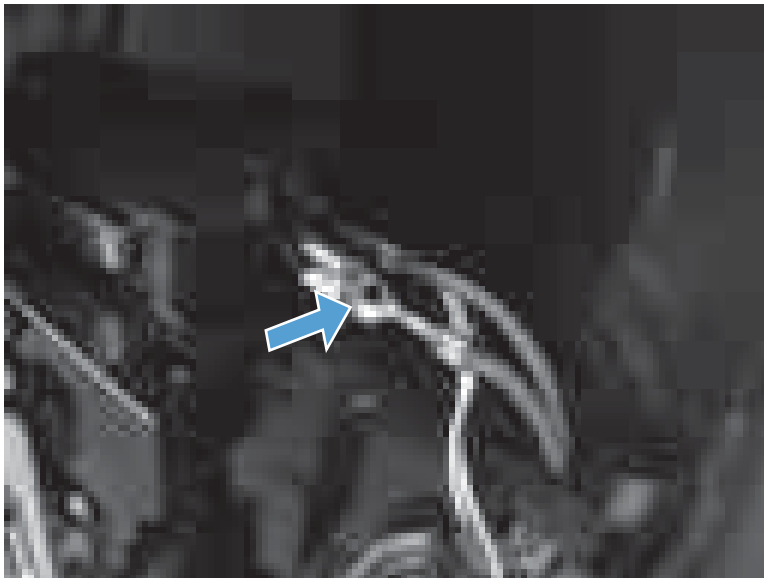
 **TIP:** It might be easier to release these connectors by first removing the interlock switch. See [Interlock-switch assembly on page 89](#).

Figure 1-150 Remove the DC controller (2 of 6)

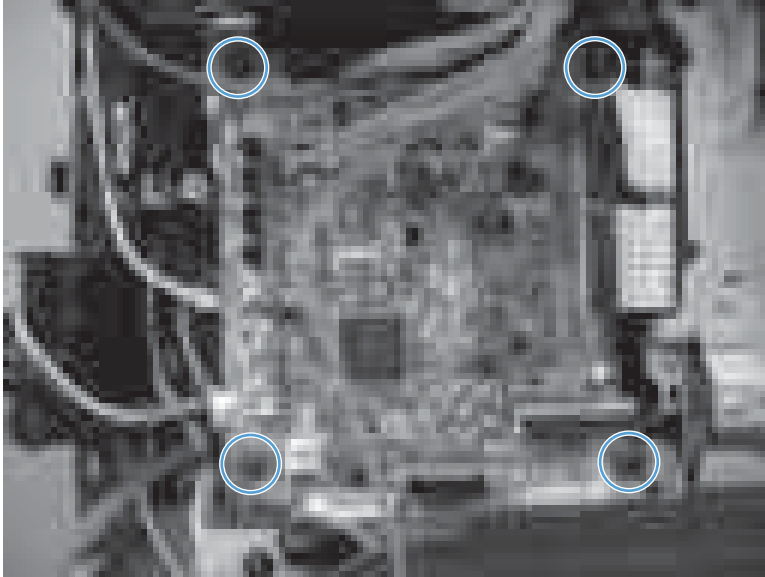


Figure 1-151 Remove the DC controller (3 of 6)



4. **DC controller only:** Remove four screws and then remove the PCA.

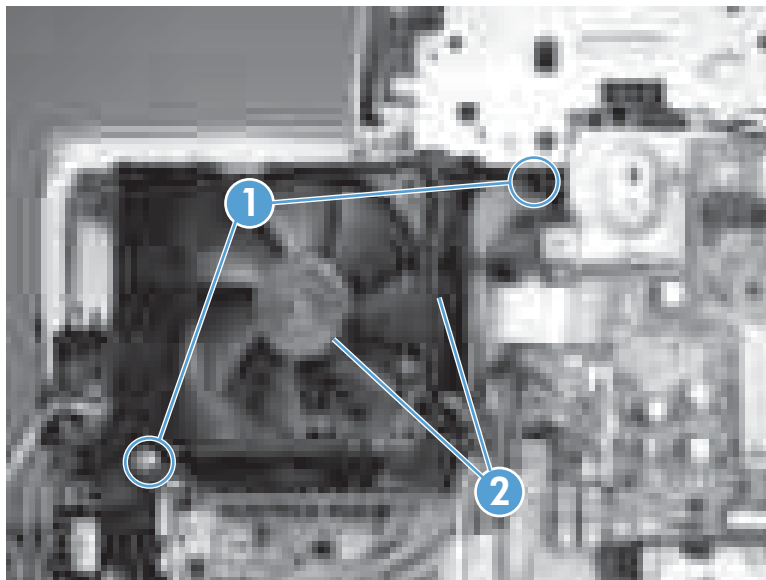
Figure 1-152 Remove the DC controller (4 of 6)



5. **DC controller and sheet-metal plate:** Do the following.

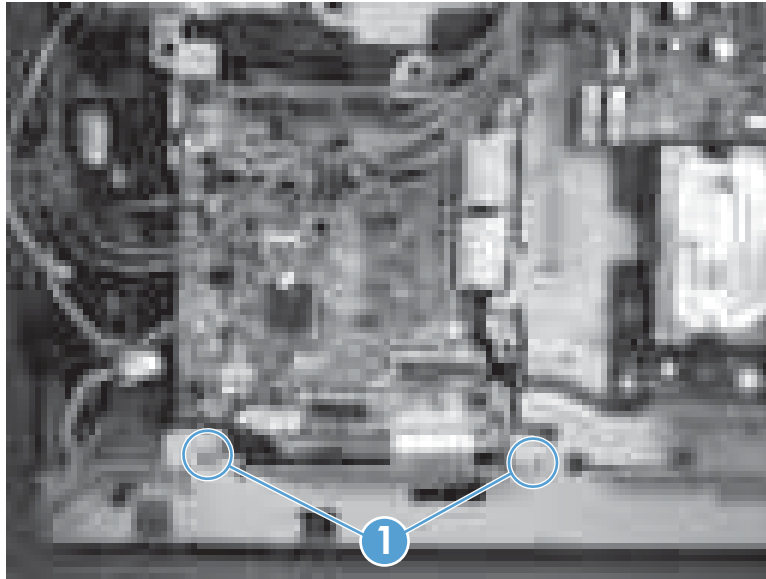
- a. Remove two screws (callout 1), and then remove the fan and duct assembly (callout 2).

Figure 1-153 Remove the DC controller (5 of 6)



- b. Remove two screws (callout 1), and then remove the PCA and sheet-metal plate.

Figure 1-154 Remove the DC controller (6 of 6)

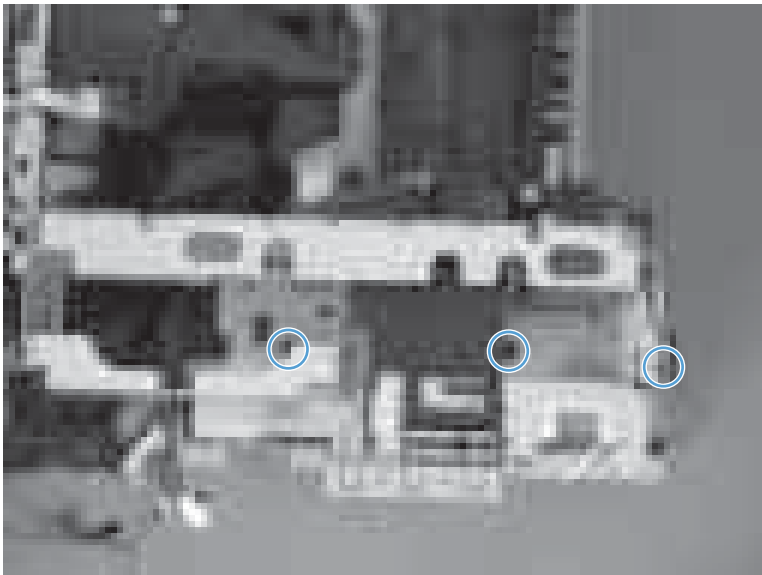


Low-voltage power supply (LVPS)

⚠ WARNING!  ESD sensitive component.

1. Before proceeding, remove the following:
 - Formatter cover. See [Formatter cover on page 18](#).
 - Dummy cover. See [Dummy cover on page 23](#).
 - Formatter PCA. See [Formatter PCA on page 19](#).
 - Rear cover assembly. See [Rear cover assembly on page 24](#).
 - Left cover. See [Left cover on page 28](#).
 - Right-rear cover. See [Right-rear cover on page 30](#).
 - Tray 1 cover. See [Tray 1 cover on page 32](#).
 - Cartridge-door assembly. See [Cartridge-door assembly on page 34](#).
 - Right cover assembly. See [Right cover assembly on page 36](#).
 - Lower right cover. See [Lower right cover on page 41](#).
 - Document feeder/scanner assembly. See [Document feeder/scanner assembly on page 46](#).
 - Top cover. See [Top cover on page 95](#).
2. Remove three screws.

Figure 1-155 Remove the LVPS (1 of 10)



3. Remove one screw (callout 1), the wire harness holder (callout 2), and the sheet-metal bracket (callout 3).


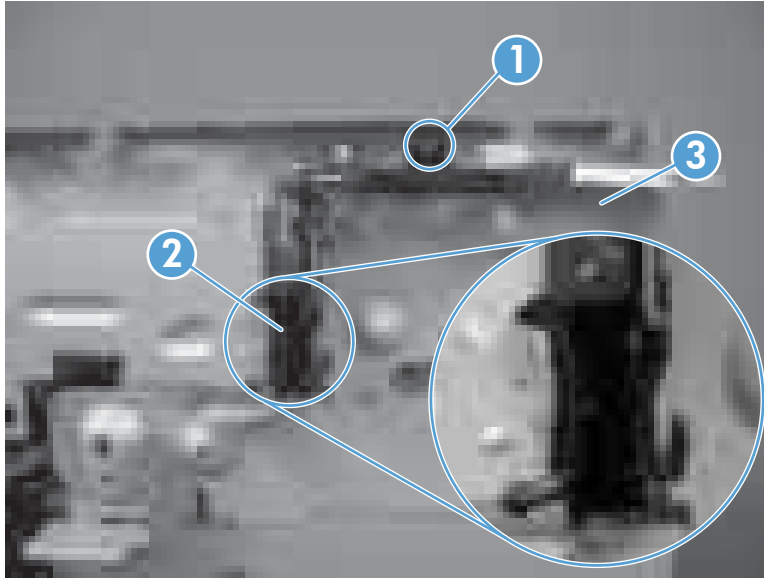
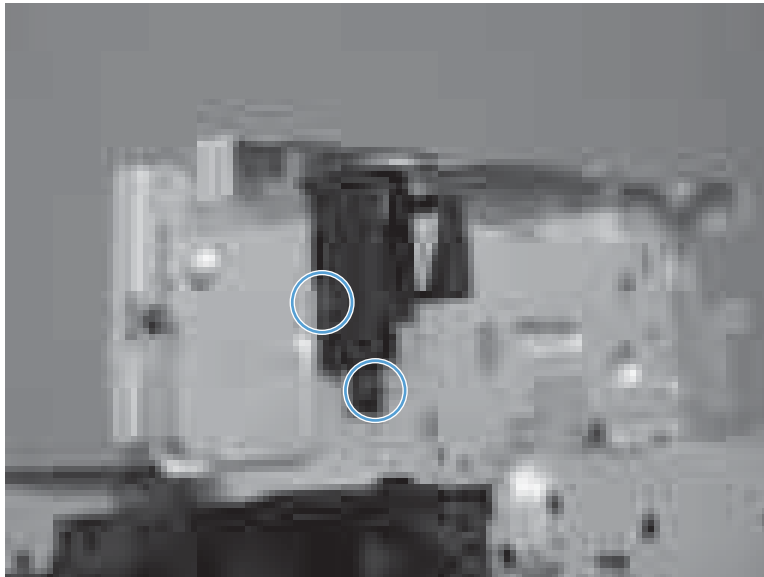
 **TIP:** If the wire harness holder (callout 2) becomes dislodged, replace it as shown below.

Figure 1-156 Remove the LVPS (2 of 10)



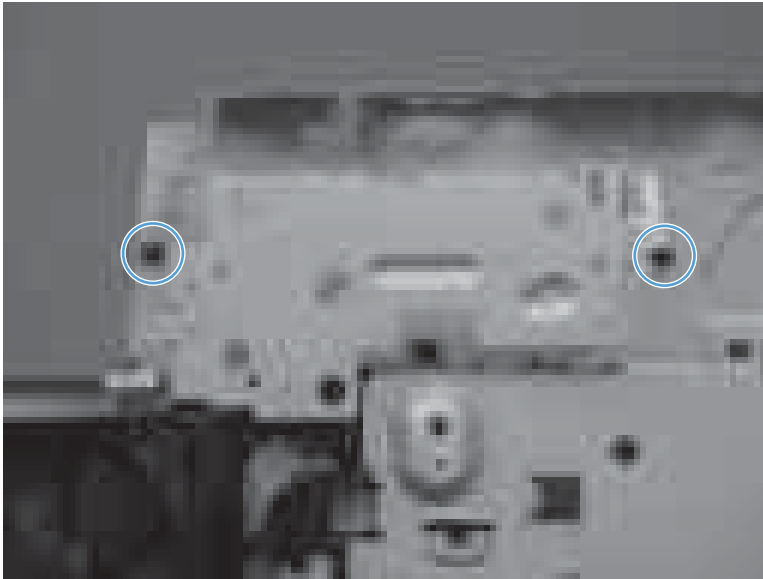
4. Remove two screws and the plastic retainer.

Figure 1-157 Remove the LVPS (3 of 10)



5. Remove two screws and the sheet metal bracket.

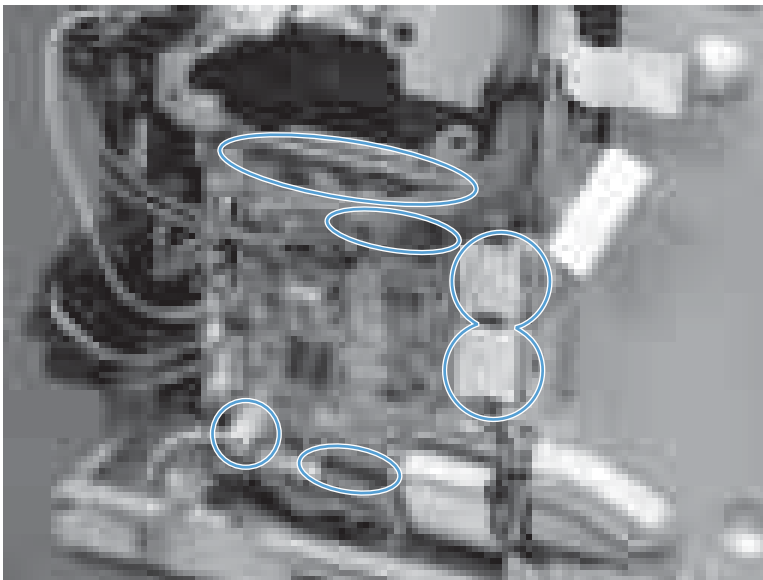
Figure 1-158 Remove the LVPS (4 of 10)



6. Remove the main fan. See [Main fan on page 93](#).
7. Disconnect eight connectors and two FFCs from the DC controller.

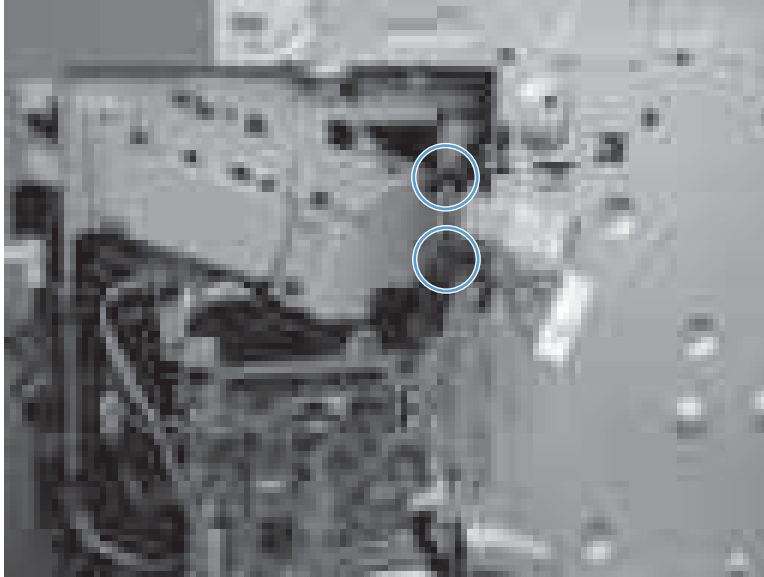
 **NOTE:** To locate DC controller connector locations, see [DC controller connections on page 7](#).

Figure 1-159 Remove the LVPS (5 of 10)



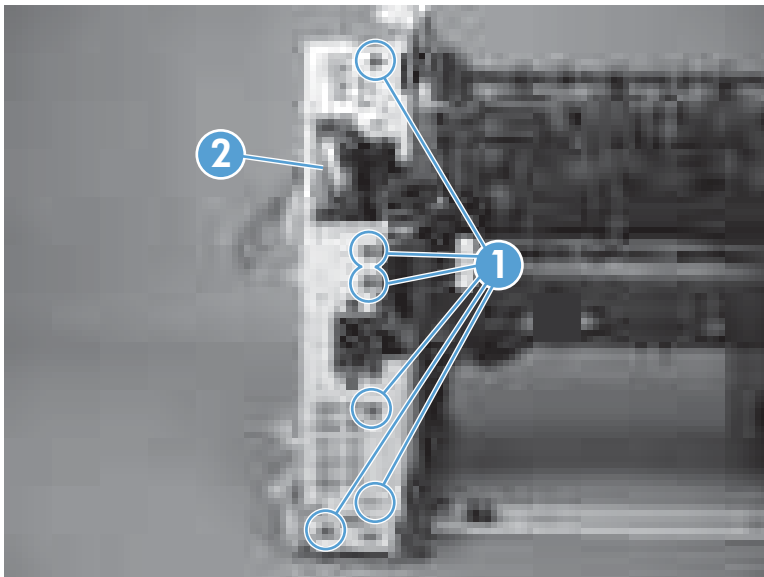
8. Release the wire harness from the holders.

Figure 1-160 Remove the LVPS (6 of 10)



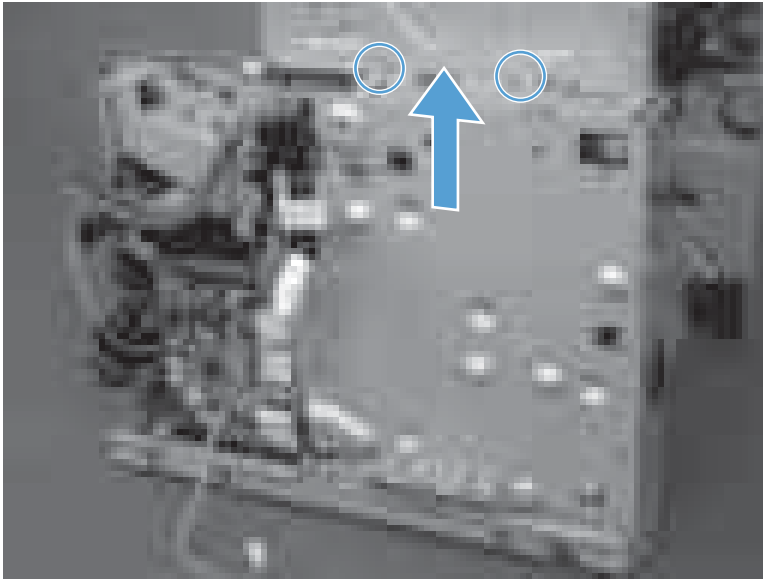
9. Remove six screws (callout 1) and disconnect one connector (callout 2).

Figure 1-161 Remove the LVPS (7 of 10)



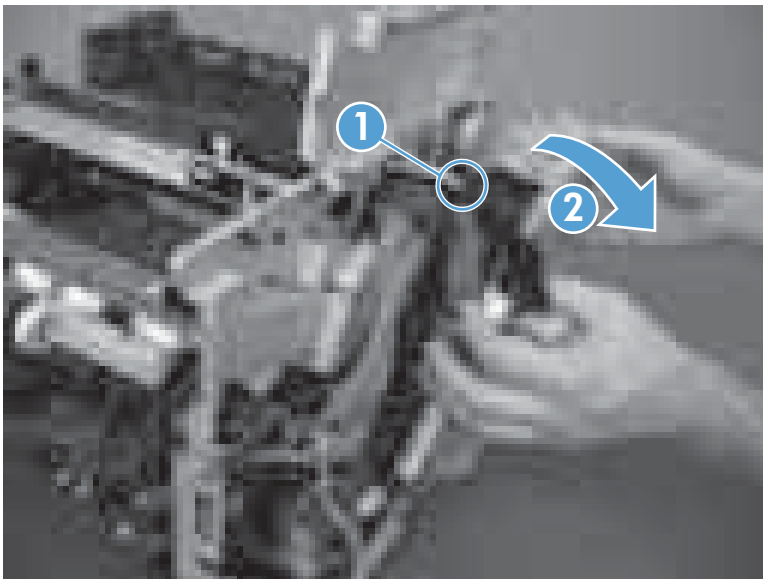
10. Lift the LVPS to clear two tabs.


Figure 1-162 Remove the LVPS (8 of 8)



11. Tip the LVPS away from the product (callout 1) and then disconnect one FFC (callout 2).

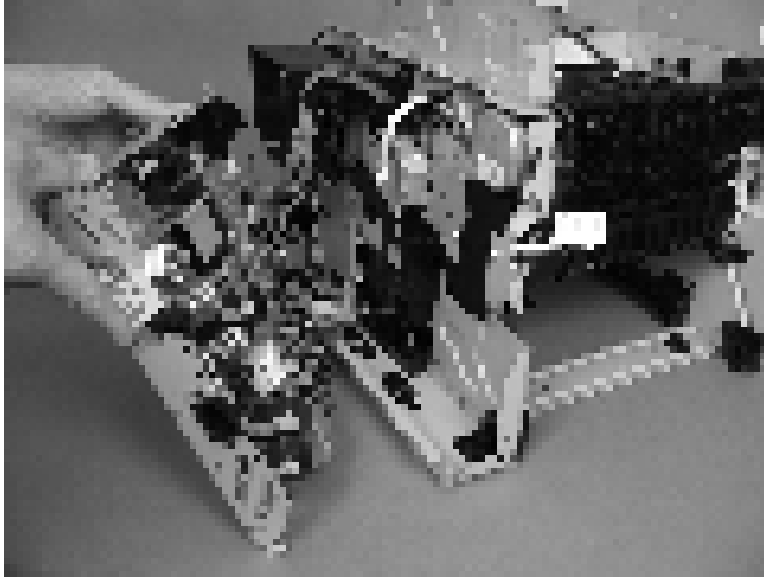
Figure 1-163 Remove the LVPS (9 of 10)



 **Reinstallation tip** Make sure to reconnect the FFC. A 51 error will occur if it is not connected.

12. Remove the LVPS.

Figure 1-164 Remove the LVPS (10 of 10)



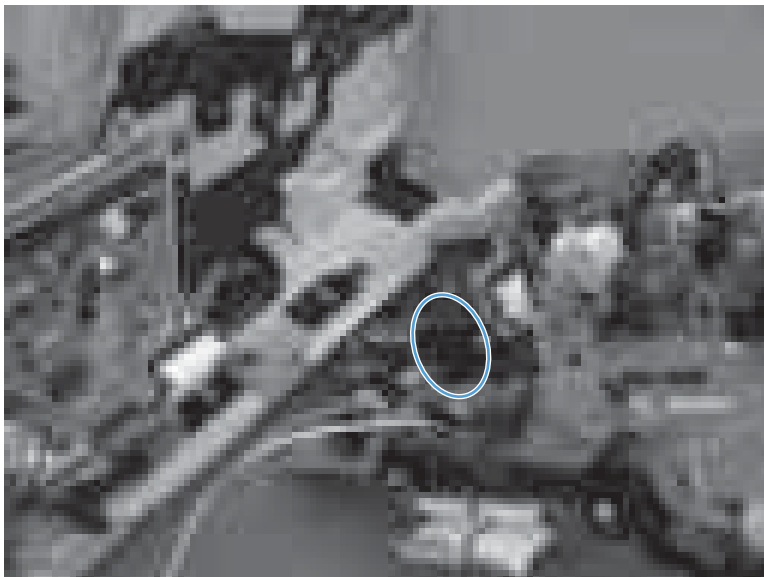
Reinstall the LVPS

- ▲ The black plastic cap can become dislodged when removing the LVPS. Reattach the cap before reinstalling the assembly.



NOTE: Be sure to reconnect the FFC. A 51 error will occur if it is not connected.

Figure 1-165 Reinstall the LVPS



Tray 2 paper pickup assembly

1. Before proceeding, remove the following:
 - Formatter cover. See [Formatter cover on page 18](#).
 - Dummy cover. See [Dummy cover on page 23](#).
 - Rear cover assembly. See [Rear cover assembly on page 24](#).
 - Left cover. See [Left cover on page 28](#).
 - Right-rear cover. See [Right-rear cover on page 30](#).
 - Tray 1 cover. See [Tray 1 cover on page 32](#).
 - Right cover assembly. See [Right cover assembly on page 36](#).
 - Cartridge-door assembly. See [Cartridge-door assembly on page 34](#).
 - Lower right cover. See [Lower right cover on page 41](#).
 - Document feeder/scanner assembly. See [Document feeder/scanner assembly on page 46](#).
 - Duplex paper-feed assembly. See [Duplex paper-feed assembly on page 83](#).
 - Top cover. See [Top cover on page 95](#).
 - DC controller. See [DC controller on page 102](#).
 - Low-voltage power supply. See [Low-voltage power supply \(LVPS\) on page 106](#).

2. Turn the product on its side. Remove one screw (callout 1).


 **NOTE:** In this figure the gear cover is shown removed for clarity. Do not remove the gear cover yet. The gears behind the cover are not captive and can easily be dislodged if the cover is removed at this time.

Figure 1-166 Remove the Tray 2 paper pickup assembly (1 of 10)



3. Remove one screw (callout 1), and then remove the base-plate (callout 2).


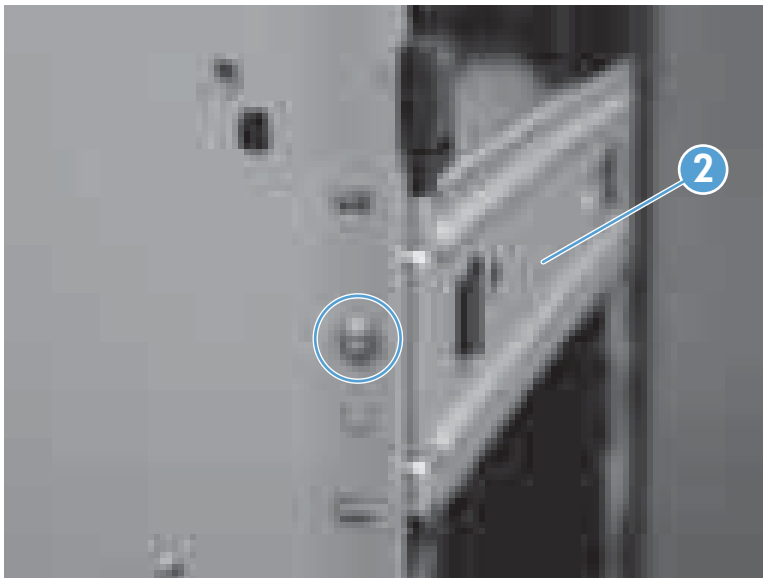
 **Reinstallation tip** Be sure to correctly align the base-plate. It should match the base-plate at the rear of the product.

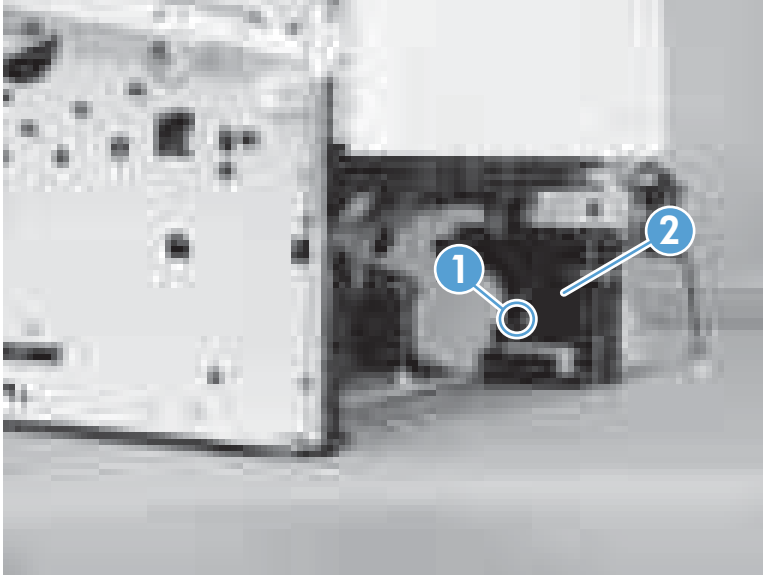
Figure 1-167 Remove the Tray 2 paper pickup assembly (2 of 10)



4. Remove one screw (callout 1), and then carefully remove the right-side guide (callout 2).

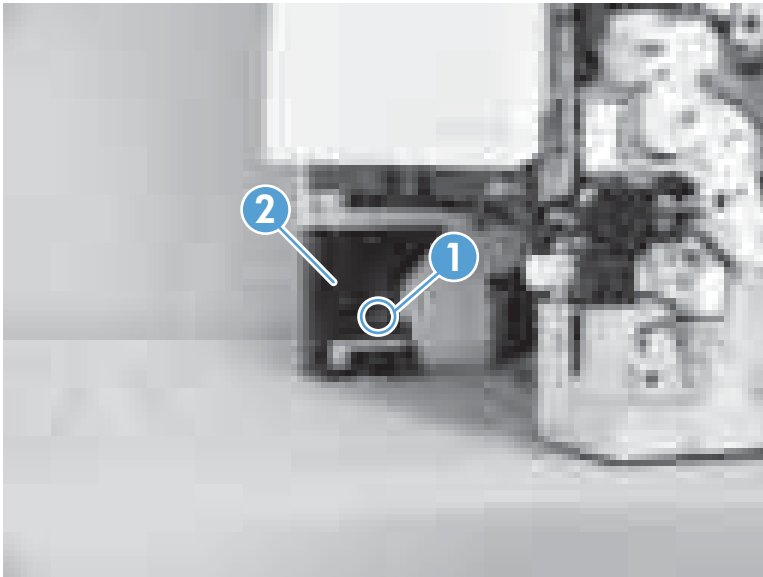
⚠ CAUTION: Remove the guide carefully. The solenoid and cable remain attached to the guide during removal.

Figure 1-168 Remove the Tray 2 paper pickup assembly (3 of 10)



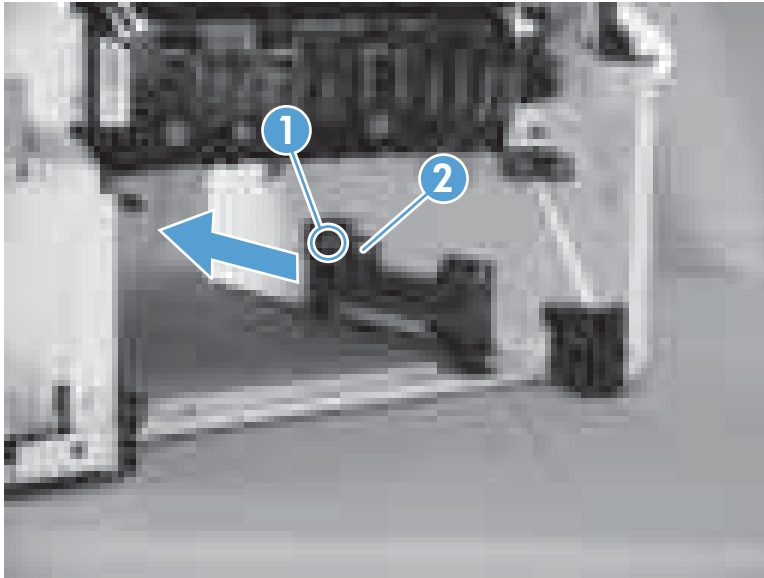
5. Remove one screw (callout 1), and then remove the left-side guide (callout 2).

Figure 1-169 Remove the Tray 2 paper pickup assembly (4 of 10)



6. Remove one screw (callout 1), release one tab (callout 2), and then slide the guide toward the front of the product to release it. Remove the guide.

Figure 1-170 Remove the Tray 2 paper pickup assembly (5 of 10)



7. Put the product on its side so that the gear cover faces up. Remove three screws (callout 1) and the gear cover.


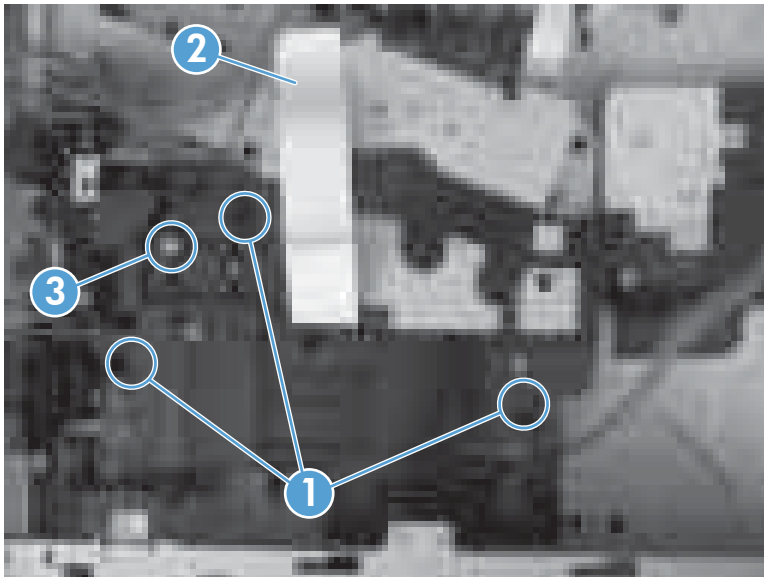
 **Reinstallation tip** Note the location of the FFC (callout 2) and the shaft (callout 3) for reinstallation.

Figure 1-171 Remove the Tray 2 paper pickup assembly (6 of 10)



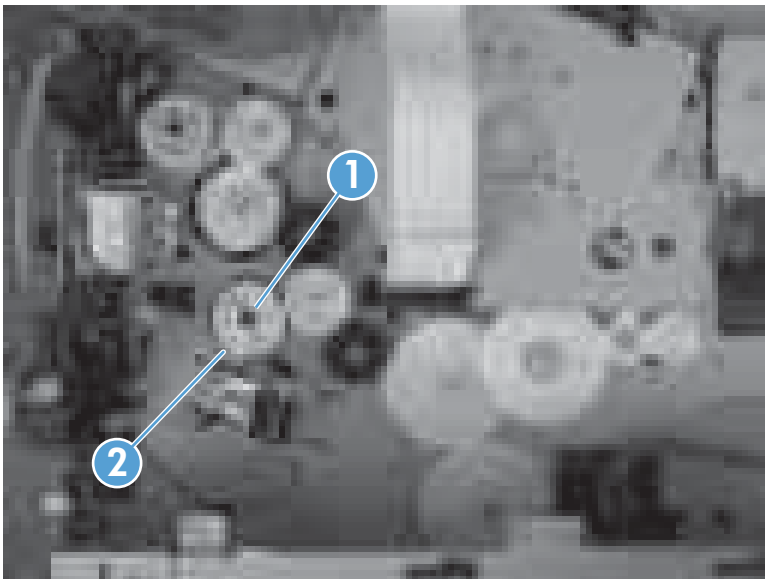
8. Disconnect one connector.

Figure 1-172 Remove the Tray 2 paper pickup assembly (7 of 10)



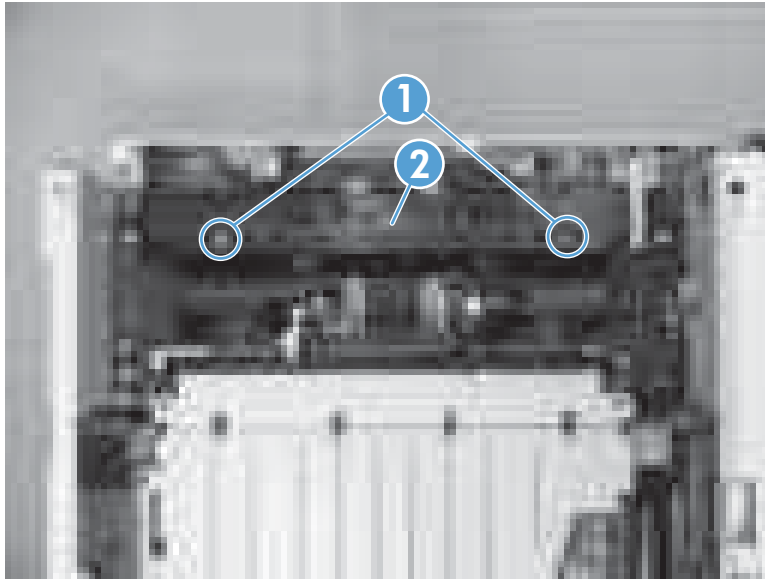
9. Release one tab (callout 1), and then remove one gear (callout 2).

Figure 1-173 Remove the Tray 2 paper pickup assembly (8 of 10)



10. Remove two screws (callout 1) and the idler roller assembly (callout 2).

Figure 1-174 Remove the Tray 2 paper pickup assembly (9 of 10)



11. Remove four screws and the Tray 2 paper pickup assembly. Rotate the left side of the assembly away from the product first, and then remove the right side of the assembly.


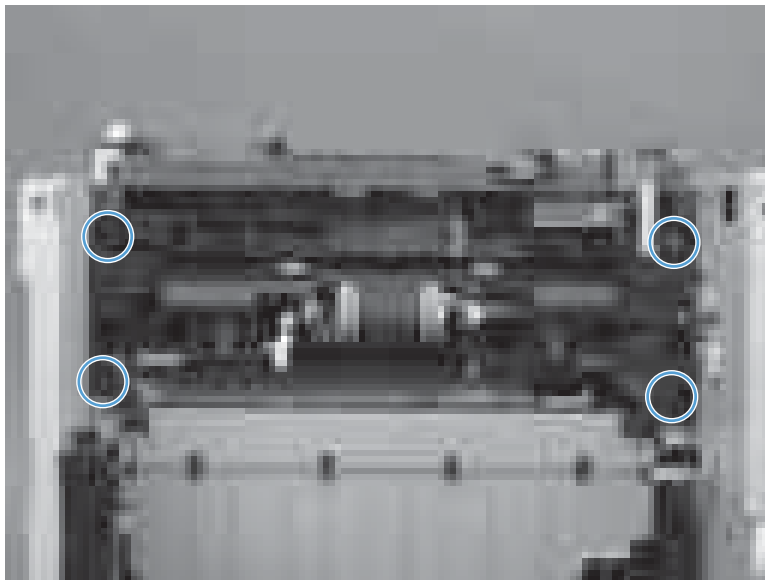
 **Reinstallation tip** Reinstall the right side of the assembly first and then install the left side of the assembly.

Figure 1-175 Remove the Tray 2 paper pickup assembly (10 of 10)



Tray 1 or Tray 2 pickup solenoid

1. Before proceeding, remove the following:
 - Formatter cover. See [Formatter cover on page 18](#).
 - Dummy cover. See [Dummy cover on page 23](#).
 - Formatter PCA. See [Formatter PCA on page 19](#).
 - Rear cover assembly. See [Rear cover assembly on page 24](#).
 - Left cover. See [Left cover on page 28](#).
 - Right-rear cover. See [Right-rear cover on page 30](#).
 - Tray 1 cover. See [Tray 1 cover on page 32](#).
 - Cartridge-door assembly. See [Cartridge-door assembly on page 34](#).
 - Right cover assembly. See [Right cover assembly on page 36](#).
 - Lower right cover. See [Lower right cover on page 41](#).
 - Document feeder/scanner assembly. See [Document feeder/scanner assembly on page 46](#).
 - Top cover. See [Top cover on page 95](#).
 - DC controller. See [DC controller on page 102](#).
 - Low-voltage power supply. See [Low-voltage power supply \(LVPS\) on page 106](#).
2. Carefully unwind the wire harness (callout 1) from the retainer on the gear cover (callout 2).


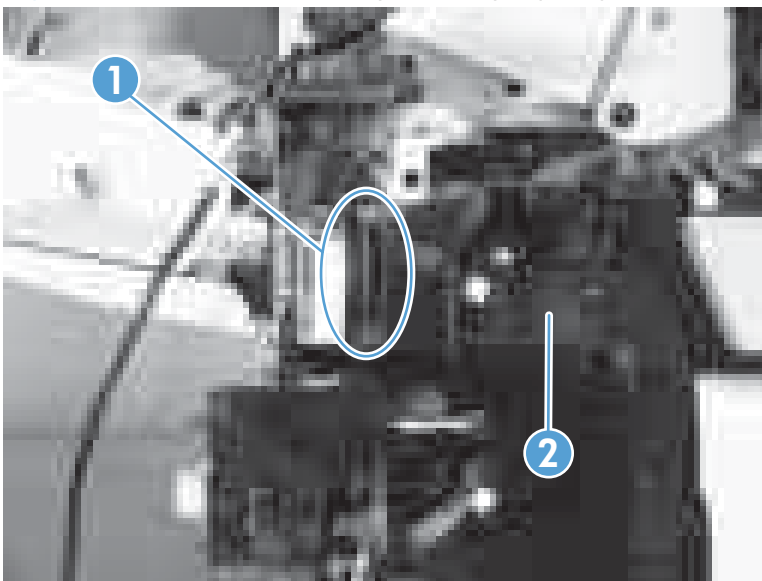
 **Reinstallation tip** When you reinstall the gear cover, make sure that you wrap the solenoid-wire harness around the retainer one and one-half times in a clockwise direction.

Figure 1-176 Remove the Tray 1 or Tray 2 pickup solenoid (1 of 3)



- Put the product on its side so that the gear cover faces up. Remove three screws (callout 1) and the gear cover.


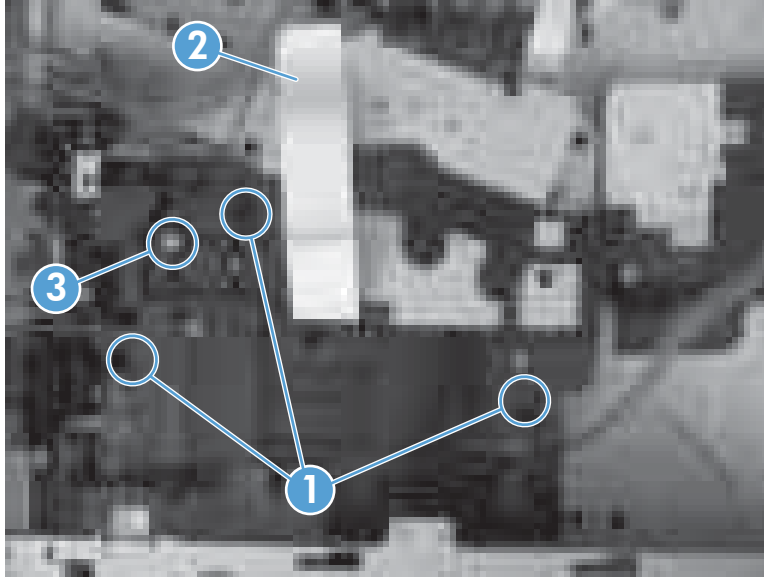
 **Reinstallation tip** Note the location of the FFC (callout 2) and the shaft (callout 3) for reinstallation.

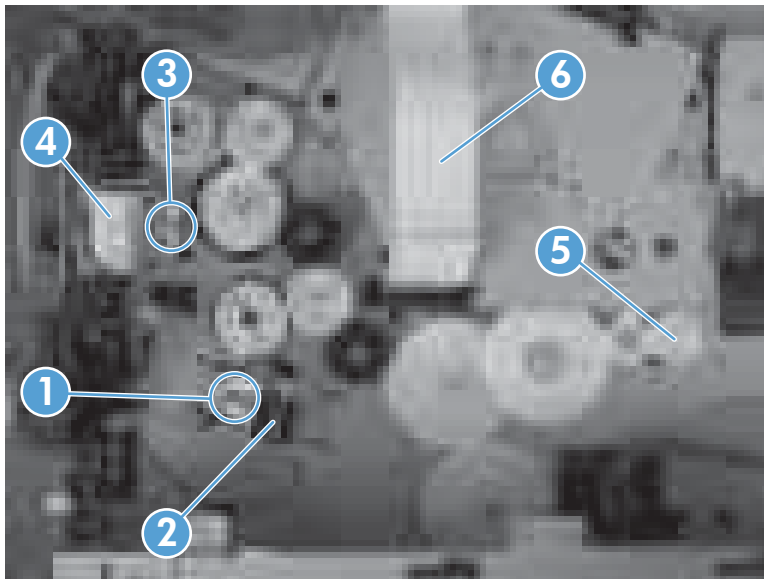
Figure 1-177 Remove the Tray 1 or Tray 2 pickup solenoid (2 of 3)




- For the Tray 2 pickup solenoid:** Remove one screw (callout 1), and then remove the solenoid (callout 2).

For the Tray 1 pickup solenoid: Remove one screw (callout 3), and then remove the solenoid (callout 4).

Figure 1-178 Remove the Tray 1 or Tray 2 pickup solenoid (3 of 3)



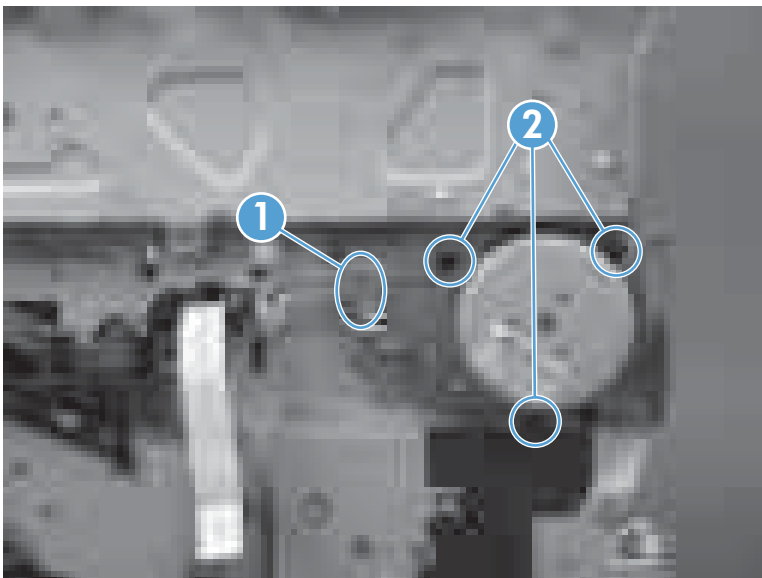
 **TIP:** Thread the FFC (callout 6) through the gear cover when reinstalling, and make sure to reinstall the gear (callout 5) if it becomes dislodged.

Fuser motor

⚠ WARNING!  ESD sensitive component.

1. Before proceeding, remove the following:
 - Formatter cover. See [Formatter cover on page 18](#).
 - Dummy cover. See [Dummy cover on page 23](#).
 - Formatter PCA. See [Formatter PCA on page 19](#).
 - Rear cover assembly. See [Rear cover assembly on page 24](#).
 - Left cover. See [Left cover on page 28](#).
 - Right-rear cover. See [Right-rear cover on page 30](#).
 - Tray 1 cover. See [Tray 1 cover on page 32](#).
 - Cartridge-door assembly. See [Cartridge-door assembly on page 34](#).
 - Right cover assembly. See [Right cover assembly on page 36](#).
 - Lower right cover. See [Lower right cover on page 41](#).
 - Document feeder/scanner assembly. See [Document feeder/scanner assembly on page 46](#).
 - Top cover. See [Top cover on page 95](#).
 - DC controller. See [DC controller on page 102](#).
 - Low-voltage power supply. See [Low-voltage power supply \(LVPS\) on page 106](#).
2. Disconnect one connector (callout 1), remove three screws (callout 2), and then remove the fuser motor.

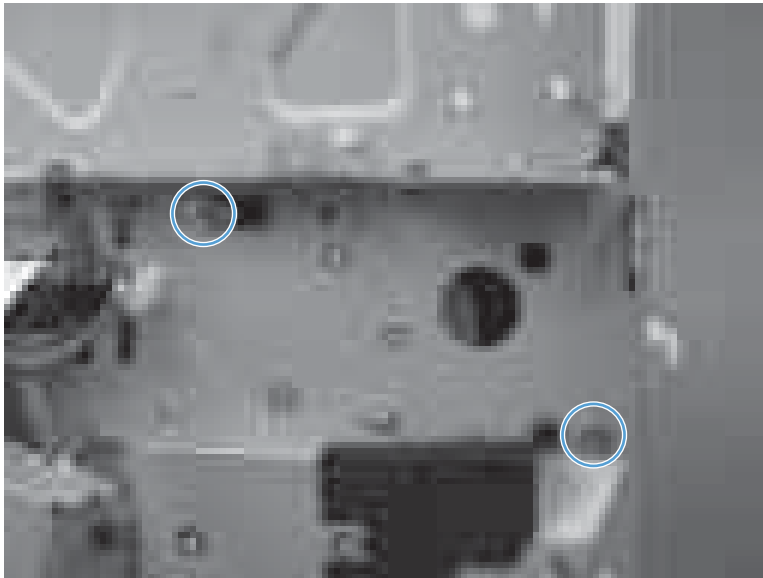
Figure 1-179 Remove the fuser motor



Pendulum assembly

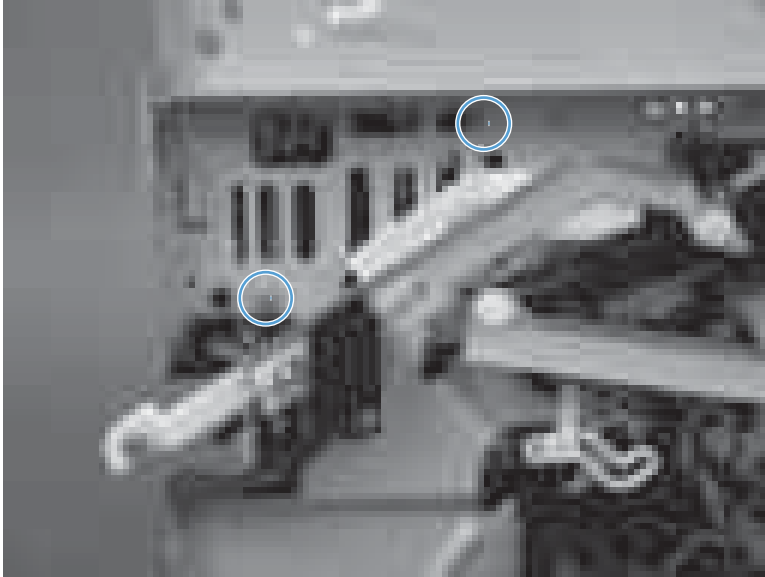
1. Before proceeding, remove the following:
 - Formatter cover. See [Formatter cover on page 18](#).
 - Dummy cover. See [Dummy cover on page 23](#).
 - Formatter PCA. See [Formatter PCA on page 19](#).
 - Rear cover assembly. See [Rear cover assembly on page 24](#).
 - Left cover. See [Left cover on page 28](#).
 - Right-rear cover. See [Right-rear cover on page 30](#).
 - Tray 1 cover. See [Tray 1 cover on page 32](#).
 - Cartridge-door assembly. See [Cartridge-door assembly on page 34](#).
 - Right cover assembly. See [Right cover assembly on page 36](#).
 - Lower right cover. See [Lower right cover on page 41](#).
 - Document feeder/scanner assembly. See [Document feeder/scanner assembly on page 46](#).
 - Top cover. See [Top cover on page 95](#).
 - DC controller. See [DC controller on page 102](#).
 - Low-voltage power supply. See [Low-voltage power supply \(LVPS\) on page 106](#).
 - Fuser motor. See [Fuser motor on page 120](#).
2. On the right side of the product, remove two screws.

Figure 1-180 Remove the pendulum assembly (1 of 4)



3. On the left side of the product, remove two screws.

Figure 1-181 Remove the pendulum assembly (2 of 4)



4. Release four wire harness holders from the chassis and then rotate the output bin roller assembly up to expose the pendulum assembly.


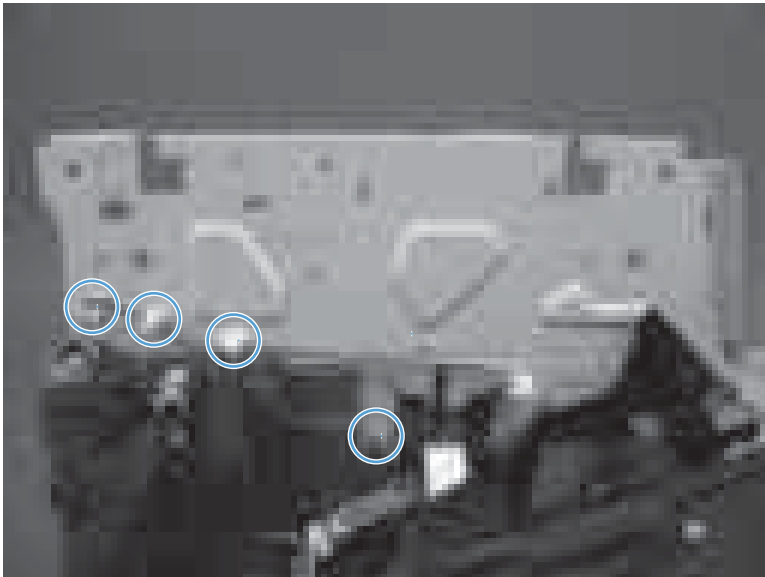
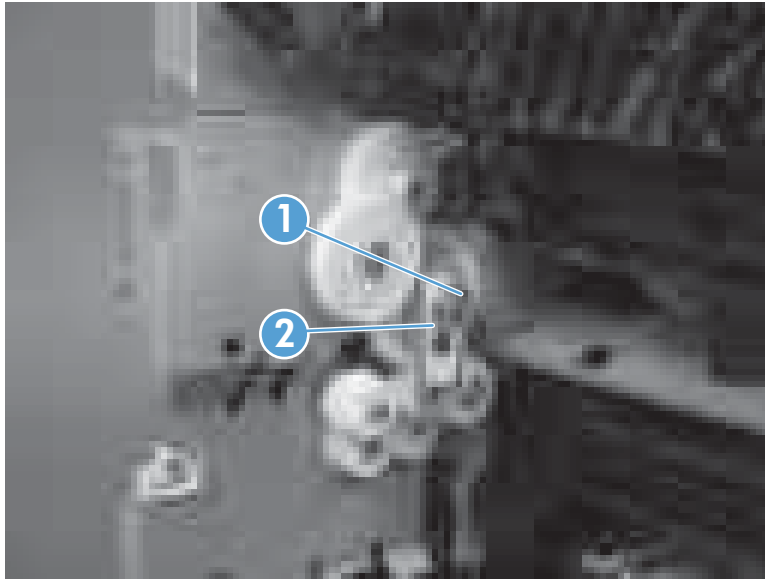
 **TIP:** Use needle-nose pliers to release the wire harness holders.

Figure 1-182 Remove the pendulum assembly (3 of 4)



5. Remove one e-clip (callout 1) and the assembly (callout 2).

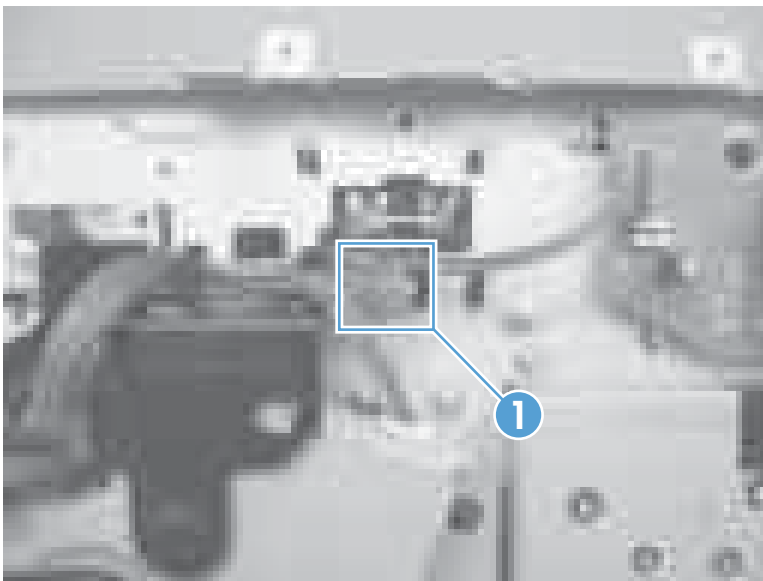
Figure 1-183 Remove the pendulum assembly (4 of 4)



Sub fan and fan duct

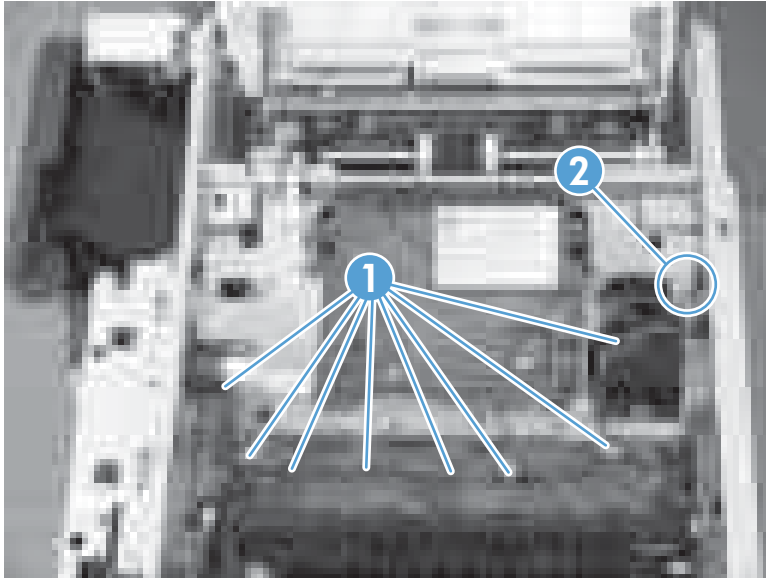
1. Before proceeding, remove the following:
 - Formatter cover. See [Formatter cover on page 18](#).
 - Dummy cover. See [Dummy cover on page 23](#).
 - Formatter PCA. See [Formatter PCA on page 19](#).
 - Rear cover assembly. See [Rear cover assembly on page 24](#).
 - Left cover. See [Left cover on page 28](#).
 - Right-rear cover. See [Right-rear cover on page 30](#).
 - Tray 1 cover. See [Tray 1 cover on page 32](#).
 - Cartridge-door assembly. See [Cartridge-door assembly on page 34](#).
 - Right cover assembly. See [Right cover assembly on page 36](#).
 - Lower right cover. See [Lower right cover on page 41](#).
 - Document feeder/scanner assembly. See [Document feeder/scanner assembly on page 46](#).
 - Top cover. See [Top cover on page 95](#).
 - DC controller. See [DC controller on page 102](#).
 - Low-voltage power supply. See [Low-voltage power supply \(LVPS\) on page 106](#).
2. Disconnect one connector (callout 1).

Figure 1-184 Remove the sub fan and fan duct (1 of 5)



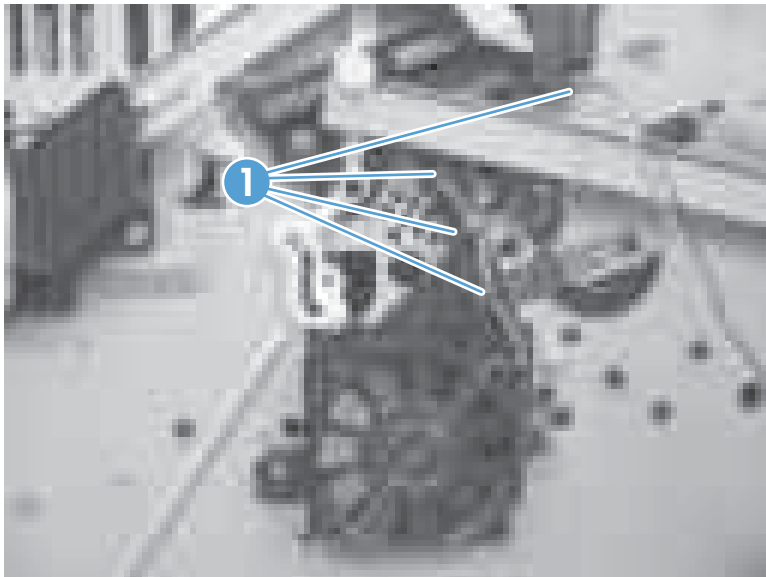
3. Release the wire harness from the retainers (callout 1), and then feed the wire harness through the opening in the chassis (callout 2).

Figure 1-185 Remove the sub fan and fan duct (2 of 5)



4. Release the wire harness from the retainers (callout 1).

Figure 1-186 Remove the sub fan and fan duct (3 of 5)



5. **To remove the fan and duct:** Remove two screws (callout 1), and then carefully remove the fan and duct.


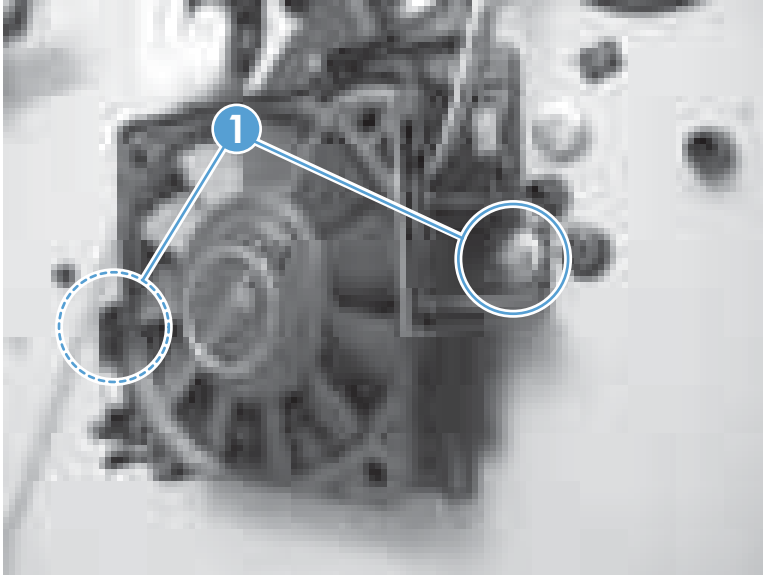
 **NOTE:** If necessary, release the metal static clip, release two tabs and separate the fan from the duct.

Figure 1-187 Remove the sub fan and fan duct (4 of 5)



6. **To remove the fan only:** Release the metal static clip, release two tabs (callout 1), and then remove the sub fan.


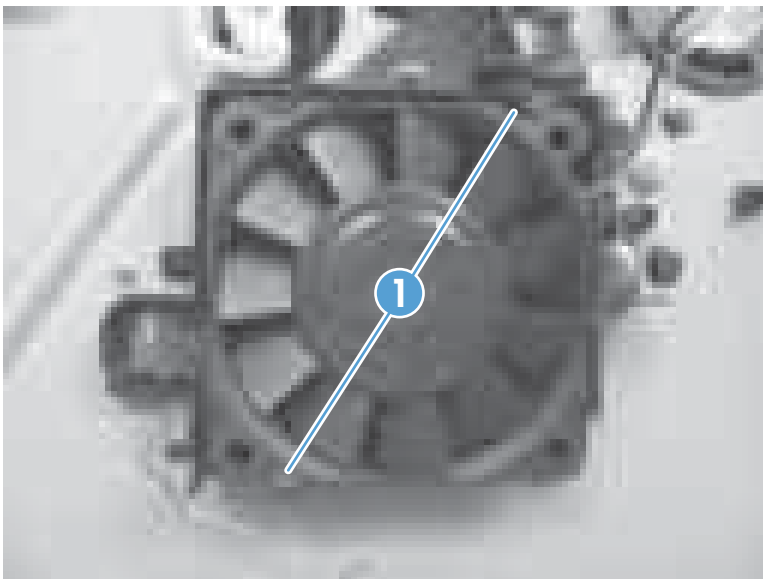
 **Reinstallation tip** If you install a replacement sub fan, the air must flow into the product. Arrows embossed on the fan frame indicate air flow direction.

Figure 1-188 Remove the sub fan and fan duct (5 of 5)



Reinstall the sub fan

- ▲ Make sure to correctly reinstall the metal static clip.

Figure 1-189 Reinstall the sub fan (1 of 2)

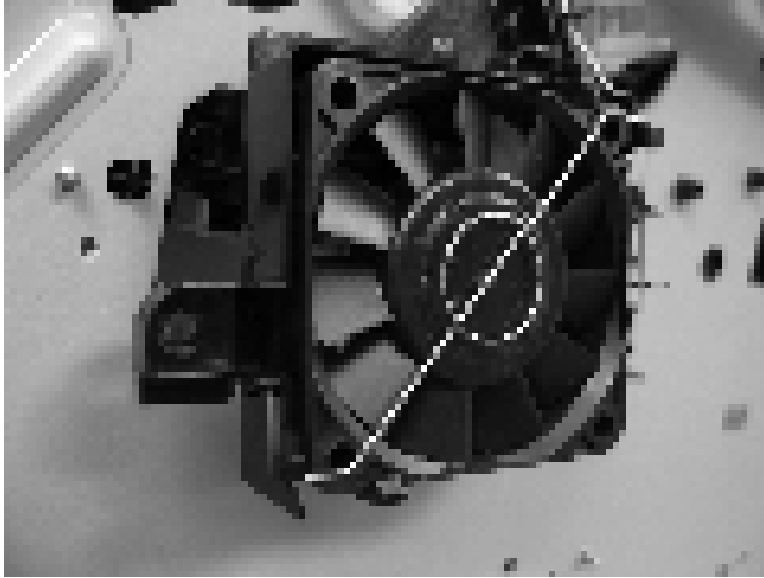
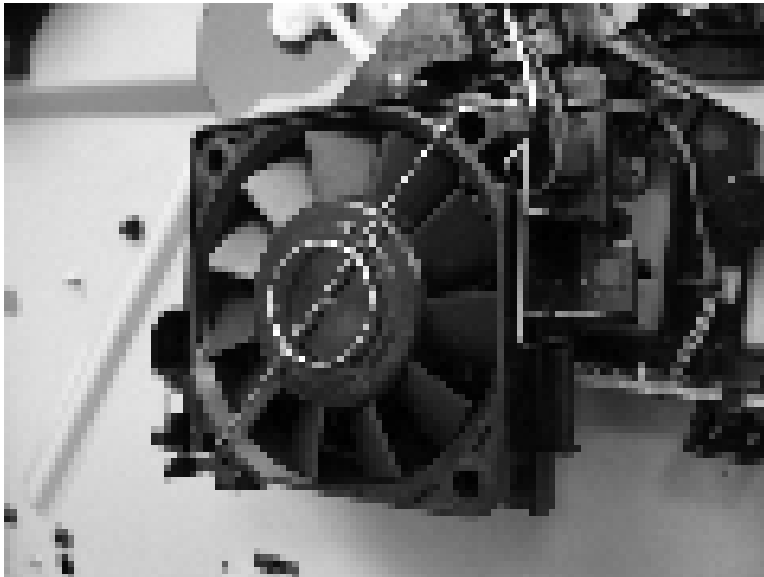


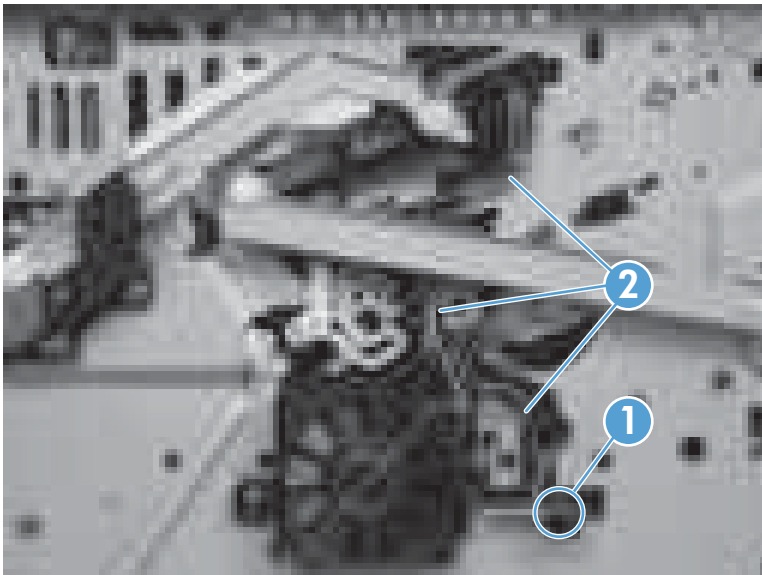
Figure 1-190 Reinstall the sub fan (2 of 2)



Environmental sensor

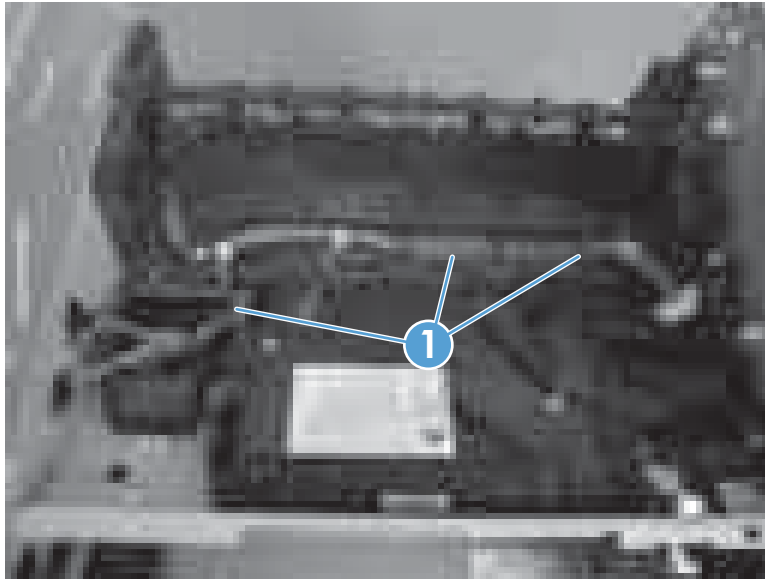
1. Before proceeding, remove the following:
 - Formatter cover. See [Formatter cover on page 18](#).
 - Dummy cover. See [Dummy cover on page 23](#).
 - Formatter PCA. See [Formatter PCA on page 19](#).
 - Rear cover assembly. See [Rear cover assembly on page 24](#).
 - Left cover. See [Left cover on page 28](#).
 - Right-rear cover. See [Right-rear cover on page 30](#).
 - Tray 1 cover. See [Tray 1 cover on page 32](#).
 - Cartridge-door assembly. See [Cartridge-door assembly on page 34](#).
 - Right cover assembly. See [Right cover assembly on page 36](#).
 - Lower right cover. See [Lower right cover on page 41](#).
 - Document feeder/scanner assembly. See [Document feeder/scanner assembly on page 46](#).
 - Top cover. See [Top cover on page 95](#).
 - DC controller and sheet-metal plate. See [DC controller on page 102](#).
 - Low-voltage power supply. See [Low-voltage power supply \(LVPS\) on page 106](#).
2. Release one tab (callout 1), and then release the sensor. Release the wire harness (callout 2) from the retainers.

Figure 1-191 Remove the environmental sensor (1 of 2)



3. Release the wire harness from the retainers (callout 1), and then remove the sensor.

Figure 1-192 Remove the environmental sensor (2 of 2)



High-voltage power supply (HVPS)

1. Before proceeding, remove the following:
 - Formatter cover. See [Formatter cover on page 18](#).
 - Dummy cover. See [Dummy cover on page 23](#).
 - Formatter PCA. See [Formatter PCA on page 19](#).
 - Rear cover assembly. See [Rear cover assembly on page 24](#).
 - Left cover. See [Left cover on page 28](#).
 - Right-rear cover. See [Right-rear cover on page 30](#).
 - Tray 1 cover. See [Tray 1 cover on page 32](#).
 - Cartridge-door assembly. See [Cartridge-door assembly on page 34](#).
 - Right cover assembly. See [Right cover assembly on page 36](#).
 - Lower right cover. See [Lower right cover on page 41](#).
 - Document feeder/scanner assembly. See [Document feeder/scanner assembly on page 46](#).
 - Duplex paper-feed assembly. See [Duplex paper-feed assembly on page 83](#).
 - Top cover. See [Top cover on page 95](#).
 - DC controller and sheet-metal plate. See [DC controller on page 102](#).
 - Low-voltage power supply. See [Low-voltage power supply \(LVPS\) on page 106](#).

2. Place the product on its side with the gear cover facing up. Remove one screw (callout 1).


 **NOTE:** In this figure the gear cover is shown removed for clarity. Do not remove the gear cover. The gears behind the cover are not captive and can easily be dislodged if the cover is removed.

Figure 1-193 Remove the HVPS (1 of 12)



3. Place the product on its rear side. Remove one screw, and then remove the base-plate (callout 2).


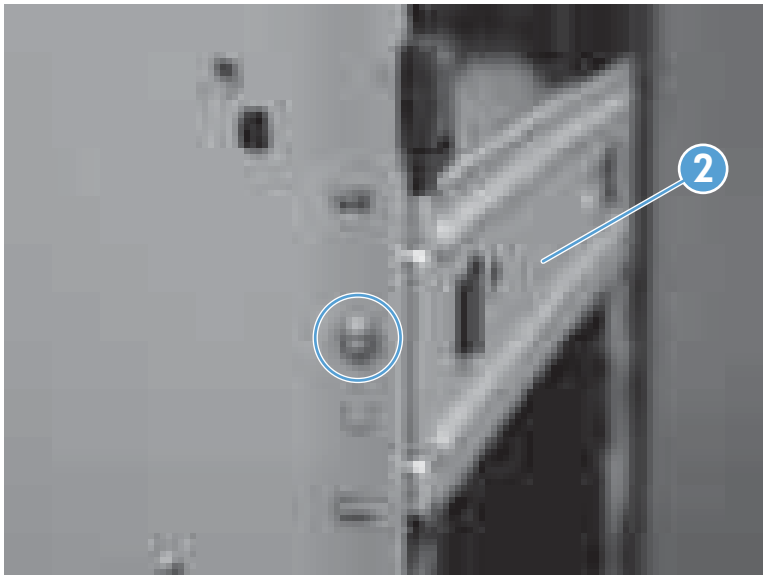
 **Reinstallation tip** Be sure to correctly align the base-plate. It should match the base-plate at the rear of the product.

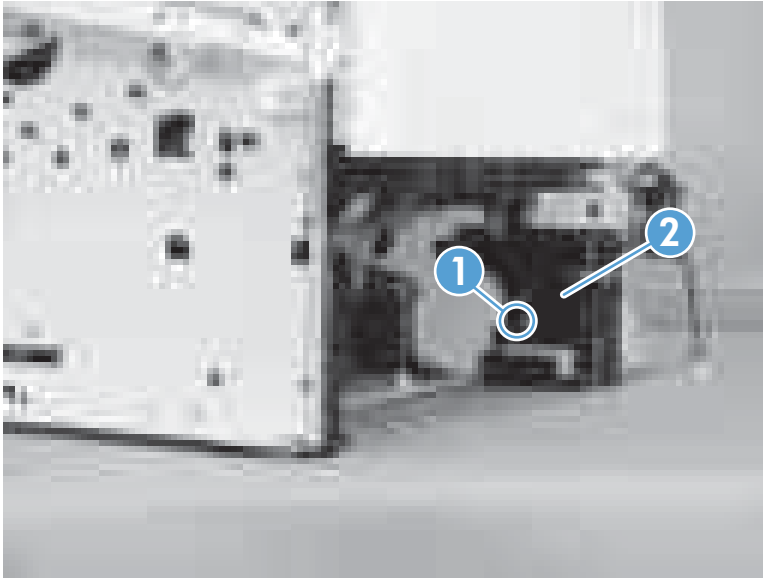
Figure 1-194 Remove the HVPS (2 of 12)



4. Remove one screw (callout 1), and then remove the right-side guide (callout 2).

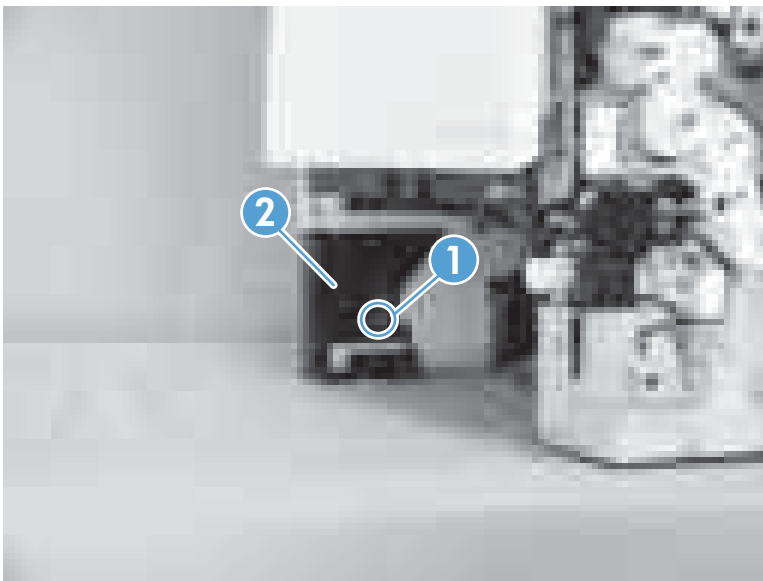
⚠ CAUTION: Use the caution. The solenoid is still attached.

Figure 1-195 Remove the HVPS (3 of 12)



5. Remove one screw (callout 1), and then remove the left-side guide (callout 2).

Figure 1-196 Remove the HVPS (4 of 12)



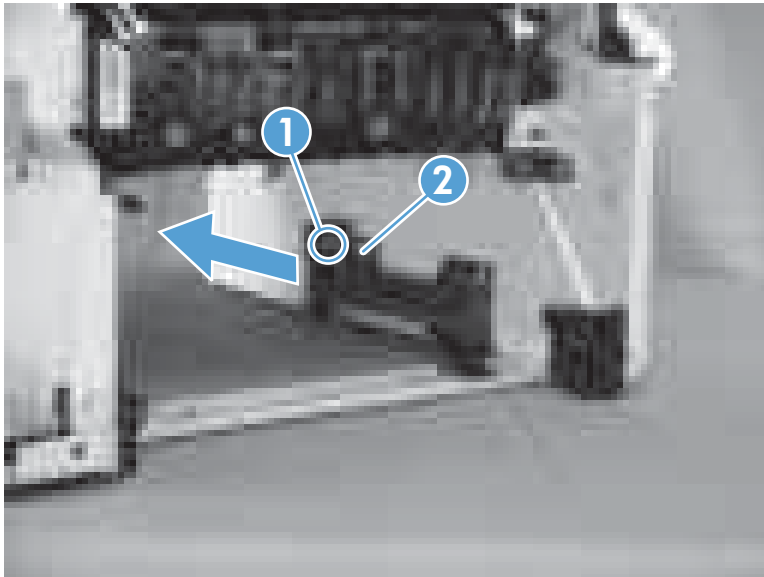
6. Disconnect one connector.

Figure 1-197 Remove the HVPS (5 of 12)



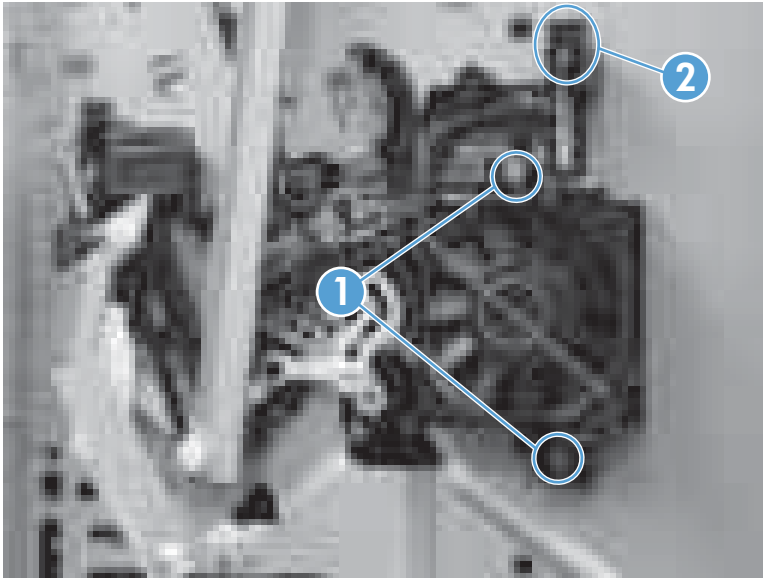
7. Remove one screw (callout 1), release one tab (callout 2), and then slide the guide toward the front of the product to release it.

Figure 1-198 Remove the HVPS (6 of 12)



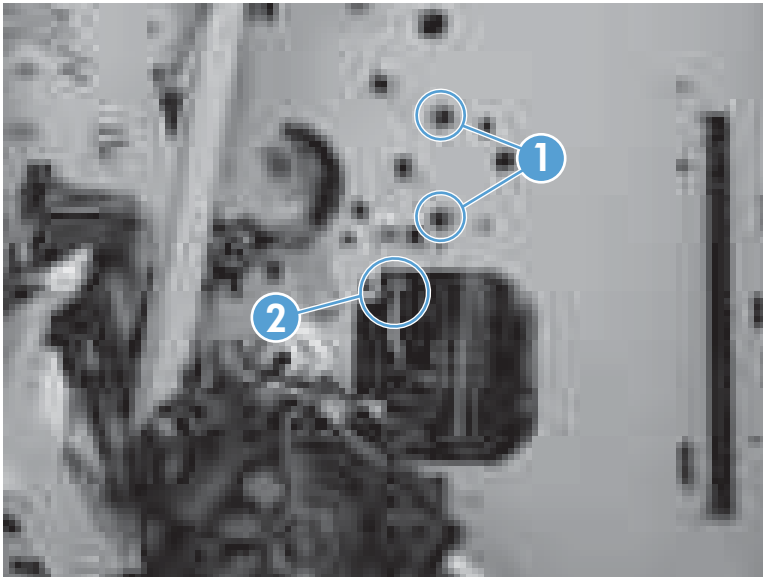
8. Remove two screws (callout 1), and then release one tab (callout 2). Let the sub fan and environmental sensor hang from their wire harnesses.

Figure 1-199 Remove the HVPS (7 of 12)



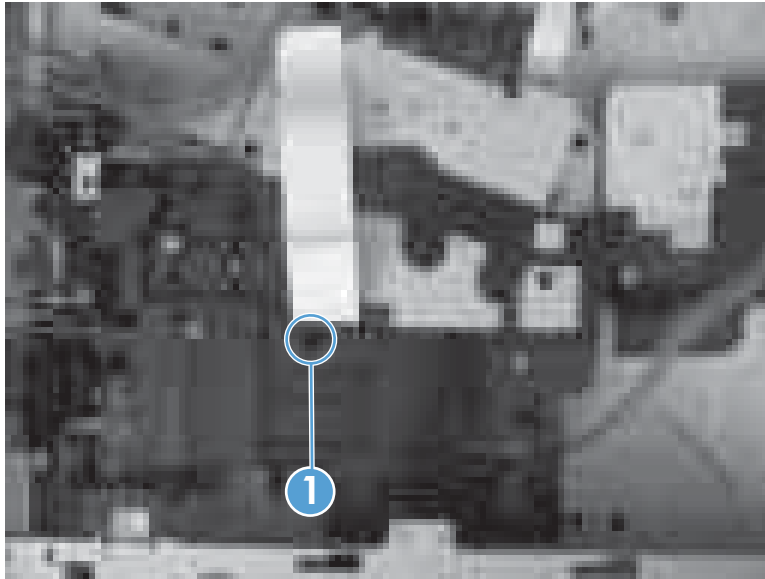
9. Remove two screws (callout 1), and then disconnect one connector (callout 2).

Figure 1-200 Remove the HVPS (8 of 12)



10. Remove one screw (callout 1).

Figure 1-201 Remove the HVPS (9 of 12)

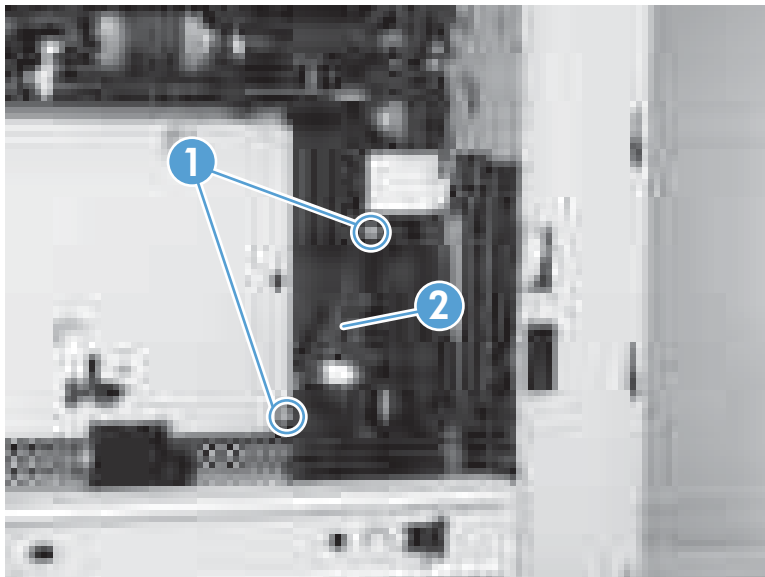


11. Place the product face-side up. Remove two screws (callout 1), and then remove the positioning guide (callout 2).

⚠ CAUTION: When you place the product face-side up, do not damage the rear-door link arm on the left side of the product.

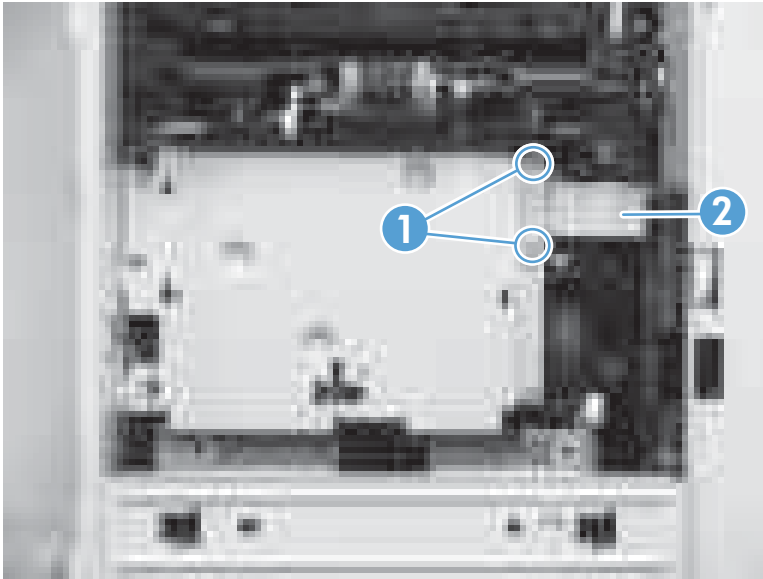
📝 NOTE: The positioning guide might appear to still be fastened to the product. You might have to use slight force to separate it from the product.

Figure 1-202 Remove the HVPS (10 of 12)



12. Remove two screws (callout 1), and then remove the plate (callout 2).

Figure 1-203 Remove the HVPS (11 of 12)



13. Remove three screws (callout 1), and then remove the HVPS (callout 2).


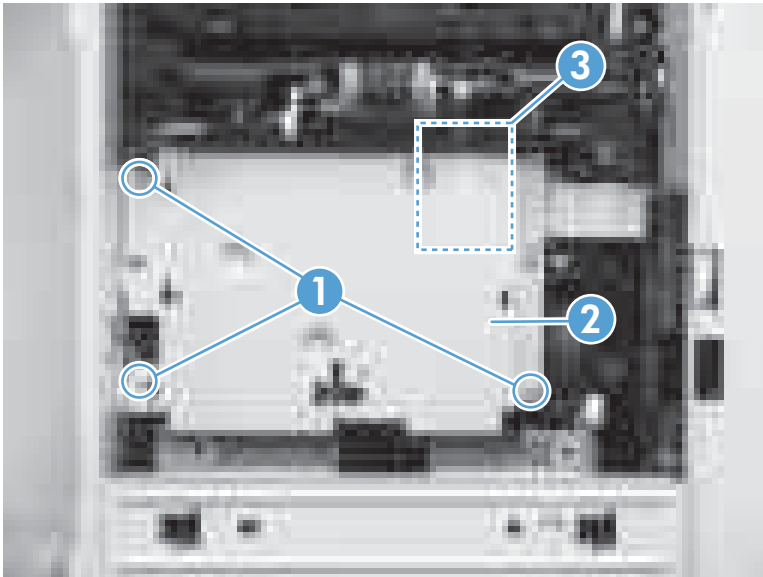
 **NOTE:** Disconnect three connectors and one FFC (callout 3) on the HPVS as you separate the it from the product.

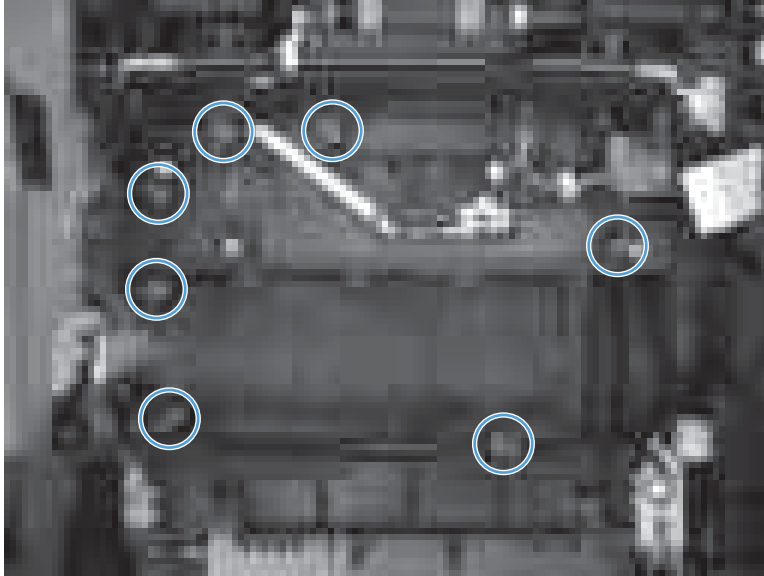
Figure 1-204 Remove the HVPS (12 of 12)



Reinstall the HVPS

- ▲ Make sure the HVPS is installed as straight as possible and that it aligns correctly with the grounding springs.

Figure 1-205 Reinstall the HVPS



2 Parts and diagrams

- [Order parts by authorized service providers](#)
- [Related documentation and software](#)
- [Fasteners used in this product](#)
- [How to use the parts lists and diagrams](#)
- [Assembly locations](#)
- [Covers](#)
- [Document feeder and scanner assemblies](#)
- [Control-panel and USB PCA assemblies](#)
- [Document feeder assemblies](#)
- [Internal assemblies \(1 of 6\)](#)
- [Internal assemblies \(2 of 6\)](#)
- [Internal assemblies \(3 of 6\)](#)
- [Internal assemblies \(4 of 6\)](#)
- [Internal assemblies \(5 of 6\)](#)
- [Internal assemblies \(6 of 6\)](#)
- [Input devices](#)
- [Alphabetical parts list](#)
- [Numerical parts list](#)

Order parts by authorized service providers

Order parts, accessories, and supplies

Table 2-1 Order parts, accessories, and supplies

Order supplies and paper	www.hp.com/go/suresupply
Order genuine HP parts or accessories	www.hp.com/buy/parts
Order through service or support providers	Contact an HP-authorized service or support provider.
Order using HP software	For information about using the HP software to order parts, accessories, and supplies, see the product user guide.
Power cables	8121-0564; India 220 v, 6A 8121-0729; Argentina 220 v, 10A 8121-0731; Korea, EU generic 220 v, 10A 8121-0733; Denmark 220 v, 10A 8121-0734; Thailand, Philippines 220/110 v 8121-0735; South America, Chile, Peru 220 v, 10A 8121-0737; South Africa 220 v, 10A 8121-0738; Switzerland 220 v, 10A 8121-0739; UK, Asia Pacific 220 v, 10A 8121-0740; North America 110 v, 13A 8121-0837; Australia, New Zealand 220 v, 10A 8121-0943; China 220 v, 10A 8121-0964; Taiwan 110 v, 13A 8121-1004; Israel 220 v, 10A 8121-1071; Brazil 110 v, 10A

Supplies part numbers

Table 2-2 Supplies part numbers

Item	Description	Part number
HP LaserJet toner cartridge	Standard-capacity cartridge	CE255-67901
	High-capacity cartridge	CE255-67902

Customer self-repair (CSR) and service kits

Table 2-3 Customer self-repair (CSR) and service kits

Item	Part number
Tray 1 cover kit; includes name plate & HP logo	A8P80-65010
Complete 500-sheet feeder for Tray 3; includes cassette	CE530-69001
ADF whole unit kit	A8P79-65014
Scanner (flatbed) whole unit kit	A8P79-65015
ADF roller maintenance kit	A8P79-65001
ADF separation pad maintenance kit	A8P79-65010
Fax two ports relevant kit	A8P79-65019
Service PM kit	CF116-67903

Related documentation and software

Table 2-4 Related documentation and software

Item	Description	Part number
<i>HP LaserJet Pro MFP M521 Printer Printer User Guide</i>	Product user guide	A8P80-90908
<i>HP LaserJet Pro MFP M521 Printer Repair Manual</i>	English service repair manual	A8P79-90904
<i>HP LaserJet Pro MFP M521 Printer Troubleshooting Manual</i>	English service troubleshooting manual	A8P79-90906

Fasteners used in this product


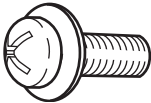
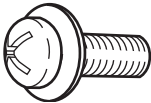
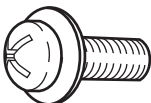
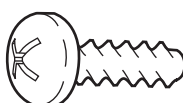
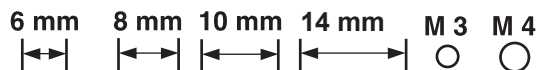
 **NOTE:** The screw illustrations in the following table are for reference only. Screws might vary in size and appearance from those shown in this table.

Illustration	Description	Size	Part number	Use
	Screw	M3X6	0515-2908	Used to secure metal components to metal components (for example, a ground wire to the frame)
	Screw	M3X8	0515-4681	
	Screw, tapping	P-M3X6	0515-5621	
	Screw, tapping, truss head	M4X14	0515-4672	Used to secure anything to plastic



How to use the parts lists and diagrams

⚠ CAUTION: Be sure to order the correct part. When looking for part numbers for electrical components, pay careful attention to the voltage that is listed. Doing so will make sure that the part number selected is for the correct model.

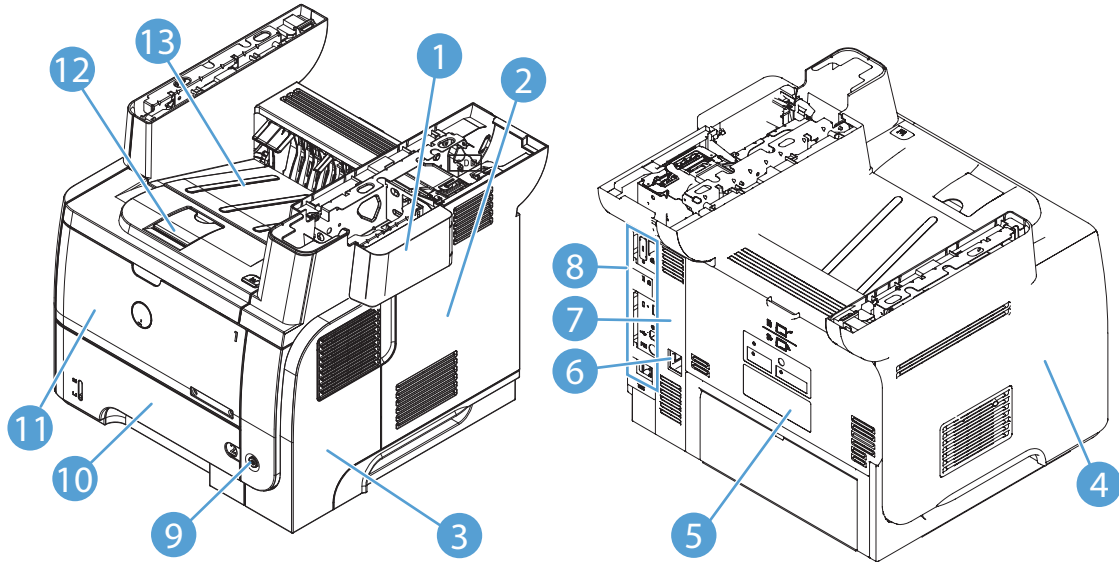
📝 NOTE: In this manual, the abbreviation “PCA” stands for “printed circuit-board assembly.” Components described as a PCA might consist of a single circuit board or a circuit board plus other parts, such as cables and sensors.

The figures in this chapter show the major subassemblies in the product and their component parts. A parts list table follows each exploded view assembly diagram. Each table lists the item number, the associated part number, and the description of each part. If a part is not listed in the table, then it is not a field replacement unit (FRU).

Assembly locations

Base product (no optional trays or accessories)

Figure 2-1 Base product (no optional trays or accessories)



Item	Description	Item	Description
1	Dummy cover	8	I/O plate
2	Formatter cover	9	Power switch
3	Right cover	10	Tray 2
4	Left cover	11	Tray 1/Cartridge drawer door
5	Rear door	12	Output-bin extension for long paper
6	Power port	13	Standard output bin
7	Right-rear cover		

Base product (optional trays or accessories)

Figure 2-2 Base product (optional trays or accessories)

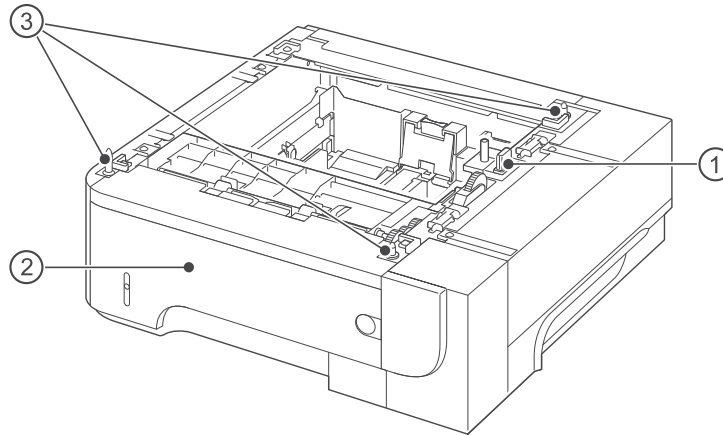


Table 2-5 Optional 500-sheet input tray

Item	Description
1	Connector
2	Tray 2 or Tray 3
3	Positioning pin

Covers

Figure 2-3 Covers

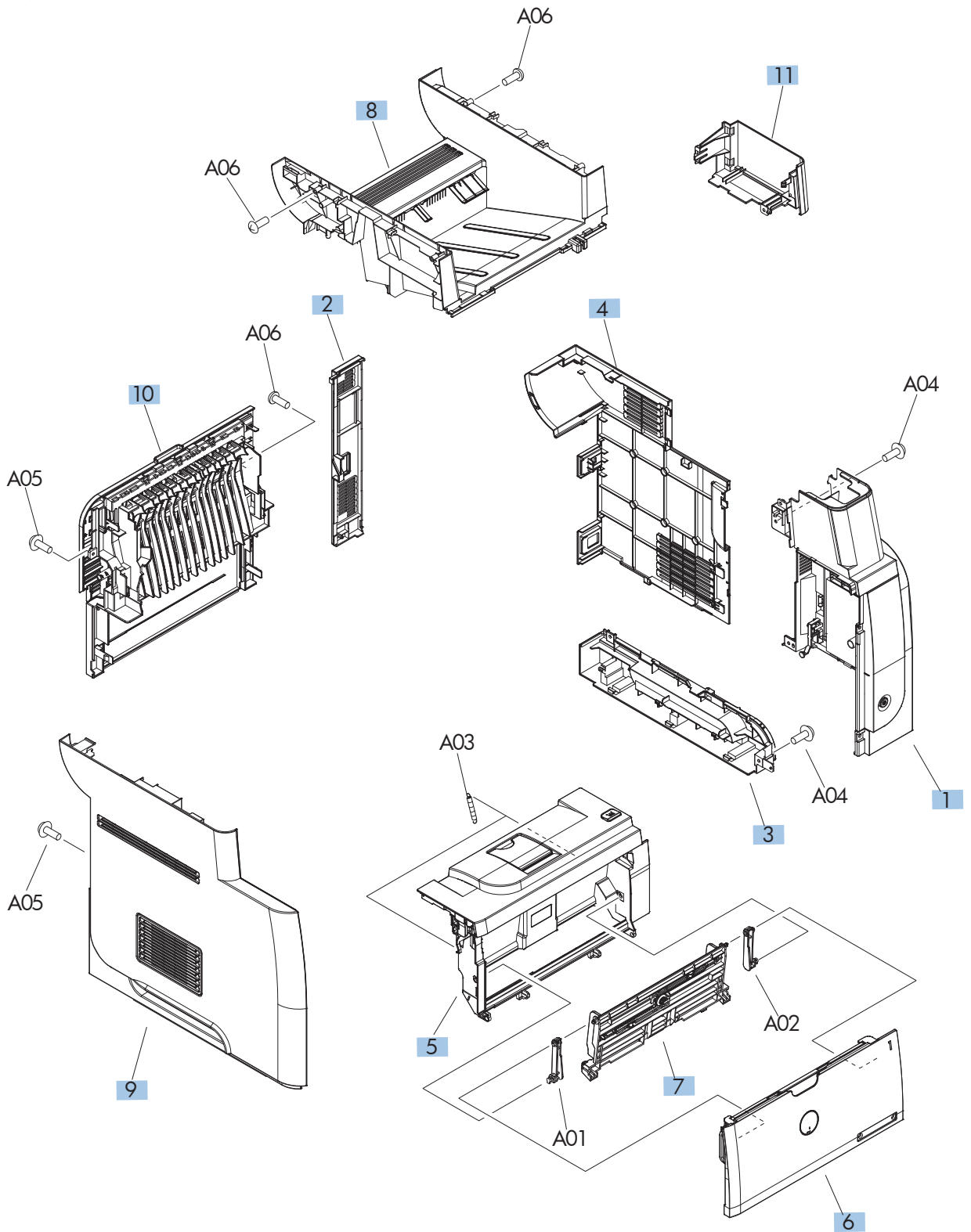


Table 2-6 Covers

Ref	Description	Part number	Qty
1	Cover, right assembly	RM1-8498-000CN	1
2	Cover, right rear	RC2-7673-000CN	1
3	Cover, handle, right	RC2-7675-000CN	1
4	Cover, formatter	RC3-1863-010CN	1
5	Door, cartridge assembly	RM1-8502-000CN	1
6	Cover kit, Tray 1	A8P80-65010	1
7	Multipurpose lifting plate assembly	RM1-6325-000CN	1
8	Cover, top assembly	RM1-8516-000CN	1
9	Cover, left assembly	RM1-8517-000CN	1
10	Cover, rear assembly	RM1-8518-000CN	1
11	Cover, dummy	RC3-1920-000CN	1

Document feeder and scanner assemblies

Figure 2-4 Document feeder and scanner assemblies

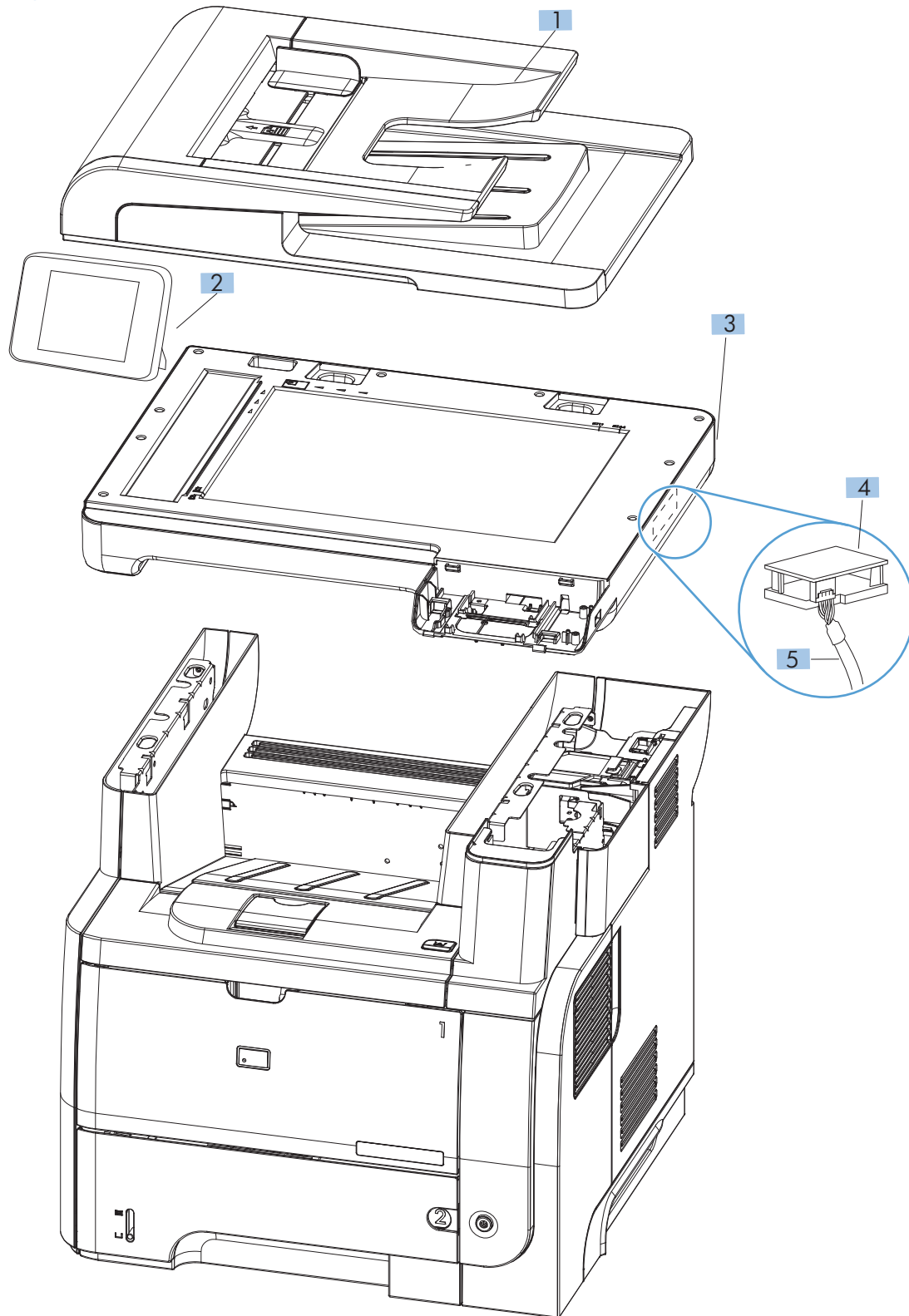


Table 2-7 Document feeder and scanner assemblies

Ref	Description	Part number	Qty
1	ADF assembly	A8P79-60120	1
2	Control-panel assembly	A8P79-60115	1
3	Scanner assembly	A8P79-60121	1
4	Wi-Fi module	1150-7957	1
5	Wi-Fi cable	A8P80-60101	1

Control-panel and USB PCA assemblies

Figure 2-5 Control-panel assembly

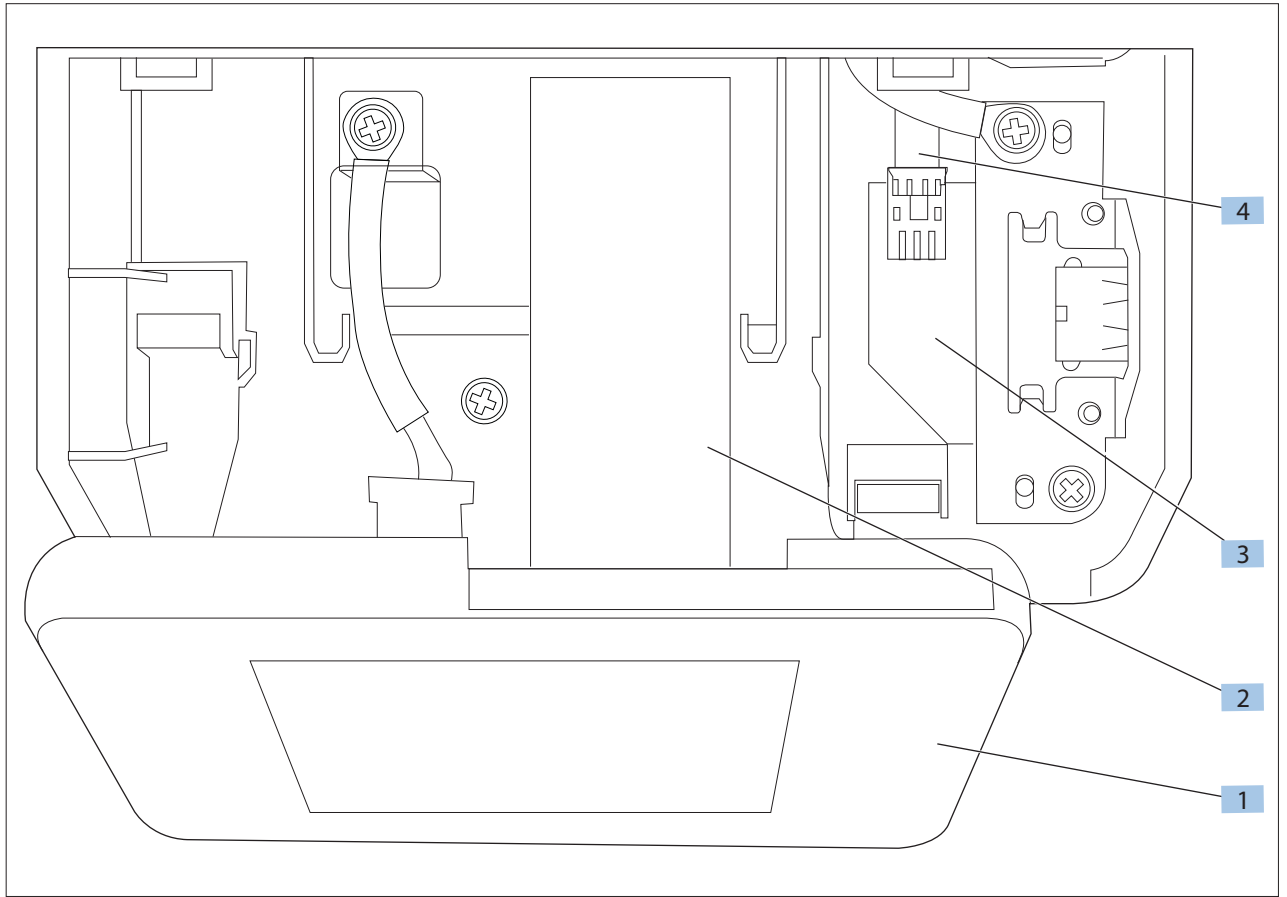


Table 2-8 Control-panel assembly

Ref	Description	Part number	Qty
1	Control-panel assembly	A8P79-60115	1
2	Control-panel FFC	A8P79-60106	1
3	USB PCA	CF368-60001	1
4	USB cable	A8P79-60102	1

Document feeder assemblies

Figure 2-6 Document feeder assemblies

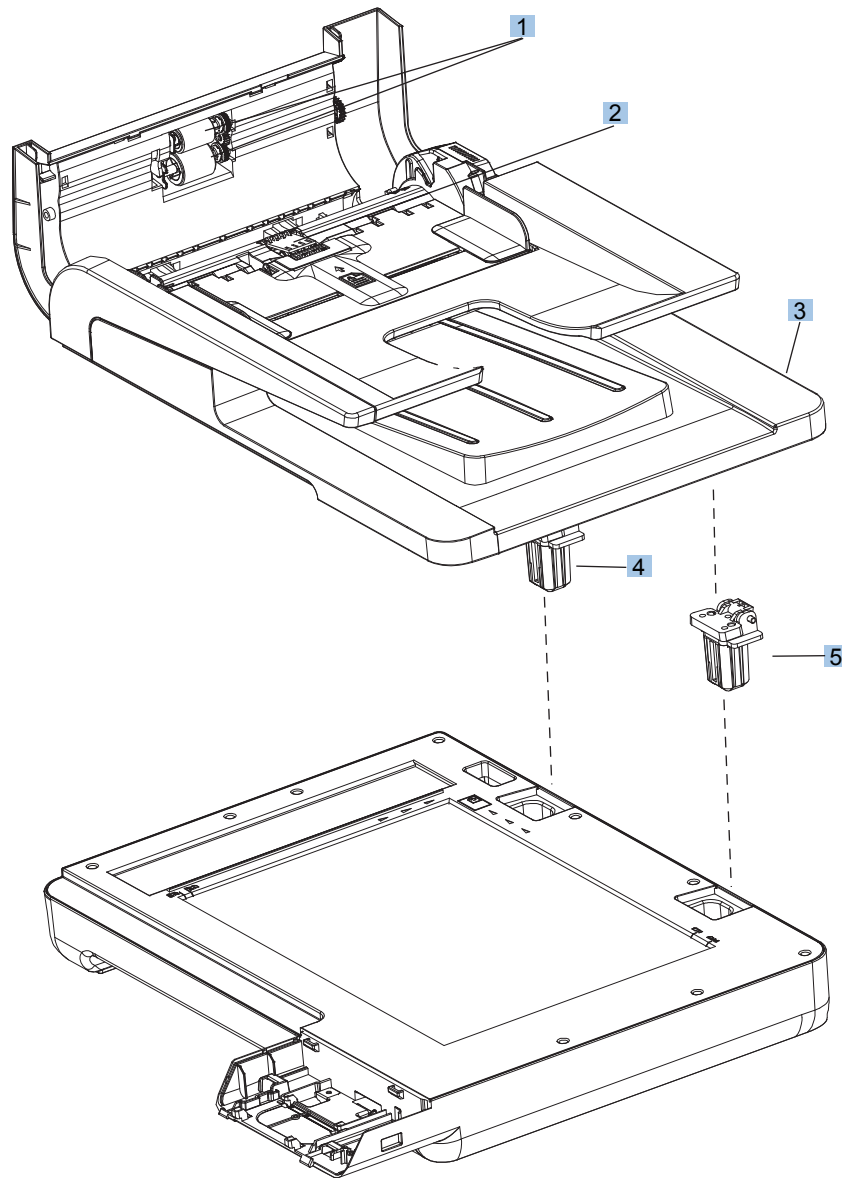


Table 2-9 Document feeder assemblies

Ref	Description	Part number	Qty
1	ADF roller maintenance kit	A8P79-65001	1
2	ADF separation pad maintenance kit	A8P79-65010	1
3	ADF assembly	A8P79-60120	1
4	ADF hinge assembly, left	CZ271-60020	1
5	ADF hinge assembly, right	A8P79-60011	1
Not shown	ADF whole unit kit	A8P79-65014	1

Internal assemblies (1 of 6)

Figure 2-7 Internal assemblies (1 of 6)

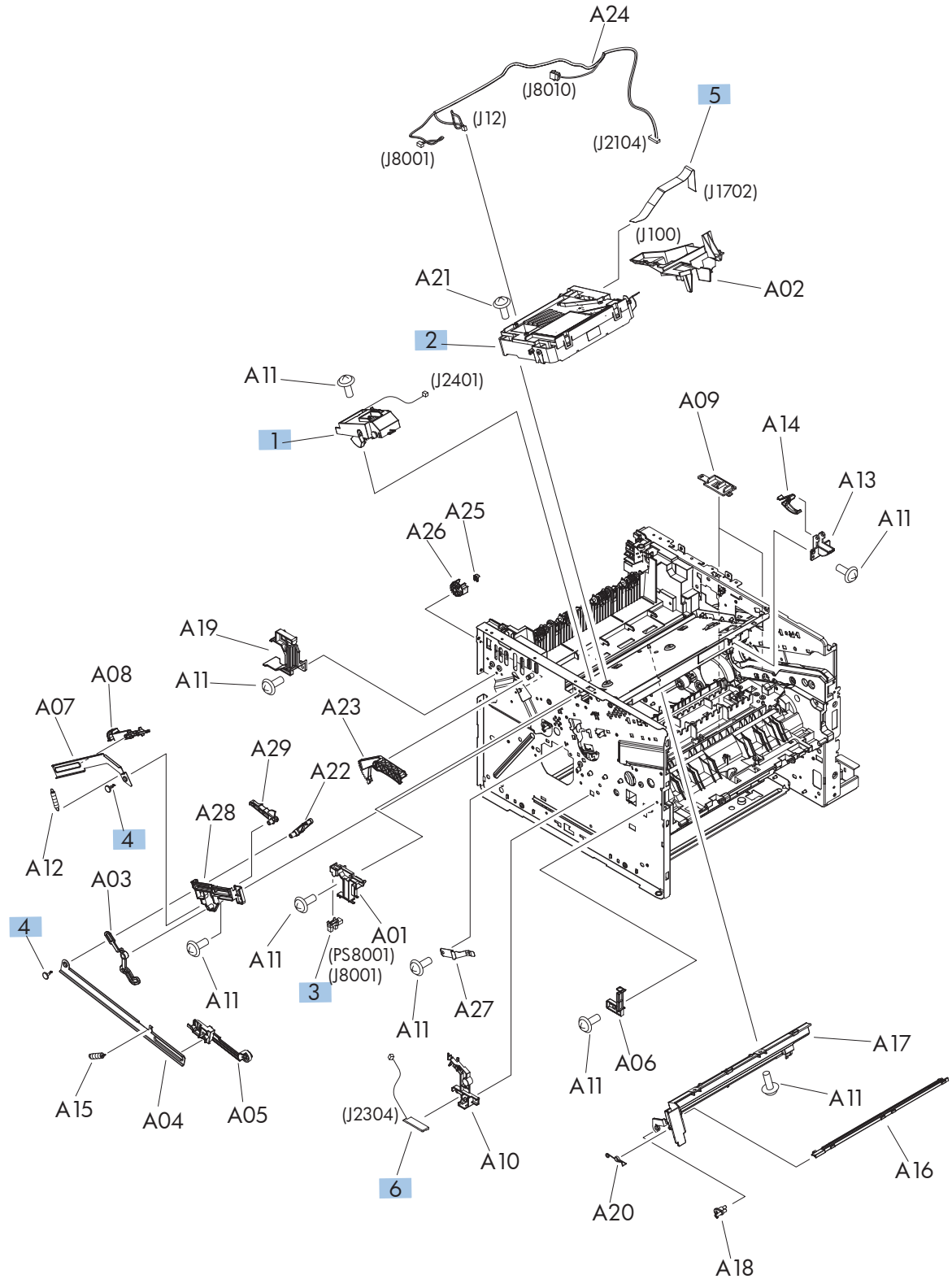


Table 2-10 Internal assemblies (1 of 6)

Ref	Description	Part number	Qty
1	Tag holder assembly	RM1-8521-000CN	1
2	Laser/scanner	RM1-6322-000CN	1
3	Photo interrupter, IC	WG8-5935-000CN	1
4	Stopper, bushing arm	RC2-7928-000CN	2
5	Cable, flat	RK2-4218-000CN	1
6	Sensor, environmental PCA	RM1-8622-000CN	1

Internal assemblies (2 of 6)

Figure 2-8 Internal assemblies (2 of 6)

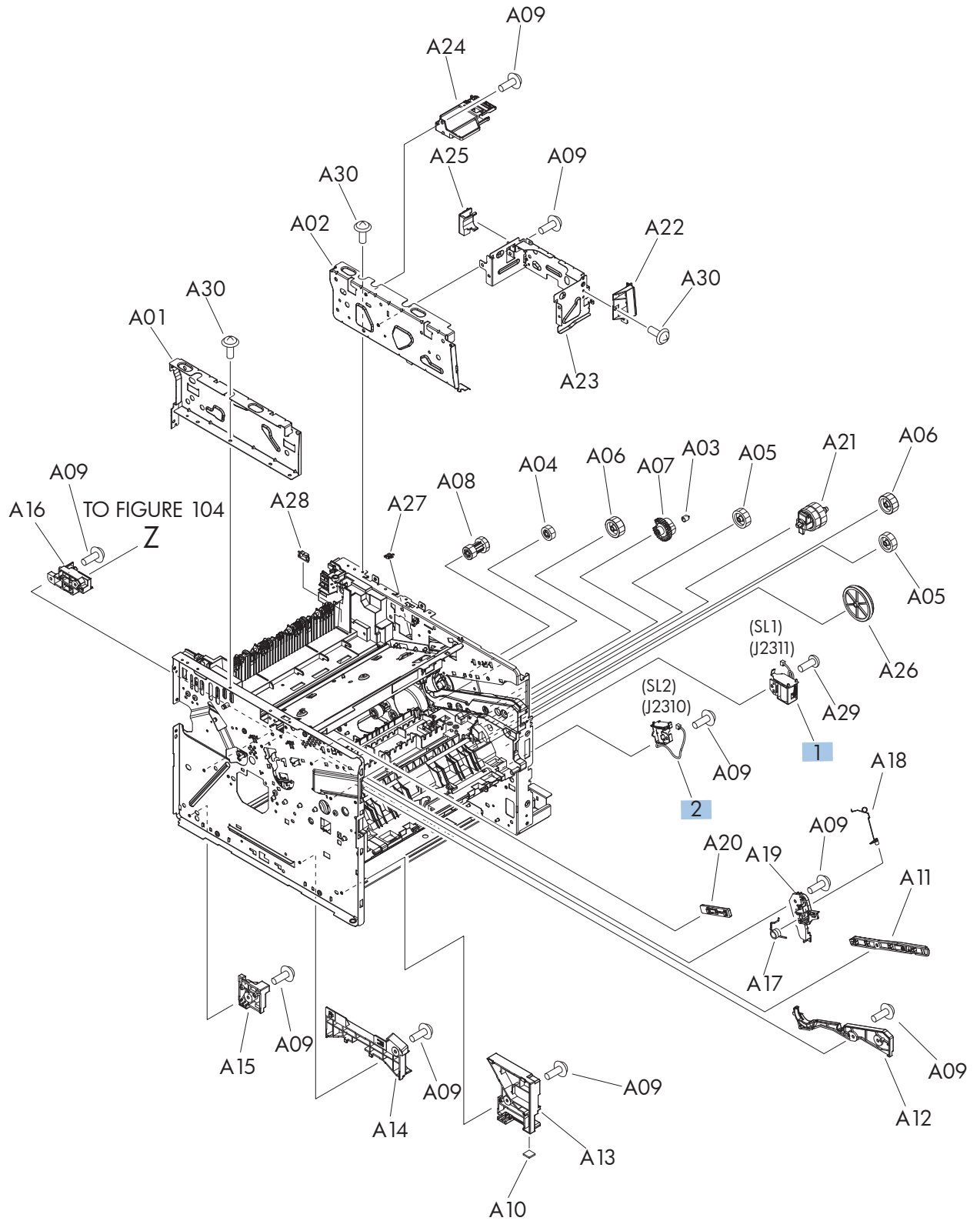


Table 2-11 Internal assemblies (2 of 6)

Ref	Description	Part number	Qty
1	Tray 1 solenoid	RK2-1490-000CN	1
2	Tray 2 solenoid	RK2-1492-000CN	1

Internal assemblies (3 of 6)

Figure 2-9 Internal assemblies (3 of 6)

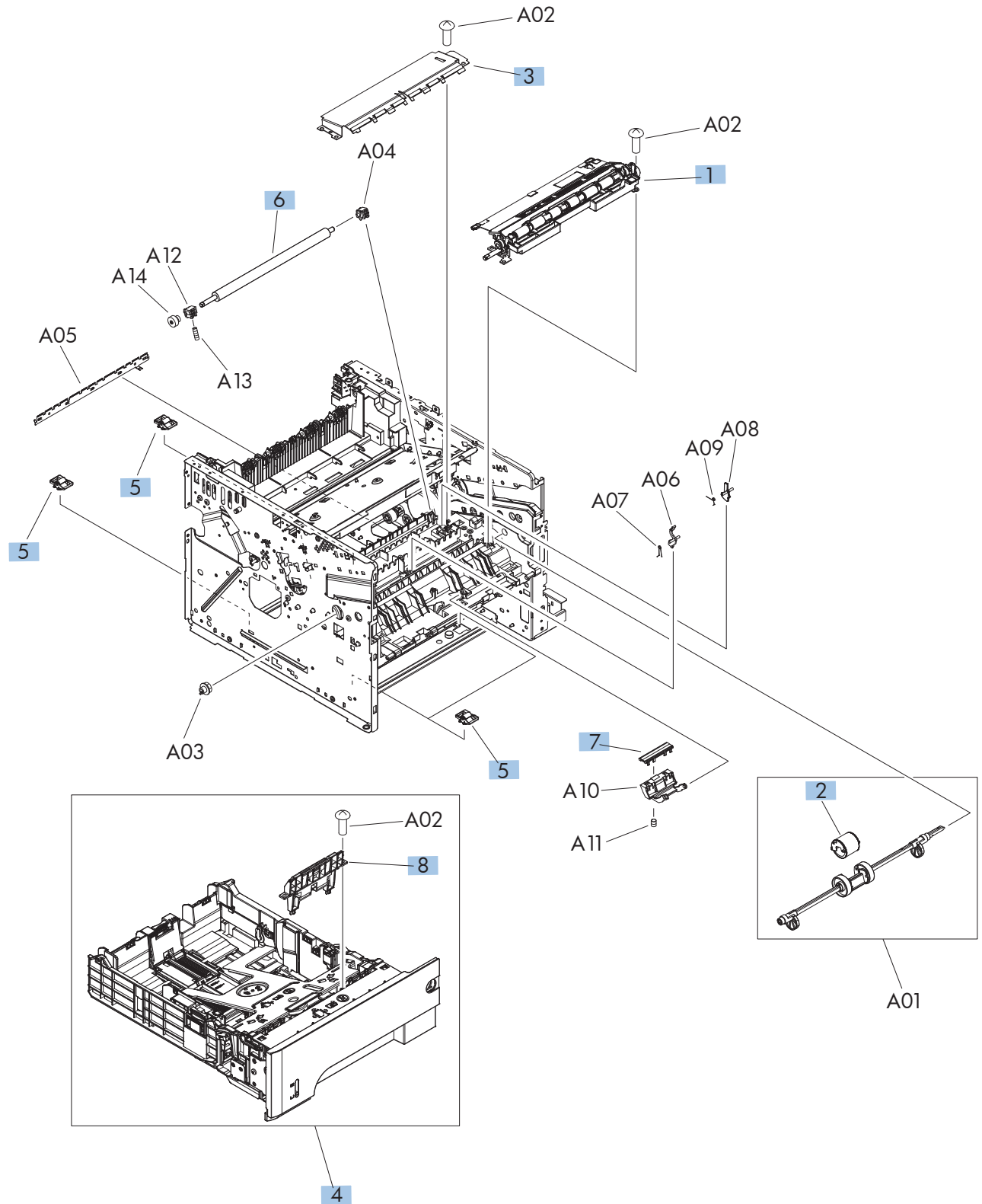


Table 2-12 Internal assemblies (3 of 6)

Ref	Description	Part number	Qty
1	Registration roller assembly	RM1-8507-000CN	1
2	Roller, multipurpose	RL1-2412-000CN	1
3	Transfer lower guide assembly	RM1-6315-000CN	1
4	Cassette, Tray 2	RM1-8512-000CN	1
5	Base-plate roller assembly	RM1-6306-000CN	4
6	Roller, transfer	RM1-6321-000CN	1
7	Pad, multipurpose separation	RC2-8575-000CN	1
8	Separation holder assembly	RM1-6303-000CN	1

Internal assemblies (4 of 6)

Figure 2-10 Internal assemblies (4 of 6)

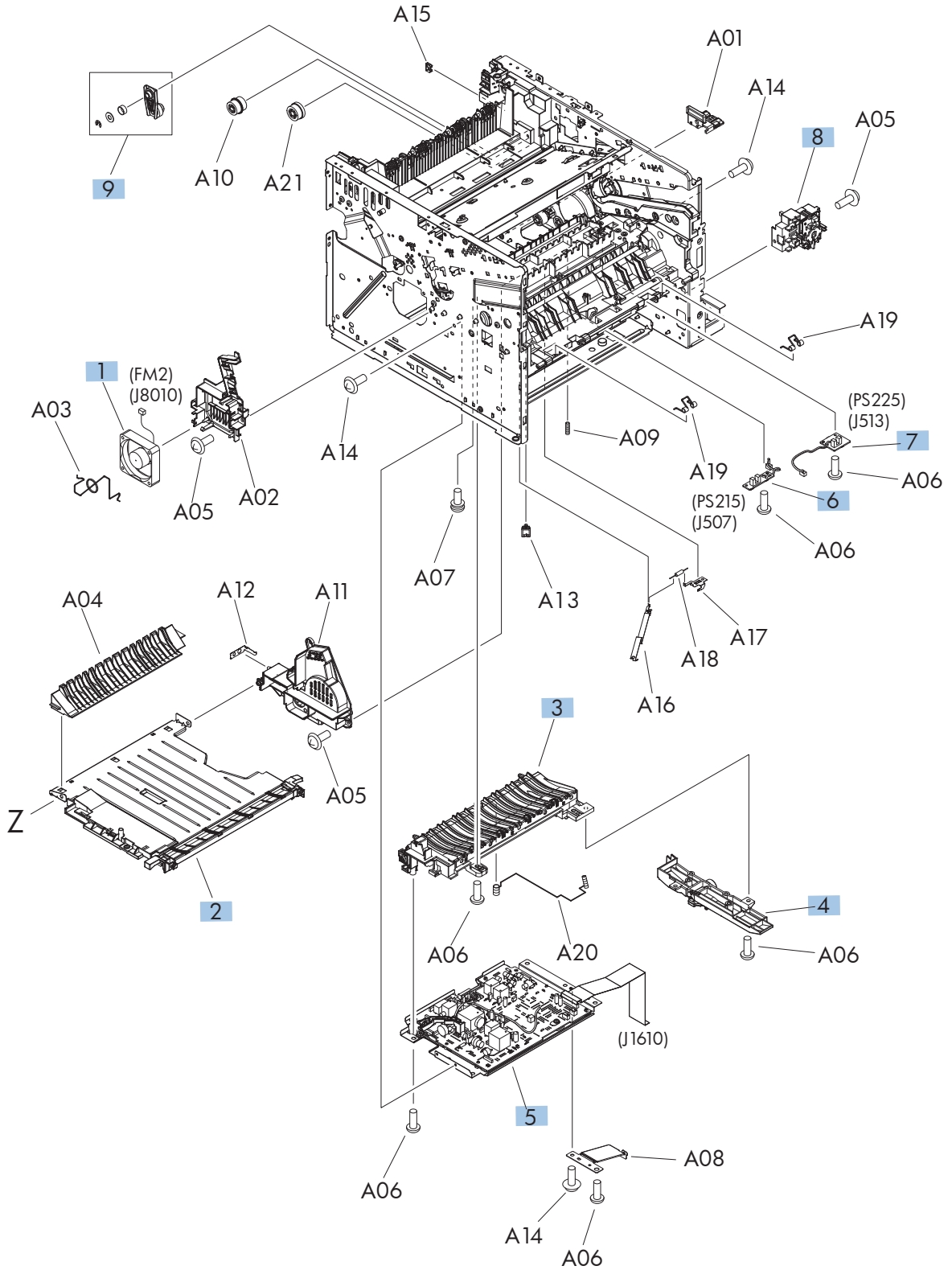


Table 2-13 Internal assemblies (4 of 6)

Ref	Description	Part number	Qty
1	Fan, sub	RK2-1499-000CN	1
2	Lower paper feed guide	RM1-6263-000CN	1
3	Paper-feed guide assembly	RM1-6270-000CN	1
4	Position-guide assembly	RM1-6273-000CN	1
5	High-voltage power supply (HVPS) PCA	RM1-8519-000CN	1
6	Top sensor PCA	RM1-8617-000CN	1
7	Paper-width sensor PCA	RM1-8618-000CN	1
8	Switch assembly	RM1-8515-000CN	1
9	Pendulum service kit	RM1-6598-000CN	1

Internal assemblies (5 of 6)

Figure 2-11 Internal assemblies (5 of 6)

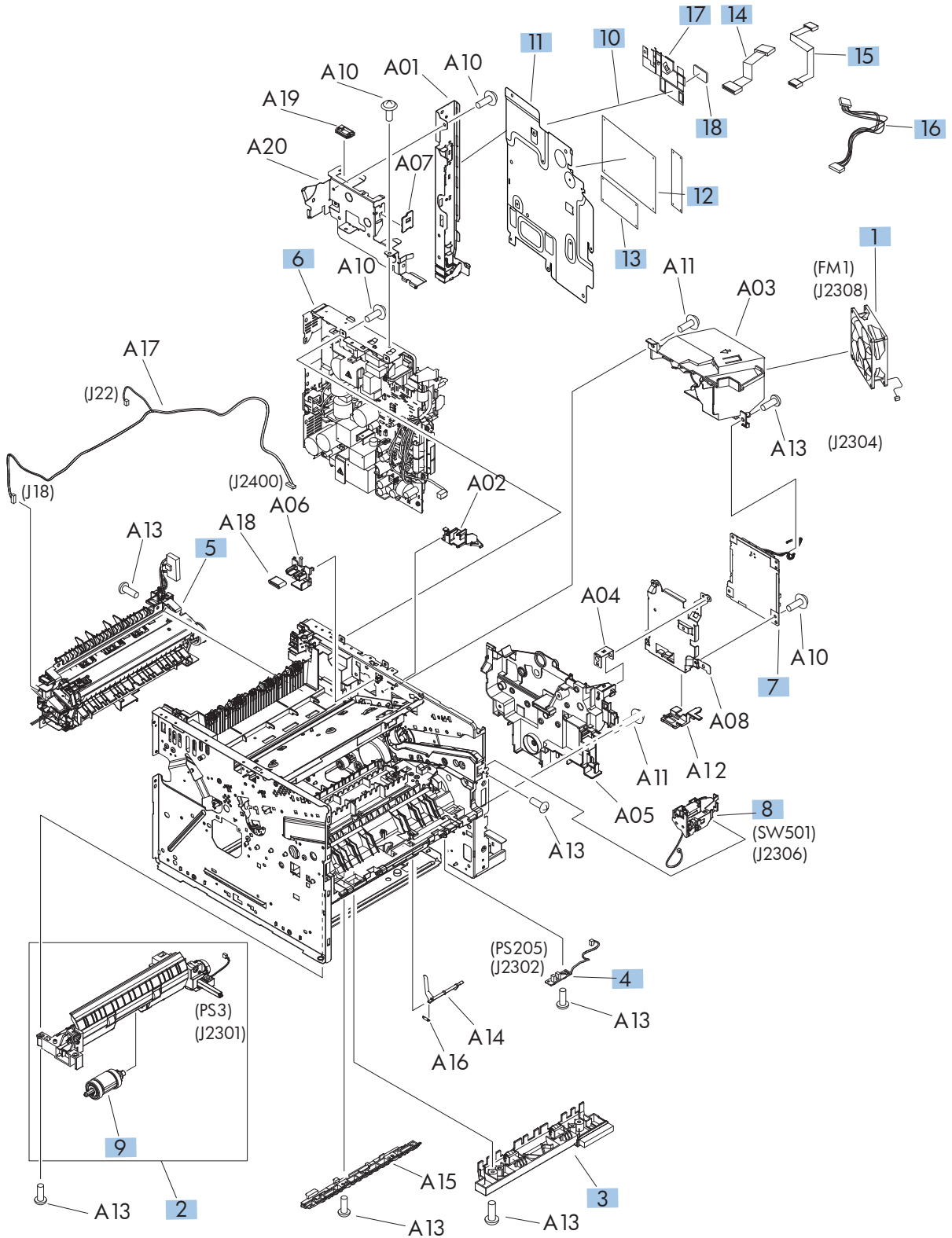


Table 2-14 Internal assemblies (5 of 6)

Ref	Description	Part number	Qty
1	Fan, main	RK2-2416-000CN	1
2	Tray 2, paper pickup assembly	RM1-8505-000CN	1
3	Idler roller assembly	RM1-8506-000CN	1
4	Multipurpose sensor PCA	RM1-8621-000CN	1
5	Fuser assembly	RM1-8508-000CN	1
6	Low-voltage power supply (LVPS) assembly	RM1-8514-000CN	1
7	DC controller PCA	RM1-8615-000CN	1
8	Interlock-switch assembly	RM1-8499-000CN	1
9	Assembly, cassette pick up roller (Tray 2 & 3 pickup roller)	RM1-6323-000CN	1
10	Formatter, standard	A8P80-60001	1
10	Formatter, China only	A8P79-60003	1
11	2 ports stay-FMTR	A8P79-00015	1
12	ICB	A8P79-60002	1
A01	I/O Plate, 2 ports	A8P79-00016	1
13	Fax PCA, U.S.	CF206-60001	1
13	Fax PCA, Europe	CF207-60001	1
13	Fax PCA, Brazil	CF208-60001	1
14	Fax, cable	A8P79-60105	1
15	Video FFC, ICB to formatter	A8P79-60128	1
16	Power cable, ICB to formatter	A8P79-60101	1
17	Guide, FFC	A8P79-40013	1
18	Ferrite core	9170-2640	1

Internal assemblies (6 of 6)

Figure 2-12 Internal assemblies (6 of 6)

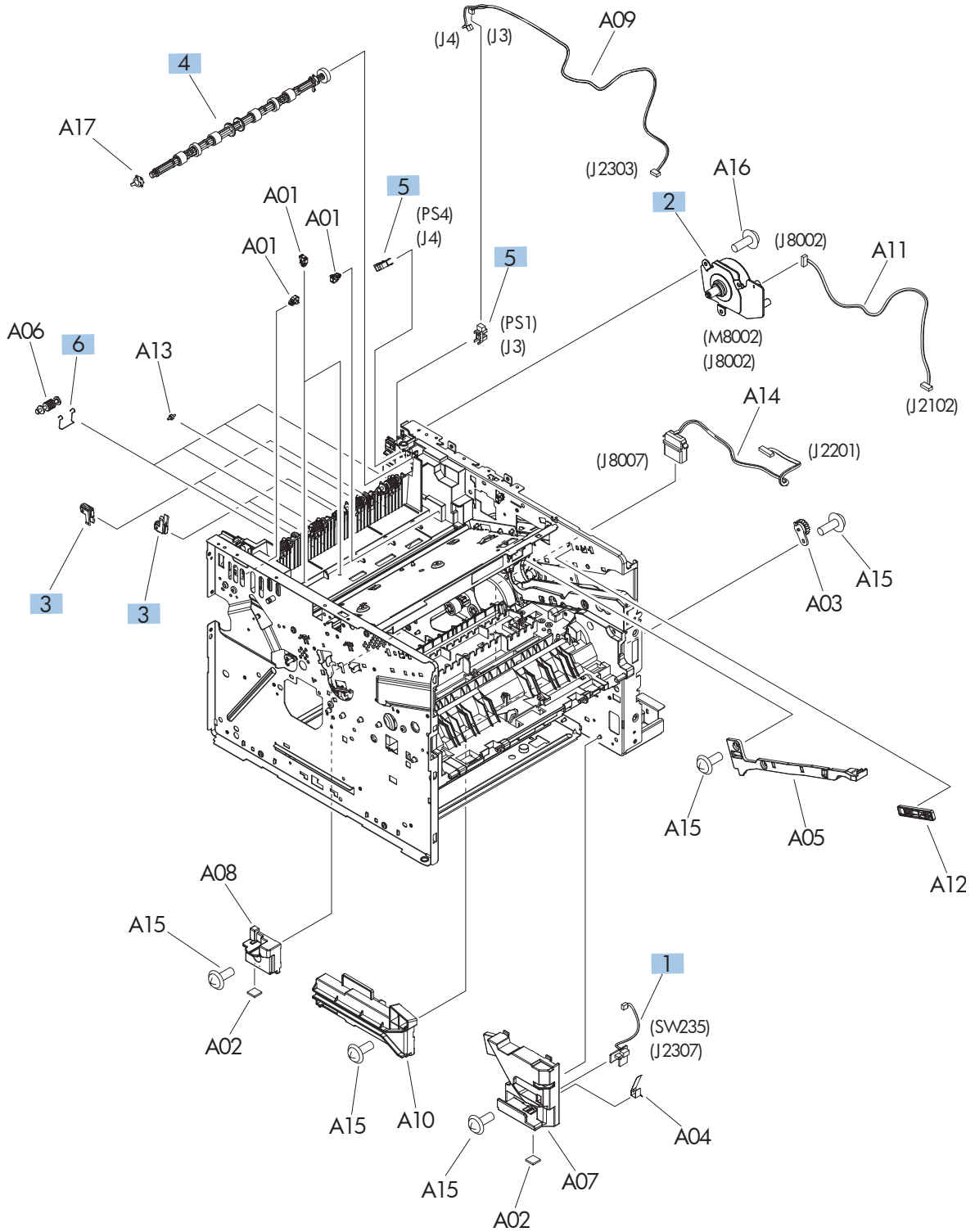


Table 2-15 Internal assemblies (6 of 6)

Ref	Description	Part number	Qty
1	Tray sensor PCA	RM1-8620-000CN	1
2	Fuser motor assembly	RM1-8523-000CN	1
3	Paper-delivery roller assembly	RM1-6301-000CN	4
4	Face-down roller assembly	RM1-6311-000CN	1
5	Photo interrupter, IC	WG8-5935-000CN	2
6	Spring, torsion	RC2-8554-000CN	1

Input devices

500-sheet input tray (Tray 3)

Figure 2-13 500-sheet input tray (Tray 3)

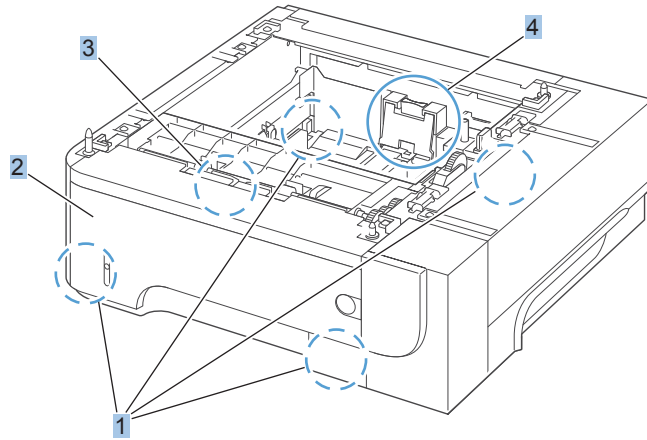


Table 2-16 500-sheet input tray (Tray 3)

Ref	Description	Part number	Qty
1	Optional 500-sheet tray and feeder unit	CE530-69001	1
2	Base-plate roller assembly	RM1-6306-000CN	4
3	Separation holder assembly	RM1-6303-000CN	1
4	Cassette, Tray 3	RM1-6279-000CN	1

Alphabetical parts list

Table 2-17 Alphabetical parts list

Description	Part number	Table and page
2 ports stay-FMTR	A8P79-00015	Internal assemblies (5 of 6) on page 163
ADF assembly	A8P79-60120	Document feeder and scanner assemblies on page 149
ADF assembly	A8P79-60120	Document feeder assemblies on page 153
ADF hinge assembly, left	CZ271-60020	Document feeder assemblies on page 153
ADF hinge assembly, right	A8P79-60011	Document feeder assemblies on page 153
ADF roller maintenance kit	A8P79-65001	Document feeder assemblies on page 153
ADF separation pad maintenance kit	A8P79-65010	Document feeder assemblies on page 153
ADF whole unit kit	A8P79-65014	Document feeder assemblies on page 153
Assembly, cassette pick up roller (Tray 2 & 3 pickup roller)	RM1-6323-000CN	Internal assemblies (5 of 6) on page 163
Base-plate roller assembly	RM1-6306-000CN	Internal assemblies (3 of 6) on page 159
Base-plate roller assembly	RM1-6306-000CN	500-sheet input tray (Tray 3) on page 167
Cable, flat	RK2-4218-000CN	Internal assemblies (1 of 6) on page 155
Cassette, Tray 2	RM1-8512-000CN	Internal assemblies (3 of 6) on page 159
Cassette, Tray 3	RM1-6279-000CN	500-sheet input tray (Tray 3) on page 167
Control-panel assembly	A8P79-60115	Document feeder and scanner assemblies on page 149
Control-panel assembly	A8P79-60115	Control-panel assembly on page 151
Control-panel FFC	A8P79-60106	Control-panel assembly on page 151
Cover kit, Tray 1	A8P80-65010	Covers on page 147
Cover, dummy	RC3-1920-000CN	Covers on page 147
Cover, formatter	RC3-1863-010CN	Covers on page 147

Table 2-17 Alphabetical parts list (continued)

Description	Part number	Table and page
Cover, handle, right	RC2-7675-000CN	Covers on page 147
Cover, left assembly	RM1-8517-000CN	Covers on page 147
Cover, rear assembly	RM1-8518-000CN	Covers on page 147
Cover, right assembly	RM1-8498-000CN	Covers on page 147
Cover, right rear	RC2-7673-000CN	Covers on page 147
Cover, top assembly	RM1-8516-000CN	Covers on page 147
DC controller PCA	RM1-8615-000CN	Internal assemblies (5 of 6) on page 163
Door, cartridge assembly	RM1-8502-000CN	Covers on page 147
Face-down roller assembly	RM1-6311-000CN	Internal assemblies (6 of 6) on page 165
Fan, main	RK2-2416-000CN	Internal assemblies (5 of 6) on page 163
Fan, sub	RK2-1499-000CN	Internal assemblies (4 of 6) on page 161
Fax PCA, Brazil	CF208-60001	Internal assemblies (5 of 6) on page 163
Fax PCA, Europe	CF207-60001	Internal assemblies (5 of 6) on page 163
Fax PCA, U.S.	CF206-60001	Internal assemblies (5 of 6) on page 163
Fax, cable	A8P79-60105	Internal assemblies (5 of 6) on page 163
Ferrite core	9170-2640	Internal assemblies (5 of 6) on page 163
Formatter, China only	A8P79-60003	Internal assemblies (5 of 6) on page 163
Formatter, standard	A8P80-60001	Internal assemblies (5 of 6) on page 163
Fuser assembly	RM1-8508-000CN	Internal assemblies (5 of 6) on page 163
Fuser motor assembly	RM1-8523-000CN	Internal assemblies (6 of 6) on page 165
Guide, FFC	A8P79-40013	Internal assemblies (5 of 6) on page 163
High-voltage power supply (HVPS) PCA	RM1-8519-000CN	Internal assemblies (4 of 6) on page 161
I/O Plate, 2 ports	A8P79-00016	Internal assemblies (5 of 6) on page 163

Table 2-17 Alphabetical parts list (continued)

Description	Part number	Table and page
ICB	A8P79-60002	Internal assemblies (5 of 6) on page 163
Idler roller assembly	RM1-8506-000CN	Internal assemblies (5 of 6) on page 163
Interlock-switch assembly	RM1-8499-000CN	Internal assemblies (5 of 6) on page 163
Laser/scanner	RM1-6322-000CN	Internal assemblies (1 of 6) on page 155
Low-voltage power supply (LVPS) assembly	RM1-8514-000CN	Internal assemblies (5 of 6) on page 163
Lower paper feed guide	RM1-6263-000CN	Internal assemblies (4 of 6) on page 161
Multipurpose lifting plate assembly	RM1-6325-000CN	Covers on page 147
Multipurpose sensor PCA	RM1-8621-000CN	Internal assemblies (5 of 6) on page 163
Optional 500-sheet tray and feeder unit	CE530-69001	500-sheet input tray (Tray 3) on page 167
Pad, multipurpose separation	RC2-8575-000CN	Internal assemblies (3 of 6) on page 159
Paper-delivery roller assembly	RM1-6301-000CN	Internal assemblies (6 of 6) on page 165
Paper-feed guide assembly	RM1-6270-000CN	Internal assemblies (4 of 6) on page 161
Paper-width sensor PCA	RM1-8618-000CN	Internal assemblies (4 of 6) on page 161
Pendulum service kit	RM1-6598-000CN	Internal assemblies (4 of 6) on page 161
Photo interrupter, IC	WG8-5935-000CN	Internal assemblies (1 of 6) on page 155
Photo interrupter, IC	WG8-5935-000CN	Internal assemblies (6 of 6) on page 165
Position-guide assembly	RM1-6273-000CN	Internal assemblies (4 of 6) on page 161
Power cable, ICB to formatter	A8P79-60101	Internal assemblies (5 of 6) on page 163
Registration roller assembly	RM1-8507-000CN	Internal assemblies (3 of 6) on page 159
Roller, multipurpose	RL1-2412-000CN	Internal assemblies (3 of 6) on page 159

Table 2-17 Alphabetical parts list (continued)

Description	Part number	Table and page
Roller, transfer	RM1-6321-000CN	Internal assemblies (3 of 6) on page 159
Scanner assembly	A8P79-60121	Document feeder and scanner assemblies on page 149
Sensor, environmental PCA	RM1-8622-000CN	Internal assemblies (1 of 6) on page 155
Separation holder assembly	RM1-6303-000CN	Internal assemblies (3 of 6) on page 159
Separation holder assembly	RM1-6303-000CN	500-sheet input tray (Tray 3) on page 167
Spring, torsion	RC2-8554-000CN	Internal assemblies (6 of 6) on page 165
Stopper, bushing arm	RC2-7928-000CN	Internal assemblies (1 of 6) on page 155
Switch assembly	RM1-8515-000CN	Internal assemblies (4 of 6) on page 161
Tag holder assembly	RM1-8521-000CN	Internal assemblies (1 of 6) on page 155
Top sensor PCA	RM1-8617-000CN	Internal assemblies (4 of 6) on page 161
Transfer lower guide assembly	RM1-6315-000CN	Internal assemblies (3 of 6) on page 159
Tray 2, paper pickup assembly	RM1-8505-000CN	Internal assemblies (5 of 6) on page 163
Tray sensor PCA	RM1-8620-000CN	Internal assemblies (6 of 6) on page 165
Tray 1 solenoid	RK2-1490-000CN	Internal assemblies (2 of 6) on page 157
Tray 2 solenoid	RK2-1492-000CN	Internal assemblies (2 of 6) on page 157
USB cable	A8P79-60102	Control-panel assembly on page 151
USB PCA	CF368-60001	Control-panel assembly on page 151
Video FFC, ICB to formatter	A8P79-60128	Internal assemblies (5 of 6) on page 163
Wi-Fi cable	A8P80-60101	Document feeder and scanner assemblies on page 149
Wi-Fi module	1150-7957	Document feeder and scanner assemblies on page 149

Numerical parts list

Table 2-18 Numerical parts list

Part number	Description	Table and page
1150-7957	Wi-Fi module	Document feeder and scanner assemblies on page 149
9170-2640	Ferrite core	Internal assemblies (5 of 6) on page 163
A8P79-00015	2 ports stay-FMTR	Internal assemblies (5 of 6) on page 163
A8P79-00016	I/O Plate, 2 ports	Internal assemblies (5 of 6) on page 163
A8P79-40013	Guide, FFC	Internal assemblies (5 of 6) on page 163
A8P79-60002	ICB	Internal assemblies (5 of 6) on page 163
A8P79-60003	Formatter, China only	Internal assemblies (5 of 6) on page 163
A8P79-60011	ADF hinge assembly, right	Document feeder assemblies on page 153
A8P79-60101	Power cable, ICB to formatter	Internal assemblies (5 of 6) on page 163
A8P79-60102	USB cable	Control-panel assembly on page 151
A8P79-60105	Fax, cable	Internal assemblies (5 of 6) on page 163
A8P79-60106	Control-panel FFC	Control-panel assembly on page 151
A8P79-60115	Control-panel assembly	Document feeder and scanner assemblies on page 149
A8P79-60115	Control-panel assembly	Control-panel assembly on page 151
A8P79-60120	ADF assembly	Document feeder and scanner assemblies on page 149
A8P79-60120	ADF assembly	Document feeder assemblies on page 153
A8P79-60121	Scanner assembly	Document feeder and scanner assemblies on page 149
A8P79-60128	Video FFC, ICB to formatter	Internal assemblies (5 of 6) on page 163
A8P79-65001	ADF roller maintenance kit	Document feeder assemblies on page 153

Table 2-18 Numerical parts list (continued)

Part number	Description	Table and page
A8P79-65010	ADF separation pad maintenance kit	Document feeder assemblies on page 153
A8P79-65014	ADF whole unit kit	Document feeder assemblies on page 153
A8P80-60001	Formatter, standard	Internal assemblies (5 of 6) on page 163
A8P80-60101	Wi-Fi cable	Document feeder and scanner assemblies on page 149
A8P80-65010	Cover kit, Tray 1	Covers on page 147
CE530-69001	Optional 500-sheet tray and feeder unit	500-sheet input tray (Tray 3) on page 167
CF206-60001	Fax PCA, U.S.	Internal assemblies (5 of 6) on page 163
CF207-60001	Fax PCA, Europe	Internal assemblies (5 of 6) on page 163
CF208-60001	Fax PCA, Brazil	Internal assemblies (5 of 6) on page 163
CF368-60001	USB PCA	Control-panel assembly on page 151
CZ271-60020	ADF hinge assembly, left	Document feeder assemblies on page 153
RC2-7673-000CN	Cover, right rear	Covers on page 147
RC2-7675-000CN	Cover, handle, right	Covers on page 147
RC2-7928-000CN	Stopper, bushing arm	Internal assemblies (1 of 6) on page 155
RC2-8554-000CN	Spring, torsion	Internal assemblies (6 of 6) on page 165
RC2-8575-000CN	Pad, multipurpose separation	Internal assemblies (3 of 6) on page 159
RC3-1863-010CN	Cover, formatter	Covers on page 147
RC3-1920-000CN	Cover, dummy	Covers on page 147
RK2-1490-000CN	Tray 1 solenoid	Internal assemblies (2 of 6) on page 157
RK2-1492-000CN	Tray 2 solenoid	Internal assemblies (2 of 6) on page 157
RK2-1499-000CN	Fan, sub	Internal assemblies (4 of 6) on page 161
RK2-2416-000CN	Fan, main	Internal assemblies (5 of 6) on page 163

Table 2-18 Numerical parts list (continued)

Part number	Description	Table and page
RK2-4218-000CN	Cable, flat	Internal assemblies (1 of 6) on page 155
RL1-2412-000CN	Roller, multipurpose	Internal assemblies (3 of 6) on page 159
RM1-6263-000CN	Lower paper feed guide	Internal assemblies (4 of 6) on page 161
RM1-6270-000CN	Paper-feed guide assembly	Internal assemblies (4 of 6) on page 161
RM1-6273-000CN	Position-guide assembly	Internal assemblies (4 of 6) on page 161
RM1-6279-000CN	Cassette, Tray 3	500-sheet input tray (Tray 3) on page 167
RM1-6301-000CN	Paper-delivery roller assembly	Internal assemblies (6 of 6) on page 165
RM1-6303-000CN	Separation holder assembly	Internal assemblies (3 of 6) on page 159
RM1-6303-000CN	Separation holder assembly	500-sheet input tray (Tray 3) on page 167
RM1-6306-000CN	Base-plate roller assembly	Internal assemblies (3 of 6) on page 159
RM1-6306-000CN	Base-plate roller assembly	500-sheet input tray (Tray 3) on page 167
RM1-6311-000CN	Face-down roller assembly	Internal assemblies (6 of 6) on page 165
RM1-6315-000CN	Transfer lower guide assembly	Internal assemblies (3 of 6) on page 159
RM1-6321-000CN	Roller, transfer	Internal assemblies (3 of 6) on page 159
RM1-6322-000CN	Laser/scanner	Internal assemblies (1 of 6) on page 155
RM1-6323-000CN	Assembly, cassette pick up roller (Tray 2 & 3 pickup roller)	Internal assemblies (5 of 6) on page 163
RM1-6325-000CN	Multipurpose lifting plate assembly	Covers on page 147
RM1-6598-000CN	Pendulum service kit	Internal assemblies (4 of 6) on page 161
RM1-8498-000CN	Cover, right assembly	Covers on page 147
RM1-8499-000CN	Interlock-switch assembly	Internal assemblies (5 of 6) on page 163
RM1-8502-000CN	Door, cartridge assembly	Covers on page 147

Table 2-18 Numerical parts list (continued)

Part number	Description	Table and page
RM1-8505-000CN	Tray 2, paper pickup assembly	Internal assemblies (5 of 6) on page 163
RM1-8506-000CN	Idler roller assembly	Internal assemblies (5 of 6) on page 163
RM1-8507-000CN	Registration roller assembly	Internal assemblies (3 of 6) on page 159
RM1-8508-000CN	Fuser assembly	Internal assemblies (5 of 6) on page 163
RM1-8512-000CN	Cassette, Tray 2	Internal assemblies (3 of 6) on page 159
RM1-8514-000CN	Low-voltage power supply (LVPS) assembly	Internal assemblies (5 of 6) on page 163
RM1-8515-000CN	Switch assembly	Internal assemblies (4 of 6) on page 161
RM1-8516-000CN	Cover, top assembly	Covers on page 147
RM1-8517-000CN	Cover, left assembly	Covers on page 147
RM1-8518-000CN	Cover, rear assembly	Covers on page 147
RM1-8519-000CN	High-voltage power supply (HVPS) PCA	Internal assemblies (4 of 6) on page 161
RM1-8521-000CN	Tag holder assembly	Internal assemblies (1 of 6) on page 155
RM1-8523-000CN	Fuser motor assembly	Internal assemblies (6 of 6) on page 165
RM1-8615-000CN	DC controller PCA	Internal assemblies (5 of 6) on page 163
RM1-8617-000CN	Top sensor PCA	Internal assemblies (4 of 6) on page 161
RM1-8618-000CN	Paper-width sensor PCA	Internal assemblies (4 of 6) on page 161
RM1-8620-000CN	Tray sensor PCA	Internal assemblies (6 of 6) on page 165
RM1-8621-000CN	Multipurpose sensor PCA	Internal assemblies (5 of 6) on page 163
RM1-8622-000CN	Sensor, environmental PCA	Internal assemblies (1 of 6) on page 155
WG8-5935-000CN	Photo interrupter, IC	Internal assemblies (6 of 6) on page 165
WG8-5935-000CN	Photo interrupter, IC	Internal assemblies (1 of 6) on page 155

Index

A

- accessories
 - ordering 140
- after service checklist 5

C

- cartridge
 - ordering 140
 - part number 140
 - removing 11
- cartridge door
 - removing 34
- cassette 13
 - Tray 2, removing 13
 - Tray 3, removing 13
- cautions iii
- checklists
 - after service 5
 - preservice 5
- control-panel assembly
 - removing 59
- conventions, document iii

D

- DC controller
 - removing 102
- document conventions iii
- Document feeder hinge assembly
 - removing 57
- Document feeder whole unit kit
 - removing 52
- document feeder/scanner assembly
 - removing 46
- dummy cover
 - removing 23
- duplex paper-feed
 - removing 83

E

- electrostatic discharge (ESD) 2
- environmental sensor
 - removing 128
- ESD (electrostatic discharge) 2

F

- fasteners
 - screws 142
- Fax PCA and cable
 - removing 20
- formatter cover
 - removing 18
- formatter PCA
 - removing 19
- fuser
 - removing 80
- fuser motor
 - removing 120

H

- high-voltage power supply (HVPS)
 - removing 130

I

- interlock switch assembly
 - removing 89

L

- laser scanner
 - removing 98
- left cover
 - removing 28
- location
 - covers 146
 - internal assemblies 154
 - optional trays or accessories (base product) 144

- low-voltage power supply
 - removing 106

M

- main fan
 - removing 93

N

- notes iii

O

- ordering
 - print cartridge 140
 - product documents 142
 - supplies and accessories 140

P

- part number
 - print cartridge 140
- part numbers
 - screws 142
- parts
 - 500-sheet input tray 166
 - control panel 150
 - covers 146
 - internal assemblies 154
 - optional trays or accessories (base product) 144
- pendulum
 - removing 121
- post-service tests 5
- power-switch assembly
 - removing 88
- preservice checklist 5
- print cartridge
 - ordering 140
 - part number 140
- print-quality test 5

R

- rear cover assembly
 - removing 24
- registration roller assembly
 - removing 86
- removing parts 74, 76
 - cartridge door 34
 - cautions for 2
 - checklists 5
 - control-panel assembly 59
 - DC controller 102
 - Document feeder hinge assembly 57
 - Document feeder whole unit kit 52
 - document feeder/scanner assembly 46
 - dummy cover 23
 - duplex paper-feed 83
 - environmental sensor 128
 - Fax PCA and cable 20
 - formatter cover 18
 - formatter PCA 19
 - fuser 80
 - fuser motor 120
 - high-voltage power supply (HVPS) 130
 - interlock switch assembly 89
 - laser scanner 98
 - left cover 28
 - low-voltage power supply 106
 - main fan 93
 - pendulum 121
 - power-switch assembly 88
 - rear cover assembly 24
 - registration roller assembly 86
 - right cover assembly 36
 - right handle cover 41
 - right-rear cover 30
 - service approach 5
 - sub cover 11
 - sub fan 124
 - tag holder assembly 101
 - toner cartridge 11
 - top cover 95
 - transfer roller 78
 - tray 1 cover 32
 - Tray 1 pickup roller 16, 71
 - Tray 1 pickup solenoid 118
 - Tray 1 separation pad 17, 73

- Tray 2 base-plate roller 76
- Tray 2 paper pickup assembly 112
- Tray 2 pickup roller 14, 74
- Tray 2 pickup solenoid 118
- Tray 2 separation holder 76
- Tray 3 base-plate roller 76
- Tray 3 pickup roller 14, 74
- Tray 3 separation holder 76
- tray cassette 13
- tray sensor PCA 91
- USB cover 57
- repair approach 5
- replacing parts
 - cautions for 2
 - service approach 5
- right cover assembly
 - removing 36
- right handle cover
 - removing 41
- right-rear cover
 - removing 30

S

- screwdrivers, required 3
- screws
 - part numbers 142
 - replacing 2
 - types of 3
- service
 - approach 5
- static precautions 2
- sub cover
 - removing 11
- sub fan
 - removing 124
- supplies
 - ordering 140

T

- tag holder assembly
 - removing 101
- tests
 - post-service 5
 - print-quality 5
- tips iii
- toner cartridge
 - removing 11
- tools, required 3

- top cover
 - removing 95
- transfer roller
 - removing 78
- tray 1 cover
 - removing 32
- Tray 1 pickup roller
 - removing 16, 71
- Tray 1 pickup solenoid
 - removing 118
- Tray 1 separation pad
 - removing 17, 73
- Tray 2 base-plate roller
 - removing 76
- Tray 2 paper pickup assembly
 - removing 112
- Tray 2 pickup roller
 - removing 14, 74
- Tray 2 pickup solenoid
 - removing 118
- Tray 2 separation holder
 - removing 76
- Tray 3 base-plate roller
 - removing 76
- Tray 3 pickup roller
 - removing 14, 74
- Tray 3 separation holder
 - removing 76
- tray sensor PCA
 - removing 91
- trays
 - removing 13
- troubleshooting
 - service approach 5

U

- USB cover
 - removing 57

W

- warnings iii



A8P79-90904

