



Service Manual



Laser Printer

ML-1660/1665

The keynote of Product

1. Speed
 - Up to 16 ppm in A4 (17 ppm in Letter)
2. Processor
 - Jupiter4e 150 MHz
3. Printer Language
 - GDI
4. Memory
 - 8 MB
5. Interfaces
 - Compatible with USB 2.0
6. Toner cartridge
 - Initial : 0.7K
 - Sales : 1.5K



GSPN (Global Service Partner Network)

North America : service.samsungportal.com

Latin America : latin.samsungportal.com

CIS : cis.samsungportal.com

Europe : europe.samsungportal.com

China : china.samsungportal.com

Asia : asia.samsungportal.com

Mideast & Africa : mea.samsungportal.com

© Samsung Electronics Co.,Ltd. December. 2009
Printed in Korea.

VERSION NO. : 1.00 CODE : 1660-0000E

chapter 1 *Precautions*

1.1 Safety Warning	1-1
1.2 Caution for safety	1-2
1.2.1 Toxic material	1-2
1.2.2 Electric Shock and Fire Safety Precautions	1-2
1.2.3 Handling Precautions	1-3
1.2.4 Assembly / Disassembly Precautions	1-3
1.2.5 Disregarding this warning may cause bodily injury	1-4
1.3 ESD Precautions	1-5

chapter 2 *Product Overview*

2.1 Product Specifications	2-1
2.1.1 Product Overview	2-1
2.1.2 Specifications.....	2-2
2.1.3 Model Comparison Table	2-7
2.2 System Overview	2-8
2.2.1 Front View	2-8
2.2.2 Rear View	2-9
2.2.3 System Layout	2-10
2.2.4 Engine H/W Specifications	2-17
2.2.5 Engine F/W Control Algorithm	2-23
2.2.6 S/W Descriptions	2-25

chapter 3 *Maintenance and Disassembly*

3.1 Precautions when replacing parts	3-1
3.1.1 Precautions when assembling and disassembling	3-1
3.1.2 Precautions when handling PBA	3-1
3.1.3 Releasing Plastic Latches	3-1

3.2	Screws used in the printer	3-2
3.3	Cover	3-3
3.3.1	Left/Right cover	3-3
3.3.2	Rear bracket	3-3
3.3.3	Cover-open	3-4
3.3.4	Top/Front cover	3-4
3.4	Main PBA	3-5
3.5	SMPS/HVPS board	3-6
3.6	Fuser unit	3-7
3.7	LSU	3-8
3.8	Drive unit	3-9
3.9	Step motor	3-10
3.10	Pick up roller	3-11

chapter 4 *Alignment and Troubleshooting*

4.1	Alignment and Adjustments	4-1
4.1.1	Control Panel	4-1
4.1.2	Understanding the LEDs	4-2
4.1.3	JAM Removal	4-3
4.1.4	Printing a report	4-5
4.1.5	Periodic Defective Image	4-8
4.1.6	Firmware upgrade	4-9
4.1.7	Using the smart panel program	4-10
4.2	Troubleshooting	4-12
4.2.1	Procedure of Checking the Symptoms	4-12
4.2.2	Bad discharge	4-15
4.2.3	Malfunction	4-19
4.2.4	Bad image	4-24

chapter 5 *System Diagram*

5.1 Block Diagram	5-1
5.2 Connection Diagram.....	5-2

chapter 6 *Reference Information*

6.1 Tool for Troubleshooting	6-1
6.2 Acronyms and Abbreviations	6-2
6.2.1 Acronyms	6-2
6.2.2 Service Parts	6-4
6.3 A4 ISO 19798 Standard Pattern.....	6-8
6.3.1 A4 ISO 19752 Standard Pattern	6-8
6.4 Selecting a location	6-9

attached *Exploded Views & Parts List*

1. Precautions

In order to prevent accidents and damages to the equipment please read the precautions listed below carefully before servicing the product and follow them closely.

1.1 Safety warning

(1) Only to be serviced by a factory trained service technician.

High voltages and lasers inside this product are dangerous. This product should only be serviced by a factory trained service technician.

(2) Use only Samsung replacement parts.

There are no user serviceable parts inside the product. Do not make any unauthorized changes or additions to the product as these could cause the product to malfunctions and create an electric shocks or fire hazards.

(3) Laser Safety Statement

The product is certified in the U.S. to conform to the requirements of DHHS 21 CFR, chapter 1 Subchapter J for Class 1(1) laser products, and elsewhere, it is certified as a Class I laser product conforming to the requirements of IEC 825. Class I laser products are not considered to be hazardous. The laser system and product are designed so there is never any human access to laser radiation above a Class I level during normal operation, user maintenance, or prescribed service condition.

Warning >> Never operate or service the product with the protective cover removed from Laser/Scanner assembly. The reflected beam, although invisible, can damage your eyes. When using this product, these basic safety pre-cautions should always be followed to reduce risk of fire, electric shock, and personal injury.



CAUTION - INVISIBLE LASER RADIATION
WHEN THIS COVER OPEN.
DO NOT OPEN THIS COVER.

VORSICHT - UNSICHTBARE LASERSTRAHLUNG,
WENN ABDECKUNG GE...FFNET.
NICHT DEM STRAHL AUSSETZEN.

ATTENTION - RAYONNEMENT LASER INVISIBLE EN CAS
D'OUVERTURE. EXPOSITION DANGEREUSE
AU FAISCEAU.

ATTENZIONE - RADIAZIONE LASER INVISIBLE IN CASO DI
APERTURA. EVITARE L'ESPOSIZIONE AL
FASCIO.

PRECAUCION - RADIACION LASER IVISIBLE CUANDO SE ABRE.
EVITAR EXPONERSE AL RAYO.

ADVARSEL - USYNLIG LASERSTRLNING VED BNING, NR
SIKKERHEDSBRYDERE ER UDE AF FUNKTION.
UNNG UDSAETTEELSE FOR STRLNING.

ADVARSEL - USYNLIG LASERSTRLNING NR DEKSEL
PNES. STIRR IKKE INN I STRLEN.
UNNG EKSPONERING FOR STRLEN.

VARNING - OSYNLIG LASERSTRLNING NR DENNA DEL
R...PPNAD OCH SPRREN R URKOPPLAD.
BETRAKTA EJ STRLEN. STRLEN R FARLIG.

VARO! - AVATTAESSA JA SUOJALUKITUS OHITETTAESSA
OLET ALTIINA NKYMTT...MLLE LASER-
STEILYLLE L KATSO STEESEEN.

注 意 - 严禁揭开此盖, 以免激光泄露灼伤

주 의 - 이 덮개를 열면 레이저광에 노출될 수 있으므로
주의하십시오.

1.2 Caution for safety

1.2.1 Toxic material

This product contains toxic materials that could cause illness if ingested.

- (1) If the LCD control panel is damaged, it is possible for the liquid inside to leak. This liquid is toxic. Contact with the skin should be avoided. Wash any splashes from eyes or skin immediately and contact your doctor. If the liquid gets into the mouth or is swallowed, see a doctor immediately.
- (2) Please keep imaging unit and toner cartridge away from children. The toner powder contained in the imaging unit and toner cartridge may be harmful, and if swallowed, you should contact a doctor.

1.2.2 Electric shock and fire safety precautions

Failure to follow the following instructions could cause electric shock or potentially cause a fire.

- (1) Use only the correct voltage, failure to do so could damage the product and potentially cause a fire or electric shock.
- (2) Use only the power cable supplied with the product. Use of an incorrectly specified cable could cause the cable to overheat and potentially cause a fire.
- (3) Do not overload the power socket, this could lead to overheating of the cables inside the wall and could lead to a fire.
- (4) Do not allow water or other liquids to spill into the product, this can cause electric shock. Do not allow paper clips, pins or other foreign objects to fall into the product, these could cause a short circuit leading to an electric shock or fire hazard.
- (5) Never touch the plugs on either end of the power cable with wet hands, this can cause electric shock. When servicing the product, remove the power plug from the wall socket.
- (6) Use caution when inserting or removing the power connector. When removing the power connector, grip it firmly and pull. The power connector must be inserted completely, otherwise a poor contact could cause overheating possibly leading to a fire.
- (7) Take care of the power cable. Do not allow it to become twisted, bent sharply around corners or wise damaged. Do not place objects on top of the power cable. If the power cable is damaged it could overheat and cause a fire. Exposed cables could cause an electric shock. Replace the damaged power cable immediately, do not reuse or repair the damaged cable. Some chemicals can attack the coating on the power cable, weakening the cover or exposing cables causing fire and shock risks.
- (8) Ensure that the power sockets and plugs are not cracked or broken in any way. Any such defects should be repaired immediately. Take care not to cut or damage the power cable or plugs when moving the machine.
- (9) Use caution during thunder or lightning storms. Samsung recommends that this machine be disconnected from the power source when such weather conditions are expected. Do not touch the machine or the power cord if it is still connected to the wall socket in these weather conditions.
- (10) Avoid damp or dusty areas, install the product in a clean well ventilated location. Do not position the machine near a humidifier or in front of an air conditioner. Moisture and dust built up inside the machine can lead to overheating and cause a fire or cause parts to rust.
- (11) Do not position the product in direct sunlight. This will cause the temperature inside the product to rise possibly leading to the product failing to work properly and in extreme conditions could lead to a fire.
- (12) Do not insert any metal objects into the machine through the ventilator fan or other part of the casing, it could make contact with a high voltage conductor inside the machine and cause an electric shock.

1.2.3 Handling precautions

The following instructions are for your own personal safety to avoid injury and so as not to damage the product.

- (1) Ensure the product is installed on a level surface, capable of supporting its weight. Failure to do so could cause the product to tip or fall.
- (2) The product contains many rollers, gears and fans. Take great care to ensure that you do not catch your fingers, hair or clothing in any of these rotating devices.
- (3) Do not place any small metal objects, containers of water, chemicals or other liquids close to the product which if spilled could get into the machine and cause damage or a shock or fire hazard.
- (4) Do not install the machine in areas with high dust or moisture levels, beside an open window or close to a humidifier or heater. Damage could be caused to the product in such areas.
- (5) Do not place candles, burning cigarettes, etc on the product, These could cause a fire.

1.2.4 Assembly / Disassembly precautions

Replace parts carefully and always use Samsung parts. Take care to note the exact location of parts and also cable routing before dismantling any part of the machine. Ensure all parts and cables are replaced correctly. Please carry out the following procedures before dismantling the product or replacing any parts.

- (1) Check the contents of the machine memory and make a note of any user settings. These will be erased if the main board or network card is replaced.
- (2) Ensure that power is disconnected before servicing or replacing any electrical parts.
- (3) Disconnect interface cables and power cables.
- (4) Only use approved spare parts. Ensure that part number, product name, any voltage, current or temperature rating are correct.
- (5) When removing or re-fitting any parts do not use excessive force, especially when fitting screws into plastic.
- (6) Take care not to drop any small parts into the machine.
- (7) Handling of the OPC Drum
 - The OPC Drum can be irreparably damaged if it is exposed to light. Take care not to expose the OPC Drum either to direct sunlight or to fluorescent or incandescent room lighting. Exposure for as little as 5 minutes can damage the surface of the photoconductive properties and will result in print quality degradation. Take extra care when servicing the product. Remove the OPC Drum and store it in a black bag or other lightproof container. Take care when working with the Covers (especially the top cover) open as light is admitted to the OPC area and can damage the OPC Drum.
 - Take care not to scratch the green surface of the OPC Drum Unit. If the green surface of the Drum Cartridge is scratched or touched the print quality will be compromised.

1.2.5 Disregarding this warning may cause bodily injury

- (1) Be careful with the high temperature part.
The fuser unit works at a high temperature. Use caution when working on the printer. Wait for the fuser to cool down before disassembly.
- (2) Do not put finger or hair into the rotating parts.
When operating a printer, do not put hand or hair into the rotating parts (Paper feeding entrance, motor, fan, etc.). If do, you can get harm.
- (3) When you move the printer.
This printer weighs 6kg including toner cartridge and cassette. Use safe lifting and handling techniques. Use the lifting handles located on each side of the machine. Back injury could be caused if you do not lift carefully.
- (4) Ensure the printer is installed safely.
The printer weighs 6kg, ensure the printer is installed on a level surface, capable of supporting its weight. Failure to do so could cause the printer to tip or fall possibly causing personal injury or damaging the printer.
- (5) Do not install the printer on a sloping or unstable surface. After installation, double check that the printer is stable.

1.3 ESD precautions

Certain semiconductor devices can be easily damaged by static electricity. Such components are commonly called “Electrostatically Sensitive (ES) Devices” or ESDs. Examples of typical ESDs are: integrated circuits, some field effect transistors, and semiconductor “chip” components.

The techniques outlined below should be followed to help reduce the incidence of component damage caused by static electricity.

Caution >>Be sure no power is applied to the chassis or circuit, and observe all other safety precautions.

1. Immediately before handling a semiconductor component or semiconductor-equipped assembly, drain off any electrostatic charge on your body by touching a known earth ground. Alternatively, employ a commercially available wrist strap device, which should be removed for your personal safety reasons prior to applying power to the unit under test.
2. After removing an electrical assembly equipped with ESDs, place the assembly on a conductive surface, such as aluminum or copper foil, or conductive foam, to prevent electrostatic charge buildup in the vicinity of the assembly.
3. Use only a grounded tip soldering iron to solder or desolder ESDs.
4. Use only an “anti-static” solder removal device. Some solder removal devices not classified as “anti-static” can generate electrical charges sufficient to damage ESDs.
5. Do not use Freon-propelled chemicals. When sprayed, these can generate electrical charges sufficient to damage ESDs.
6. Do not remove a replacement ESD from its protective packaging until immediately before installing it. Most replacement ESDs are packaged with all leads shorted together by conductive foam, aluminum foil, or a comparable conductive material.
7. Immediately before removing the protective shorting material from the leads of a replacement ESD, touch the protective material to the chassis or circuit assembly into which the device will be installed.
8. Maintain continuous electrical contact between the ESD and the assembly into which it will be installed, until completely plugged or soldered into the circuit.
9. Minimize bodily motions when handling unpackaged replacement ESDs. Normal motions, such as the brushing together of clothing fabric and lifting one’s foot from a carpeted floor, can generate static electricity sufficient to damage an ESD.

2. Product spec and feature

2.1 Product Specifications

2.1.1 Product Overview



ML- 1660

1. Speed
 - Up to 16 ppm in A4 (17 ppm in Letter)
2. Processor
 - Jupiter4e 150 MHz
3. Printer Language
 - GDI
4. Memory
 - 8 MB
5. Interfaces
 - Compatible with USB 2.0
6. Toner cartridge
 - Initial : 0.7K
 - Sales : 1.5K

2.1.2 Specifications

- Product Specifications are subject to change without notice. See below for product specifications.

2.1.2.1 General Print Engine

Items		Specification
Engine Speed	Simplex	Up to 16 ppm in A4 (17 ppm in Letter)
	Duplex	Manual
Warmup time	From Sleep	≤ 30 sec
FPOT	From Ready	≤ 10 sec
	From Sleep	≤ 30 sec
Resolution		Up to 1200 x 600 dpi effective output

2.1.2.2 Controller & S/W

Items		Specification
Processor		Jupiter4e 150 MHz
Memory	Std.	8 MB
	Option	N/A
Printer Languages	GDI	GDI
Fonts	-	Windows Fonts
Driver	Default Driver	SPL
	Install	SPL
	Supporting OS	Windows 2000/XP(32/64bits)/Vista(32/64bits)/2003 Server(32/64bits)/2008 Server(32/64bits) / Win7 /2008 R2
		Various Linux OS: - Red Hat 8~9, - Fedora Core 1~4 - Mandrake 9.2~10.1 - SuSE 8.2~9.2 Mac OS 10.3~10.6
	WHQL	Windows 2000/XP(32/64bits)/Vista(32/64bits)/2003 Server(32/64bits)/2008 Server(32/64bits) / Win7 /2008 R2
Compatibility	Win 2000/XP(32/64bits)/2003 Server/Vista(32/64bits),2008 Server(32/64bits)/ Win7 /2008 R2	
Wired Network	Protocol	N/A
	Supporting OS	N/A

Items		Specification
Wireless Network	Protocol	N/A
	Supporting OS	N/A
Application	Smart Panel	SmartPanel for Windows/ Macintosh/LINUX
	Printer Setting	N/A
	Network Management	N/A
	IP Setting	N/A
Interface	Parallel	N/A
	USB	Compatible with USB 2.0
	Wired Network	N/A
	Wireless Network	N/A
User Interface	LCD	N/A
	LED	2 LED
	Key	2 key

2.1.2.3 Paper Handling

Items		Specification
Standard Capacity		150-sheet Tray@80g/m ²
Max. Capacity		150 sheets @ 80g/m ²
Printing	Max. Size	216 x 356 mm (8.5" x 14")
	Min. Size	76 x 183 mm (3.0" x 7.2")
Standard Cassette Tray	Capacity	150 sheets @ 80g/m ²
	Media sizes	A4, A5, A6, ISO B5, JIS B5, Executive, Letter, O cio, Folio, Legal, Custom
	Media types	Plain, Thin, Recycled, Thick, Archive
	Media weight	16~32lb (60 to 120g/m ²)
	Sensing	Paper Empty
Optional Cassette Tray	Capacity	N/A
	Media sizes	N/A
	Media types	N/A
	Media weight	N/A
	Sensing	N/A
	Output Stacking	
Output Stacking	Face-Down	100 sheets @ 75g/m ² (Base Line Paper : Samsung Premium/ Xerox4200) NN Condition
Duplex	Supporting	N/A

2.1.2.4 Consumables

Items		Specification
Toner Cartridge	Black	Initial : Average Cartridge Yield 0.7K standard pages. Sales : Average cartridge Yield 1.5K standard pages. Declared cartridge yield in accordance with ISO/IEC 19752.
	Key	Electronic key(CRUM) Only
	Life detect	Toner gauge sensor by dot count

2.1.2.5 Maintenance part

Items	Life
Transfer roller	30K pages
Fuser unit	30K pages
Pick up roller	30K pages

2.1.2.6 Reliability & Service

Items	Specification
Printing Volume (SET AMPV)	75 sheets/month
MPBF	10,000 sheets
MTTR	30 min.
SET Life Cycle	30,000 sheets or 5 years (whichever comes first)

2.1.2.7 Environment

Items		Specification
Operating Environment	Temperature	10C to 32C
	Humidity	20% to 80%
Acoustic Noise Level(Sound Power/ Pressure)	Printing	49 dBA
	Standby	Back Ground Level
	Sleep	Back Ground Level
Power Consumption	Ready	Less than 40W
	AVG.	Less than 270W
	Max/Peak	Less than 300W
	Sleep / Power Off	Less than 2.8W / Less than 0.45W (Conformity to EPA)
Dimension (W x D x H)	SET	341 x 224 x 184 mm (13.42" x 8.81" x 7.24")
	SET Packing	394 x 278 x 241 mm (15.5" x 10.0" x 9.5")
	Toner	284 x 231.5 x 47.8mm
	Toner Packing	361 x 270 x 113 mm
Weight	SET	4.12kg
	Toner	0.68kg
	Gross	5.6kg

2.1.2.8 Packing & Accessory

Items	Life
In-Box	Driver & Network Install CD-ROM Power Cable USB Cable (CIS/China/Korea/India) Quick Install Guide Warranty Registration Card User's Manual (PDF File)

2.1.2.9 Options

Items	Specification
Memory	N/A
Second Cassette	N/A
Wired Network	N/A
Wireless Network	N/A
Hard Disk	N/A
Duplex Unit	N/A

2.1.3 Model Comparison Table

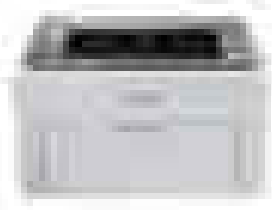
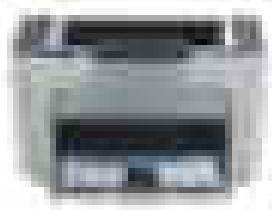
	Samsung ML- 1660	Samsung ML- 2240	HP P1505n
Image			
Speed	16 ppm (A4)	22 ppm (A4)	23 ppm (A4)
processor	150 MHz	150 MHz	266 MHz
Memory	8 MB	8 MB	32 MB
Print Language	GDI	GDI	PCL5e
Input	150 sheets Bin	150 sheets Bin	250 sheets Bin, 10 Manual
Duplex	Manual	Manual	Manual
Interface	USB 2.0	USB 2.0	USB 2.0
Size (mm)	341 x 224 x 184 mm	353 x 298 x 213 mm	379 x 243 x 225 mm
Toner	Standard 0.7K / 1K	Standard 1.5K	Standard 2K

2.2 System Overview

This chapter describes the functions and operating principal of the main component.

2.2.1 Front View

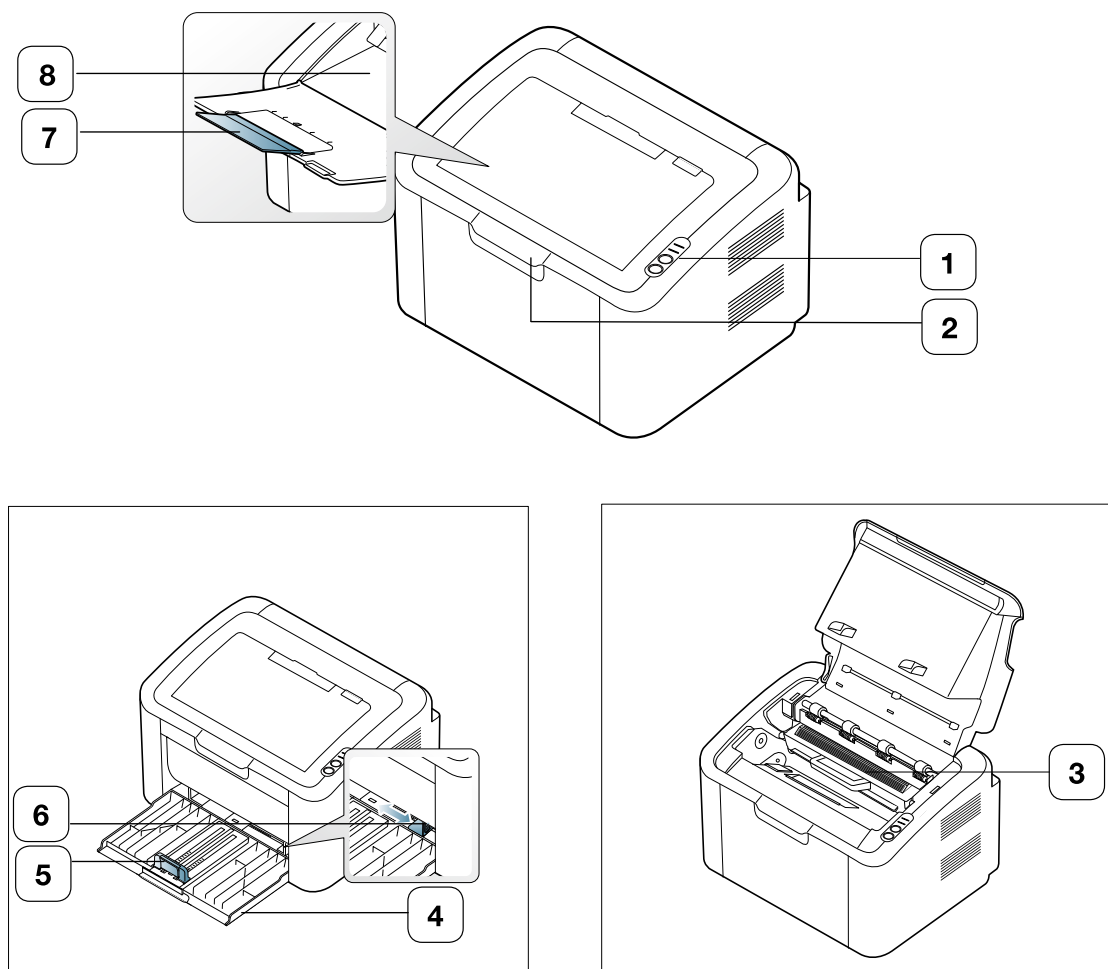

This illustration may differ from your machine depending on its model.

1	Control panel	5	Paper length guide
2	Top cover	6	Paper width guides
3	Toner cartridge	7	Output support
4	Tray	8	Output tray (face down)

2.2.2 Rear View

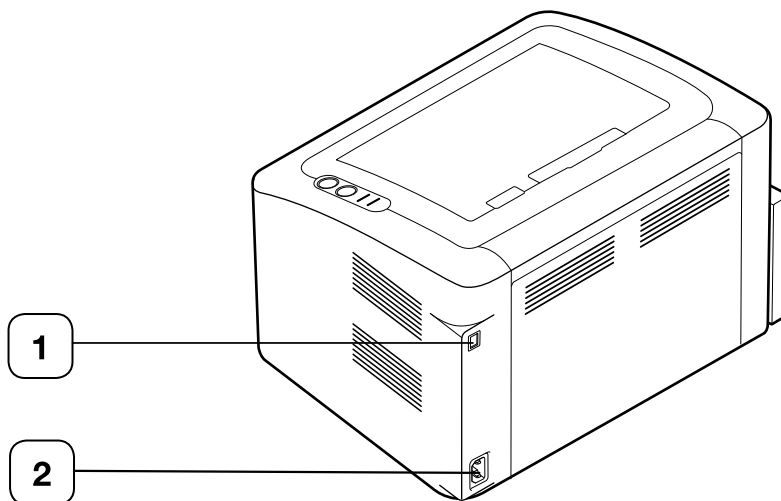

This illustration may differ from your machine depending on its model.

1	USB port	2	Power receptacle
---	----------	---	------------------

2.2.3 System Layout

This model is consisted of the Engine parts and F/W, and said engine parts is consisted of the mechanical parts comprising Frame, Feeding, Developing, Driving, Transferring, Fusing, Cabinet and H/W comprising the main control board, power board, operation panel, PC Interface.

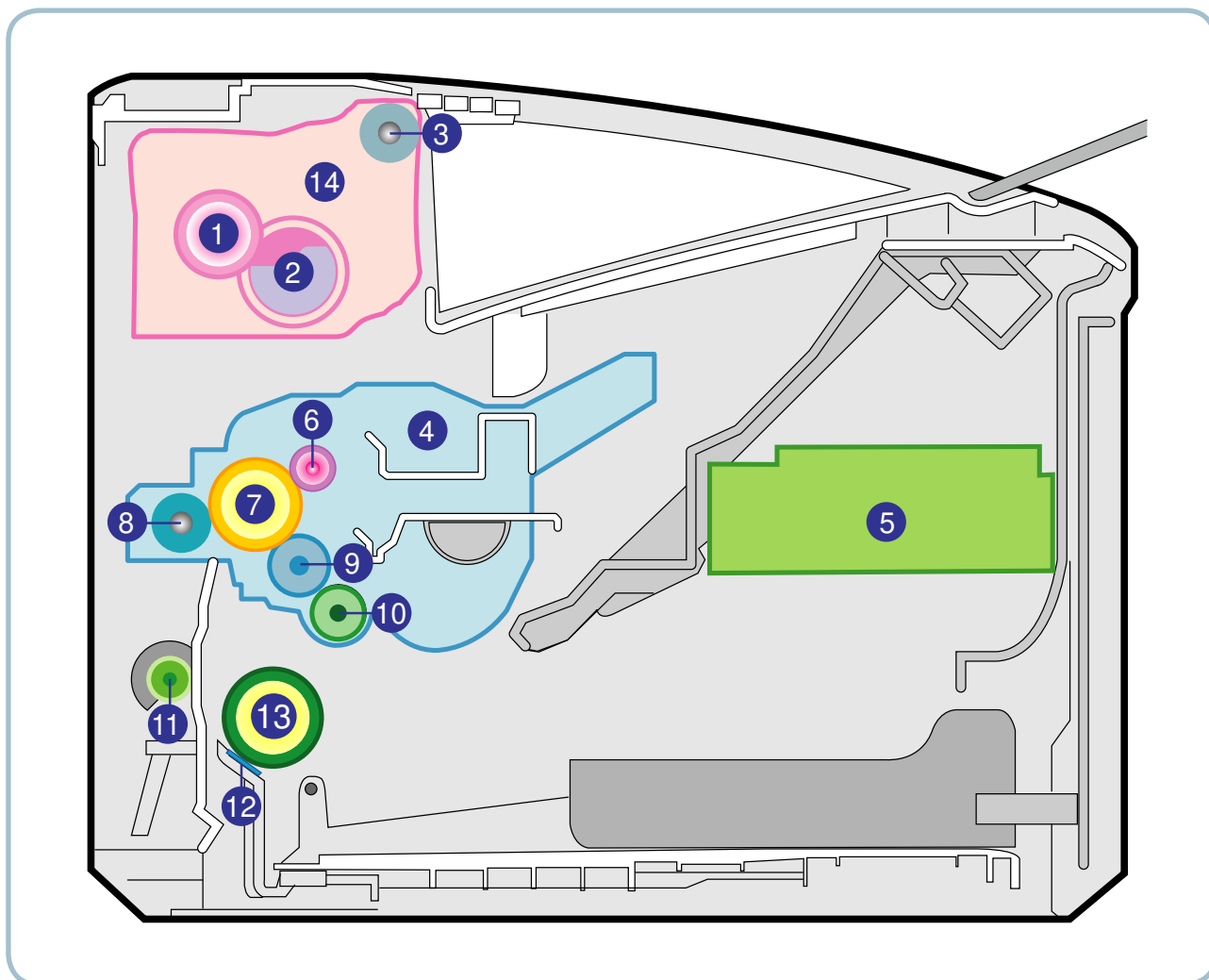

NO.	NAME
1	Pressure roller
2	Heat roller
3	Exit roller
4	Toner Cartridge
5	LSU
6	Charge roller
7	OPC

NO.	NAME
8	Transfer roller
9	Deve roller
10	Supply roller
11	Feed roller
12	Friction pad
13	Pickup roller

2.2.3.1 Feeding Part

It consists of a basic cassette, an MP tray for supplying different types of media (envelope, label, special paper) and parts related to paper transferring.

1) Separation method

Paper is separated by the friction pad mounted to the center of the cassette.

2) Input tray

This model has a bin-type tray.
It takes a center loading method and applies 'friction pad separating method.'
Both the side guide and the rear guide can be adjusted for various types of papers from A6 to legal size paper.
It has a paper existence sensing function
(Capacity: 150 sheets (80g/m² paper standard), paper arranging function, various size papers accepting function.
In the front side, there is a paper level indicator.



3) Pick-up roller

It has functions such as a paper pickup function, driving control function, paper feeding function, and removing electronic static function. Pick up roller is drive by solenoid.

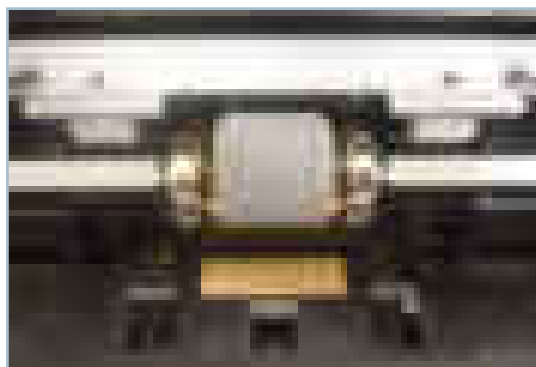

2.2.3.2 Transfer Roller

- The transfer roller delivers the toner of the OPC drum to the paper.
- There is no PTL Ass'y.
- Life Span : Print over 30,000 sheets (in15~30℃)

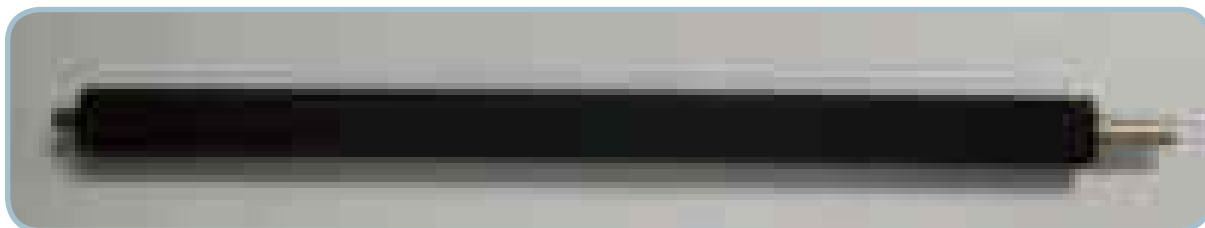

2.2.3.3 Driver Assy

- In ML-1660, the driving device is consisted of OPC, Pick- up, Feed, Fuser, Gear- Train connected with Mounting member. A step motor for driving is assembled to the left frame.
 - Driving Frequency: Step Motor 840 PPS (1050rpm)
 - It is a power delivery unit by gearing: Step Motor → Pick-up/Feeder/Transfer/Fuser/Exit



2.2.3.4 Fuser

It is consisted of a halogen lamp, heat roller, pressure roller, thermistor and thermostat. It sticks the toner on a paper by heat and pressure to complete the printing job.



1) Thermostat

When a heat lamp is overheated, a Thermostat cuts off the main power to prevent over- heating.

- Thermostat Type : Non- Contact type dual THERMOSTAT
- Control Temperature : $170^{\circ}\text{C} \pm 5^{\circ}\text{C}$

2) Thermistor

It is a temperature detecting sensor.

- Temperature Resistance : $7\text{ k}\Omega$ (180°C)

3) Heat roller

The heat roller transfers the heat from the lamp to apply a heat on the paper.

The surface of a heat roller is coated with Teflon, so toner does not stick to the surface.

4) Pressure roller

A pressure roller mounted under a heat roller is made of a silicon resin, and the surface also is coated with Teflon. When a paper passes between a heat roller and a pressure roller, toner adheres to the surface of a paper permanently.

5) Halogen Lamp

- Voltage 120 V : $115 \pm 5\%$
220 V : $230 \pm 5\%$
- Capacity : 600 Watt $\pm 25\text{ W}$

6) Items for safety

Protecting device for overheating

- 1st protection device: Hardware cuts off when overheated
- 2nd protection device: Software cuts off when overheated
- 3rd protection device: Thermostat cuts off main power.

Safety device

- A fuser power is cut off when a front cover is opened
- Maintain a temperature of fuser cover's surface under 80(C for user, and attach a caution label at where customer can see easily when customer open a rear cover.

2.2.3.5 LSU (Laser Scanner Unit)

It is the core part of the LBP which switches from the video data received to the controller to the electrostatic latent image on the OPC drum by controlling laser beam, exposing OPC drum, and turning principle of polygon mirror. The OPC drum is turned with the paper feeding speed. The /HSYNC signal is created when the laser beam from LSU reaches the end of the polygon mirror, and the signal is sent to the controller. The controller detects the /HSYNC signal to adjust the vertical line of the image on paper. In other words, after the /HSYNC signal is detected, the image data is sent to the LSU to adjust the left margin on paper. The one side of the polygon mirror is one line for scanning.

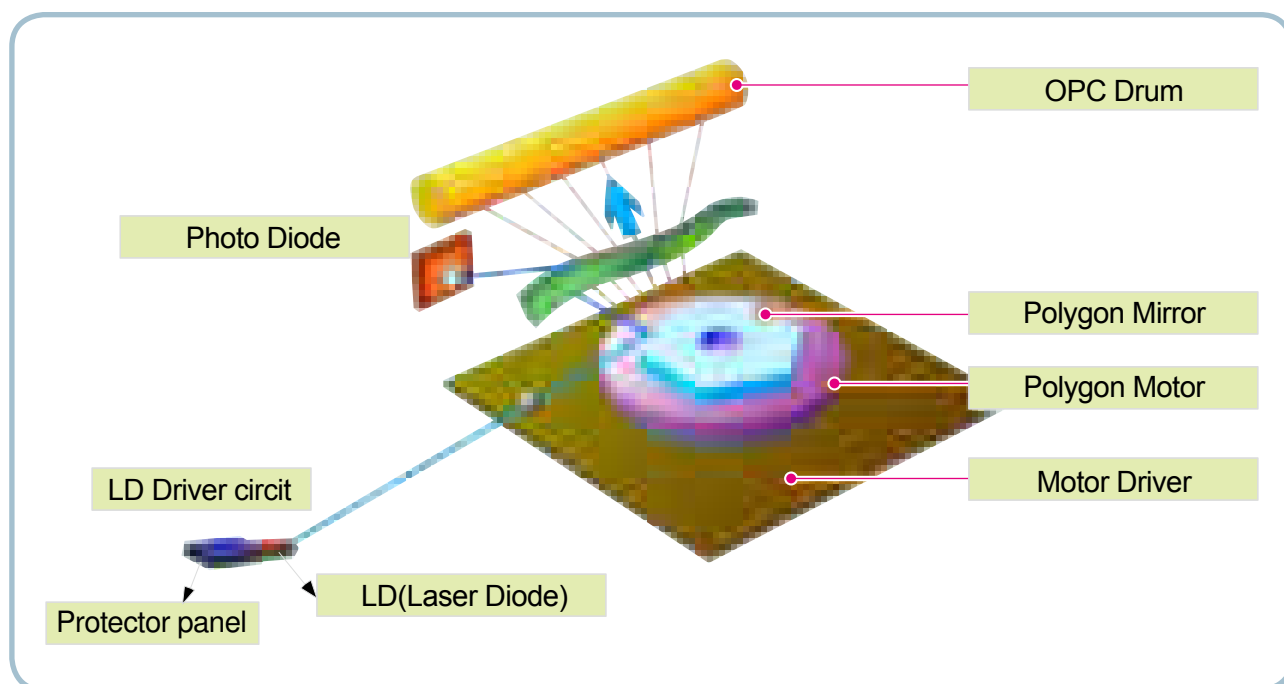

2.2.3.6 Toner Cartridge

By using the electronic photo process, it creates a visual image. In the toner cartridge, the OPC unit and the developing unit are in a body. The OPC unit has OPC drum and charging roller, and the toner cartridge unit has toner, supply roller, developing roller, and blade (Doctor blade)

- Developing Method : Non magnetic 1 element contacting method
- Toner : Non magnetic 1 element shatter type toner
- Charging capacity : $- 39.1 \pm 3 \mu\text{C/g}$
- Average OD : $8.0 \pm 0.5 \mu\text{m}$ (Toner)
- The life span of toner (ISO 19752 pattern / A4 standard)
 - Initial toner : 0.7K
 - Sales toner : 1.5K
- Toner Residual Sensor : Dot count with CRUM(CRU Monitor)
- OPC Cleaning : Collect the toner by using cleaning blade
- Handling of wasted toner : Collect the wasted toner in the cleaning frame by using cleaning blade
- OPC Drum Protecting Shutter : None
- Classifying device for toner cartridge: ID is classified by CRUM.

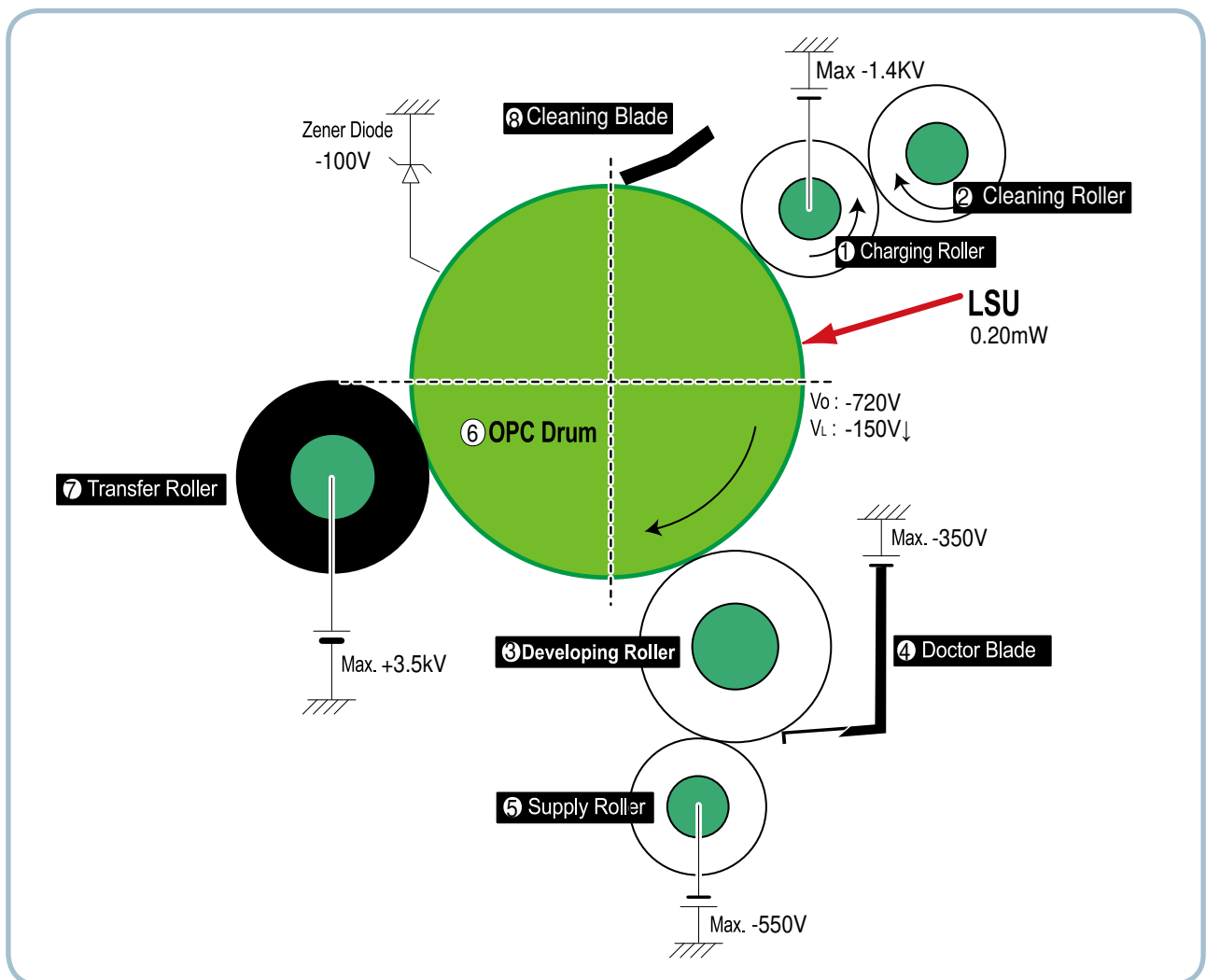

2.2.4 Engine H/W Specifications

2.2.4.1 Main PBA

The Engine Board and the Controller Board are in one united board, and it is consisted of CPU part and print part in functional aspect. The CPU is functioned as the bus control, I/O handling, drivers, and PC interface. The main board sends the Current Image of Video data to the LSU and manages the conduct of Electrophotography for printing. It is consisted of the circuits of the motor (paper feed, pass) driving, clutch driving, pre-transfer lamp driving, current driving.

The signals from the paper feed jam sensor and paper empty sensor are directly inputted to the main board.

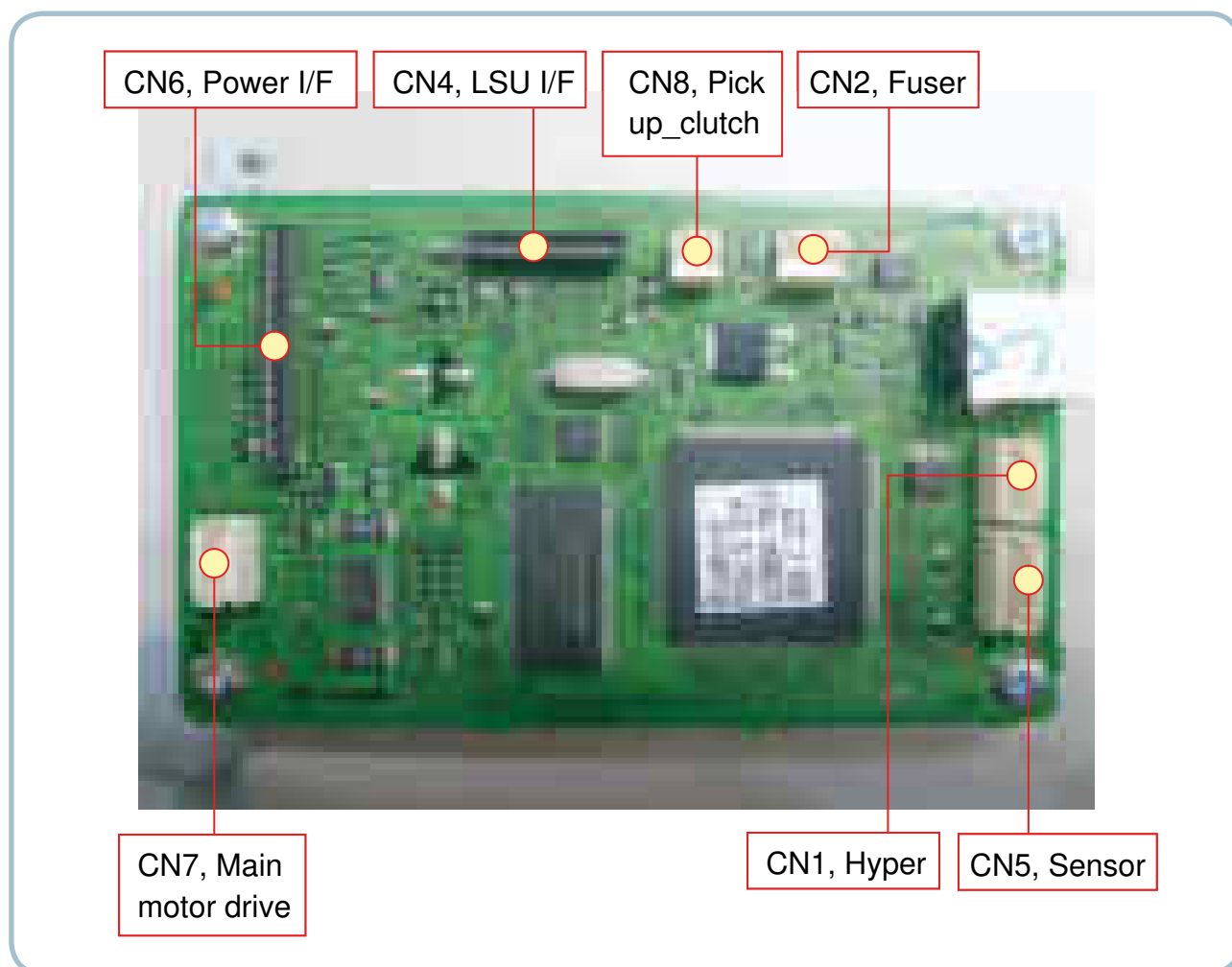

(a) Asic(Jupiter4e)

- CPU Core : Use 32Bit RISC Processor of Jupiter4e, and control system by operating Operation Block of the System Program inside Flash Memory.
- Main Function Block:
 - ▶ Completely Integrated System for Embedded Applications,
 - ▶ 32 Bit Risc Architecture, Efficient and Powerful ARM9 CPU
 - ▶ LSU Interface Module for Interfacing PVC with LSU
 - ▶ 2 Channel General Purpose DMA Controller for High Speed I/O
 - ▶ Dual Memory Bus Architecture
 - Operation Frequency : 150MHz
 - Operation Voltage : 3.3V
 - POWER ON RESET TIME : 6.6ms below

(b) Memory

1) Flash Memory

- Store System Program and can be download System Program through PC Interface
- Capacity : 0.5M Byte
- Access Time : 70 nsec

2) SDRAM

- When Printing, use Band Buffer, System Working Memory Area .
- 8M capa : 8M Byte basic.
 - 8M :Printing System Working Memory Area
- Access Time : 60 nsec

(c) Sensor Input Circuit

■ Paper Empty Sensing

The Paper empty sensor on the tray detects the state of paper empty and the state of paper width i.e. narrow paper width or not.

■ Regi Sensing

N/A

■ Paper Feeding

When paper passes the actuator (feed sensor part), it detects the signal of Photo interrupter, informs the paper feeding state to CPU, and then sprays the image data after certain time.

If it doesn't detect the feed sensor within 1sec. after paper is fed, paper Jam0 is occurred (LED will be display Orange color).

■ Paper Exit Sensing

N/A

■ Cover Open Sensing

The Cover open sensor is located on the HVPS. After the top cover is opened, +24VS (Solenoid, Main Motor, Polygon motor part of LSU and HVPS), which is supplied to the each unit, is cut off.

In case, the red will be ON for informing the facts to user.

■ SOLENOID Driving

Clutches are driven by turning on TRs, which is controlled by CPU. The diode in the Clutch driving circuits protects TR driven from the noise pulse, which is occurred when the solenoid is de-energized.

■ Motor Driving

The main motor driving circuits is on the main board

There is motor driver IC on the main board control the step motor.

2.2.4.2 HVPS and SMPS Board

The HVPS Board and SMPS Board are in one united board.

The HVPS board creates the high voltage of THV/MHV/Supply/Dev and supplies it to the developer part for making best condition to display the image. The HVPS part takes the 24V and outputs the high voltage for THV/MHV/BIAS, and the outputted high voltage is supplied to the toner, OPC cartridge, and transfer roller

It is the power source of entire system. It is assembled by an independent module, so it is possible to use for common use. It is mounted at the side of the set.

It is consisted of the SMPS part, which supplies the DC power for driving the system, and the AC heater control part, which supplies the power to fuser. SMPS has two output channels. Which are +3.3V and +24V.

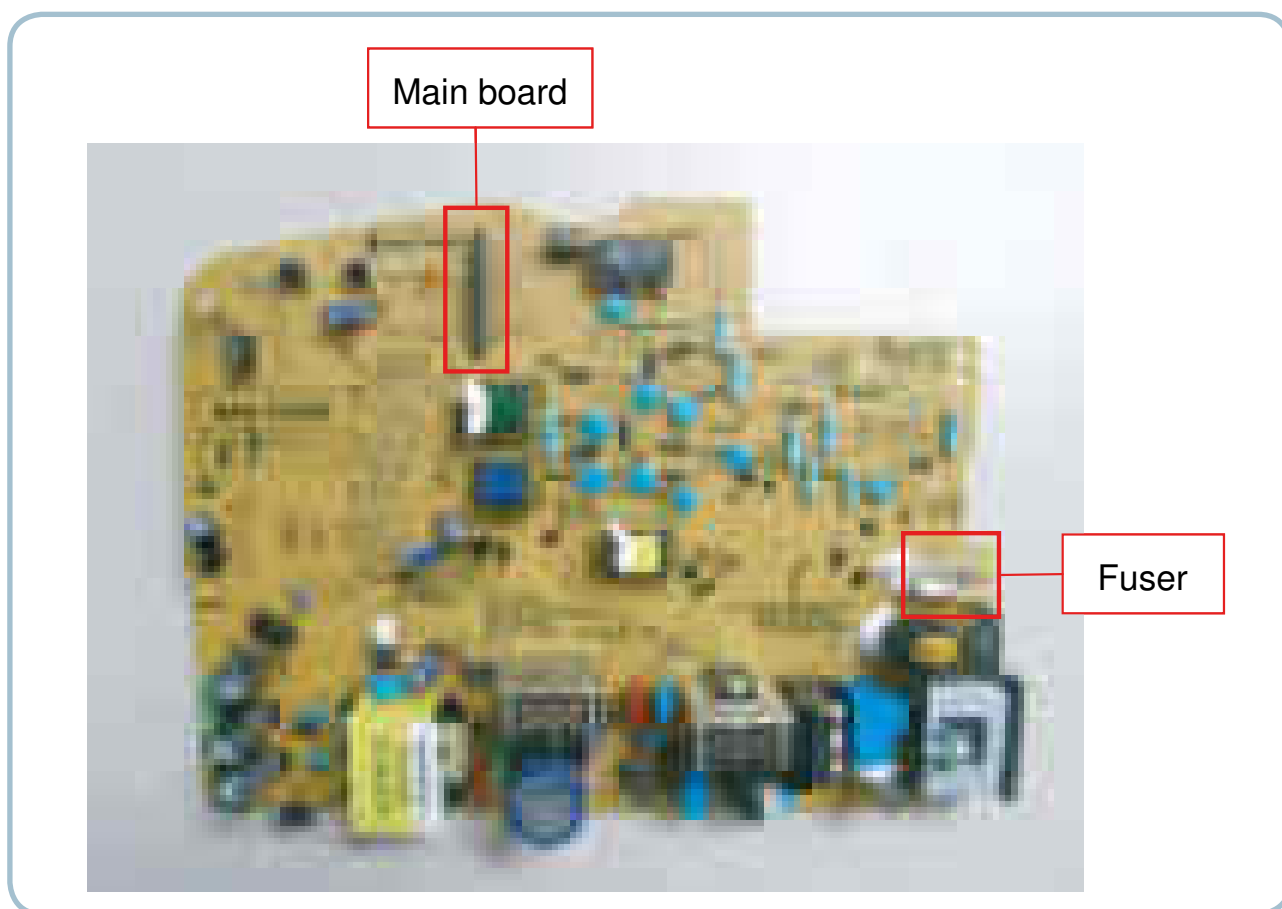

■ HVPS Board

• Transfer High Voltage (THV+)

- Input Voltage : 24 V DC \pm 15%
- Output Voltage : THV+: max +3.5kV \pm 10 %,(Duty Variable, no loading)
THV-: -1kV \pm 20% (when cleaning,200 M Ω)
- Input contrast of the Voltage stability degree : under \pm 3 % (fluctuating input 21.6V~26.4V)
Loading contrast : \pm 3 % or less
- Output Voltage Rising Time : 50 ms Max
- Output Voltage Falling Time : 100 ms Max
- Fluctuating transfer voltage with environmental various : 0~3.5kV
- Environment Recognition Control Method : The THV-PWM ACTIVE is transfer active signal. It detects the resistance by recognizing the voltage value, F/B, while permits the environmental recognition voltage.
- Output Voltage Control Method : Transfer Output Voltage is outputted and controlled by changing Duty of THVPWM Signal.

• Charge Voltage (MHV)

- Input Voltage : 24 V DC \pm 15%
- Output Voltage : -1.0KV ~ -1.8KV DC \pm 3%
- Output Voltage Rising Time : 50 ms Max
- Output Voltage Falling Time : 50 ms Max
- Output Loading range : 30 M Ω ~ 1000 M Ω
- Output Control Signal(MHV-PWM) : CPU is HV output when PWM is Low

• Cleaning Voltage (THV-)

- The (+) Transfer Voltage is not outputted because the THV PWM is controlled with low.
- The (-) Transfer Voltage is outputted because the THV-Enable Signal is controlled with low
- The output fluctuation range is big because there is no Feedback control.

• Developing Voltage (DEV)

- Input Voltage : 24 V DC \pm 15%
- Output Voltage: -200V ~ -500V DC \pm 3%
- Output Voltage Fluctuation range: PWM Control
- Input contrast of the output stability degree : \pm 3 % or less
Loading contrast : \pm 3 % or less
- Output Voltage Rising Time : 50 ms Max
- Output Voltage Falling Time : 50 ms Max
- Output Loading range : 10M Ω ~ 1000 M Ω
- Output Control Signal (BIAS-PWM) : the CPU output is HV output when PWM is low.

• Supply

- Output Voltage : -350 V ~ -650V DC \pm 50 V(ZENER using, DEV)
- Input contrast of the output stability degree : under \pm 5 %
Loading contrast : \pm 5 % or less
- Output Voltage Rising Time : 50 ms Max
- Output Voltage Falling Time : 50 ms Max
- Output Loading range : 10 M Ω ~ 1000 M Ω
- Output Control Signal (BIAS-PWM) : the CPU is HV output when PWM is low.

■ SMPS Board

• AC Input

- Input Rated Voltage : AC 220V ~ 240V AC 110V ~ 127V
- Input Voltage fluctuating range : AC 180V ~ 270V AC 90V ~ 135V
- Rated Frequency : 50/60 Hz
- Frequency Fluctuating range : 47 ~ 63 Hz
- Input Current : Under 4.0Arms / 2.0Arms (But, the status when Fuser is off or rated voltage is inputted/ outputted)

• Rated Output Power

NO	ITEM	CH1	CH2	Remark
1	CHANNEL NAME	+3.3V	+24.0V	
2	CONNECTOR PIN	CON 3 3.3V PIN: 5,7 GND PIN: 8,9	CON 3 24V PIN:1,2,3 GND PIN:8,9,25,26	
3	Rated Output	+3.3V±5% (3.135~3.465V)	+24V±10% -> -10%, +15%, (21.6~26.4V) -> 27.6V	
4	Max. Output Current	0.8A	1.35A	
5	Peak Loading Current	1.0A	1.8A	100ms
6	RIPPLE NOISE Voltage	100mVp-p	Under 500mVp-p	
7	Maximum output	2.64W	32.4W	
8	Peak output	3.3W	43.2W	100ms
9	Protection for loading shortage and overflowing current	Shut down or Fuse Protection	Shut down or Output Voltage Drop	

2.2.5 Engine F/W Contol Algorithm

2.2.5.1 Feeding

If feeding from a cassette, the drive of the pickup roller is controlled by controlling the solenoid. The on/off of the solenoid is controlled by controlling the general output port or the external output port. While paper moves, occurrence of Jam is judged as below.

Item	Description
JAM 0	<ul style="list-style-type: none"> - After picking up, paper cannot be entered due to paper is not fed. - After picking up, paper entered but it cannot reach to the feed sensor in certain time due to slip, etc. - After picking up, if the feed sensor is not on, re-pick up. After re-picking up, if the feed sensor is not on after certain time, it is JAM 0. * <i>It is a status that the leading edge of the paper doesn't pass the feed sensor.</i> - Even though the paper reaches to the feed sensor, the feed sensor doesn't be ON. * <i>It is a status that the leading edge of the paper already passes the feed sensor.</i>
JAM 1	<ul style="list-style-type: none"> - After the leading edge of the paper passes the feed sensor, the trailing edge of the paper cannot pass the feed sensor after a certain time. (The feed sensor cannot be OFF)

2.2.5.2 Transfer

The charging voltage, developing voltage and the transfer voltage are controlled by PWM (Pulse Width Modulation). The each output voltage is changeable due to the PWM duty. The transfer voltage admitted when the paper passes the transfer roller is decided by environment recognition. The resistance value of the transfer roller is changed due to the surrounding environment or the environment of the set, and the voltage value, which changes due to the environments, is changed through AD converter. The voltage value for impressing to the transfer roller is decided by the changed value.

2.2.5.3 Fusing

The temperature change of the heat roller's surface is changed to the resistance value through the thermistor. By converting the voltage value, which impressed to the resistance, to the digital value through the AD converter, the temperature is decided. The AC power is controller by comparing the target temperature to the value from the thermistor. If the value from the thermistor is out of controlling range while controlling the fusing, the error stated in the below table occurs.

- **Open Heat Error**

When the engine operates the warm-up process, if the temperature of the fixing unit is not higher than a specified temperature, the engine defines Open Heat Error. When this error is broken out, the engine stops all functions and keeps the error state. Also, the engine informs the error status of the main system. And then the error message is displayed at LCD window or LED informing the error status of the user.

- **Low Heat Error**

When the engine is at stand-by, printing or warm-up mode, if the temperature of the fixing unit is lower than the specified temperature at each state and the lower temperature state is maintained during the specified time, the engine defines Low Heat Error. When this error is broken out, the engine stops all functions and keeps it at the error state. Also the engine informs the error status of the main system. And then the error message is displayed at LCD window or LED informing the error status of the user.

- **Over Heat Error**

For overall engine state, if the temperature of the fixing unit is higher than the specified temperature and the temperature state is kept during the specified time, the engine defines Over Heat Error. When this error is broken out, the engine stops all functions and keeps it at the error state. Also, the engine informs the error status of the main system. And then the error message is displayed at LCD window or LED to inform the error status of the user.

2.2.5.4 LSU

LSU receives the image data from PVC or HPVC and make the latent image on OPC surface. It uses the single beam, LD.

The errors related to LSU are as follows:

- **By LReady** : When the printing is started, the engine drives the polygon motor of LSU. After the specified time is elapsed, if the motor is not in a ready status, the engine detects the error that the polygon motor is not in a ready status. If this error happens, the engine stops all functions and keeps it at the error state. Also, the engine informs the error status of the main system and the error message is displayed at LCD window to inform the error status of the user.
- **By Hsync** : When the polygon motor is ready, the LSU sends out the signal called Hsync and used to synchronize with each image line. So, if the engine does not detect consecutively the signal for a fixed time, it defines the Hsync Error. If this error happens, the engine stops all functions and keeps it at the error state. Also, the engine informs the error status of the main system and then the error message is displayed at LCD window to inform the error status of the user.
 LSU Error Recovery: If the LReady or Hsync error happens, the paper exits out beforehand. The engine mode is changed to recovery mode and the engine informs the main system of the engine mode. And the engine checks the LSU error. If the error doesn't happen, the printing job will be proceeding.

2.2.6 S/W Descriptions

2.2.6.1 Overview

The software of ML-1660 system is constructed with

- 1) Host Software part that the application software operated in Window and Web Environment, and
- 2) Firmware parts that is a Embedded software controls printing job.

2.2.6.2 Architecture

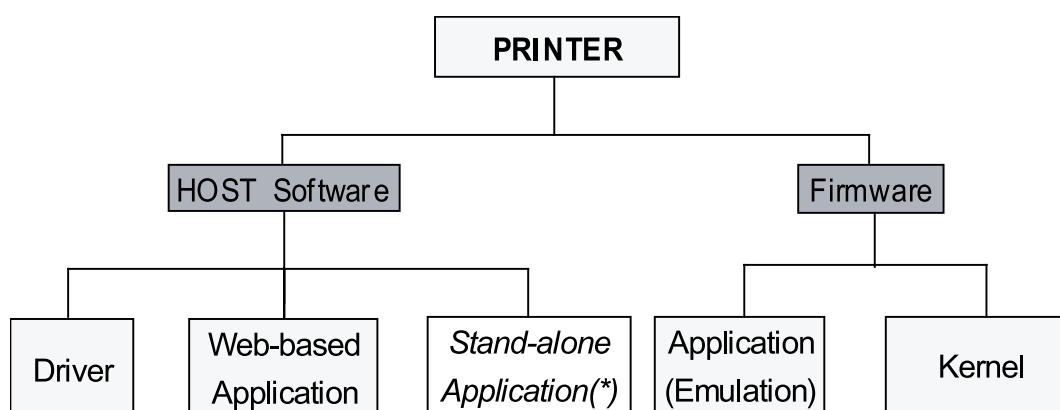

☞ (*) is job for common S/W team

Host Software is made up of

1. Graphic User Interface that offers the various editing functions to user in Host,
2. Driver that translates the received document to a Printing Command language which printer can understand and transfers data to spooler,
3. Stand-alone Application that offers the various printing application, PSU(Printer Settings Utility), Printer Status Monitor, Network Management in Window system,
4. Web-based-Application that offers the same functions as Stand-alone Application and RDC(Remote Diagnosis Control) in Web environment.

Firmware is made up of

1. Application (Emulation) that is a interpreter translate data received from Host to a printing language (PCL, PS, GDI, etc.) to be able to make the user to take same output as originally one what composed in Host.
2. Kernel that control and management the whole procedure include of Control flow and Printing Job before transfer to Engine system.

2.2.6.3 Data and Control Flow

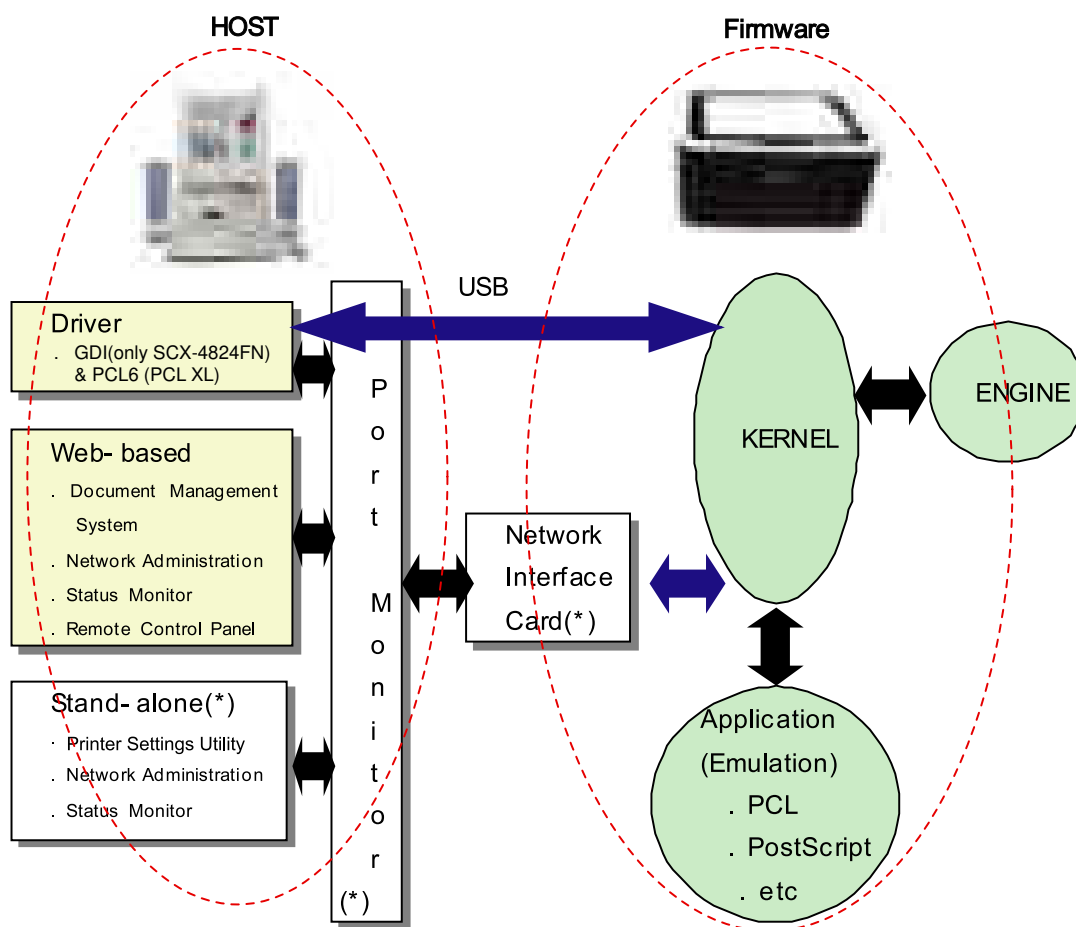

Note: (*) is role of N/W I/F

The above Block Diagram is explained that:

Host Side is made up of

1. Driver that is Windows application software translate printed data to one of printer language and create spooler file.
2. Web-based Application that offer a various printer additional functions, management of printing job, printer administration, Status monitor to monitoring the printer status by real time in Web, independent environment on OS.
3. Stand-alone Application that is a similar Window software as same as above 2,
4. Port Monitor that manages the network communication between spooler and Network Interface Card, or various additional application and Network Interface Card,(this is, at first, make communication logical port, manage the data, transfer them from spooler to network port, and offer the result of printing).

Firmware Side is made up of

1. Network Interface Card is that relay the communication between Host and kernel using various network protocol.
2. Kernel is that manages the flow control of emulation procedure, receiving data from Host or Network card and printing with engine & rendering job,
3. Emulation is that interprets the various output data from selected emulation,
4. Engine is that prints rendered bit-map data to paper with required size and type by Kernel.

And then, for Job Spooling function for Multi-User, Multi-Printing that is occurred in Network printing and various additional printing functions, this Kernel use max. 10 Queuing systems in a memory.

In Printing, the two procedures are**(1) Case of using USB Port**

- After user start to print the wanted document to PCL string or compressed GDI bit-map data, Driver translate the all graphic data of it and send data to host spooler. And then the spooler sends the data stream to the printer via USB port.
- Kernel receives this data from Host, and then select emulation fit to data and start selected one. After emulation job end, Kernel sends the output bit-map data to Engine using Printer Video Controller (by clock type for LSU).
- Engine print the received data to required paper with the sequential developing process.

(2) Case of using Network Interface Card

- After user start to print the wanted document to PCL string or compressed GDI bit-map data, Driver translate the all graphic data of it and send data to host spooler.
- If so, Port monitor managing network port receives data from spooler and sends a data stream to the Network Interface Card.
- Network interface card receives it and send to Kernel part.
- Kernel receives this data from Host, and then select emulation fit to data and start selected one. After emulation job end, Kernel sends the output bit-map data to Engine using Printer Video Controller (by clock type for LSU).
- Engine print the received data to required paper with the sequential developing process.

The additional printing function are realized in

- (1) Web environment
- (2) Window environment.

On addition, Kernel informs a status of printing status and printer status to user made printing job with the Status Monitor.

3. Disassembly and Reassembly

3.1 Precautions when replacing parts

3.1.1 Precautions when assembling and disassembling

- * Use only approved Samsung spare parts. Ensure that part number, product name, any voltage, current or temperature rating are correct. Failure to do so could result in damage to the machine, circuit overload, fire or electric shock.
- * Do not make any unauthorized changes or additions to the printer, these could cause the printer to malfunction and create electric shock or fire hazards.
- * Take care when dismantling the unit to note where each screw goes. There are 19 different screws. Use of the wrong screw could lead to system failure, short circuit or electric shock.
- * Do not disassemble the LSU unit. Once it is disassembled dust is admitted to the mirror chamber and will seriously degrade print quality. There are no serviceable parts inside.
- * Regularly check the condition of the power cord, plug and socket. Bad contacts could lead to overheating and fire. Damaged cables could lead to electric shock or unit malfunction.

3.1.2 Precautions when handling PBA

Static electricity can damage a PBA, always use approved anti-static precautions when handling or storing a PBA.

>> Precautions when moving and storing PBA

1. Please keep PBA in a conductive case, anti-static bag, or wrapped in aluminum foil.
2. Do not store a PBA where it is exposed to direct sunlight.

>> Precautions when replacing PBA

1. Disconnect power connectors first, before disconnecting other cables
2. Do not touch any soldered connections, connector terminals or other electronic parts when handling insulated parts.

>> Precautions when checking PBA

1. Before touching a PBA, please touch other grounded areas of the chassis to discharge any static electrical charge on the body.
2. Take care not to touch the PBA with your bare hands or metal objects as you could create a short circuit or get an electric shock. Take extra care when handling PBAs with moving parts fitted such as sensors, motors or lamps as they may get hot.
3. Take care when fitting, or removing, screws. Look out for hidden screws. Always ensure that the correct screw is used and always ensure that when toothed washers are removed they are refitted in their original positions.

3.1.3 Releasing Plastic Latches

Many of the parts are held in place with plastic latches. The latches break easily; release them carefully.

To remove such parts, press the hook end of the latch away from the part to which it is latched.

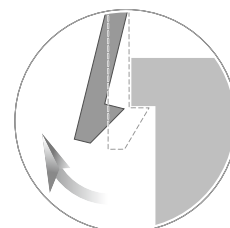

3.2 Screws used in the printer

The screws listed in the table below are used in this printer. Please ensure that, when you disassemble the printer, you keep a note of which screw is used for which part and that, when reassembling the printer, the correct screws are used in the appropriate places.

Part Code	Location	Description	Qty
6003-000196	FRAME	SCREW-TAPTYPE;PWH,+ ,B,M3,L10,NI PLT,SWRCH18A	8
6003-000269		SCREW-TAPTYPE;BH,+ ,-,S,M3,L6,ZPC(WHT),SWRCH18A,-	20
6003-000282		SCREW-TAPTYPE;BH,+ ,-,B,M3,L8,ZPC(BLK),SWRCH18A,-	5
6003-000282	FUSER	SCREW-TAPTYPE;BH,+ ,-,B,M3,L8,ZPC(BLK),SWRCH18A,-	3
6006-001078		SCREW-TAPTYPE;PH,+ ,WSP,B,M3,L10,ZPC(WHT),SWRCH18A	1
6003-000196	FUSER-UPPER	SCREW-TAPTYPE;PWH,+ ,B,M3,L10,NI PLT,SWRCH18A	1
6003-000282		SCREW-TAPTYPE;BH,+ ,-,B,M3,L8,ZPC(BLK),SWRCH18A,-	4
6003-000269	FUSER -LOWER	SCREW-TAPTYPE;BH,+ ,-,S,M3,L6,ZPC(WHT),SWRCH18A,-	3
6003-000196	FRAME-PAPER PATH	SCREW-TAPTYPE;PWH,+ ,B,M3,L10,NI PLT,SWRCH18A	7
6003-000282	FRAME-FEED IDLE	SCREW-TAPTYPE;BH,+ ,-,B,M3,L8,ZPC(BLK),SWRCH18A,-	2
6003-000269	FRMAE MAIN-LEFT	SCREW-TAPTYPE;BH,+ ,-,S,M3,L6,ZPC(WHT),SWRCH18A,-	6
6003-000282		SCREW-TAPTYPE;BH,+ ,-,B,M3,L8,ZPC(BLK),SWRCH18A,-	2
6003-000269	FRMAE MAIN-RIGHT	SCREW-TAPTYPE;BH,+ ,-,S,M3,L6,ZPC(WHT),SWRCH18A,-	2
6003-000269	FRAME MAIN-MIDDLE	SCREW-TAPTYPE;BH,+ ,-,S,M3,L6,ZPC(WHT),SWRCH18A,-	5
6003-000282	LSU	SCREW-TAPTYPE;BH,+ ,-,B,M3,L8,ZPC(BLK),SWRCH18A,-	5
6003-000282	COVER-TOP	SCREW-TAPTYPE;BH,+ ,-,B,M3,L8,ZPC(BLK),SWRCH18A,-	1
6003-000282	CARTRIDGE-TONER	SCREW-TAPTYPE;BH,+ ,-,B,M3,L8,ZPC(BLK),SWRCH18A,-	4
6003-000269	MAIN LINE	SCREW-TAPTYPE;BH,+ ,-,S,M3,L6,ZPC(WHT),SWRCH18A,-	8
6003-000282		SCREW-TAPTYPE;BH,+ ,-,B,M3,L8,ZPC(BLK),SWRCH18A,-	2

3.3 Cover

3.3.1 Left/Right cover

1. Take off the left cover by removing hooks from its edge.



2. Take off the right cover by removing hooks from its edge.

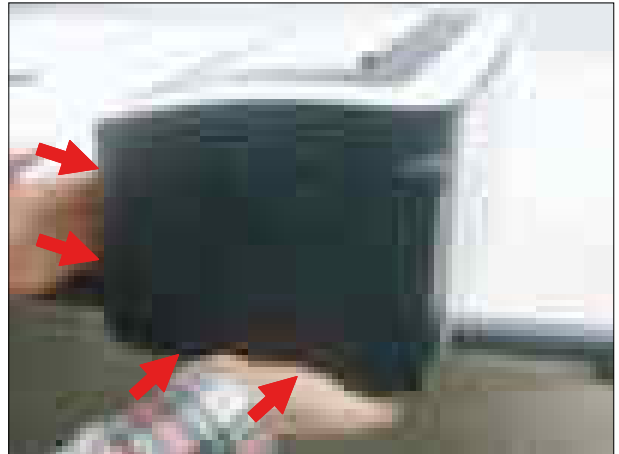

3.3.2 Rear bracket

1. Remove 4 screws. Release the rear bracket.

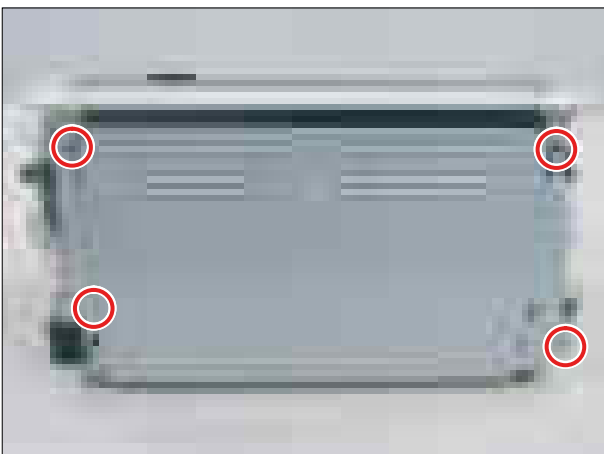

3.3.3 Cover-open

1. Release the cover-open from the hook of both sides.

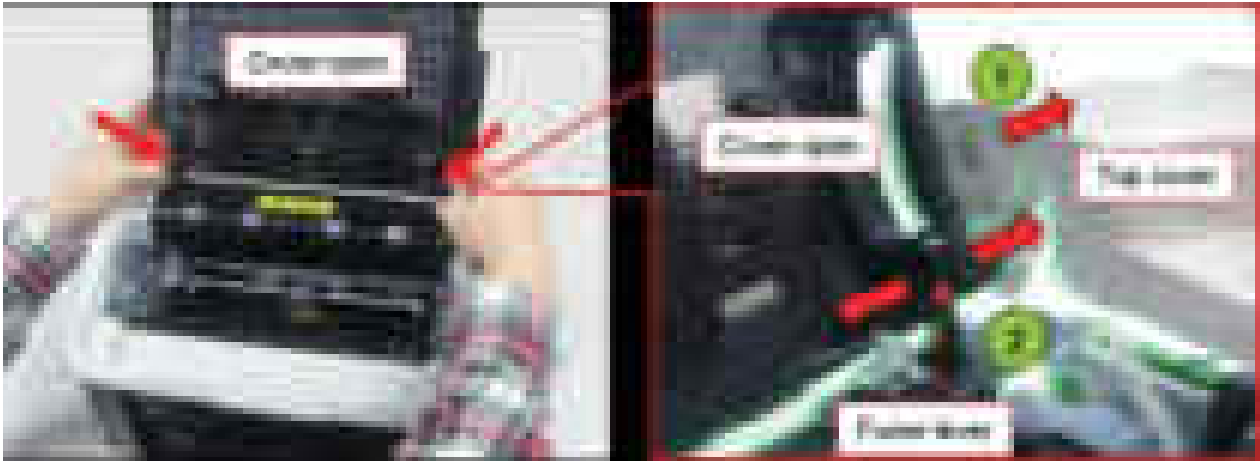

3.3.4 Top/Front cover

1. Remove 2 screws. Hold the top and front cover and pull both of them to the direction of arrow.
2. Separate the top and front cover.



3.4 Main PBA

1. To remove the main PBA, first remove the right cover. (Refer to 3.3.1)
2. Remove 4 screws. Unplug all connectors. And release the Main PBA.

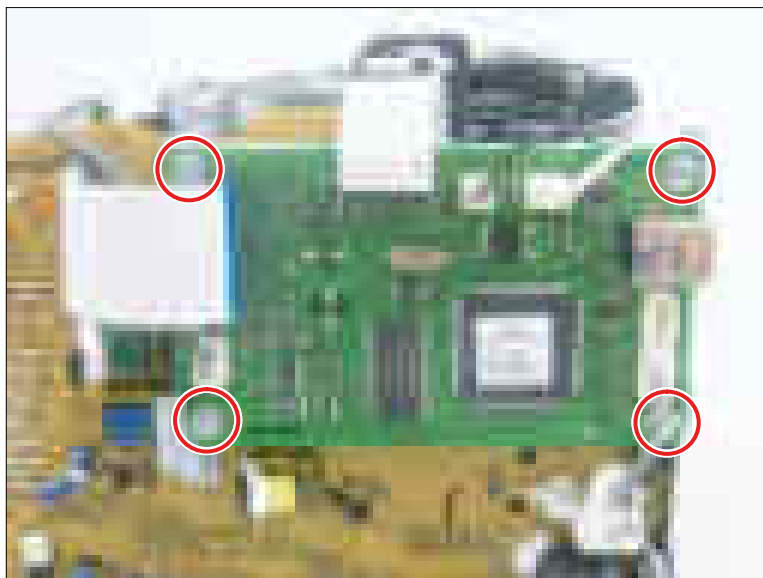

3.5 SMPS/HVPS board

1. To remove the SMPS/HVPS board, first remove the right cover and rear bracket. (Refer to 3.3)
2. Remove 4 screws. Unplug all connectors. And release the main-PBA bracket.

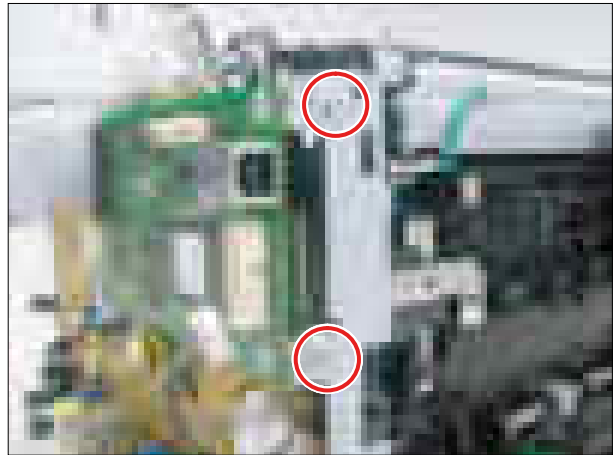
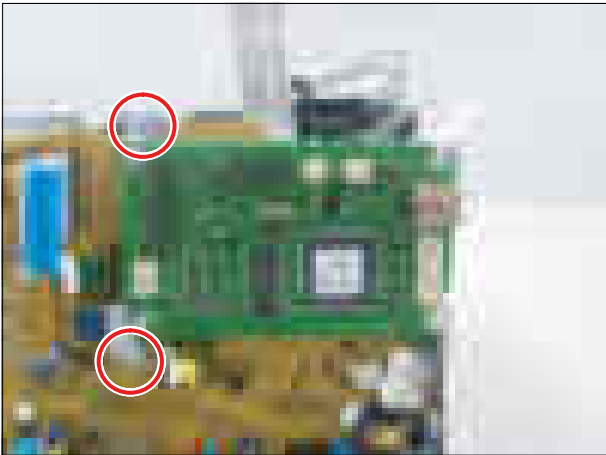

3. Remove 8 screws. Unplug a connector. And release the SMPS/HVPS board.

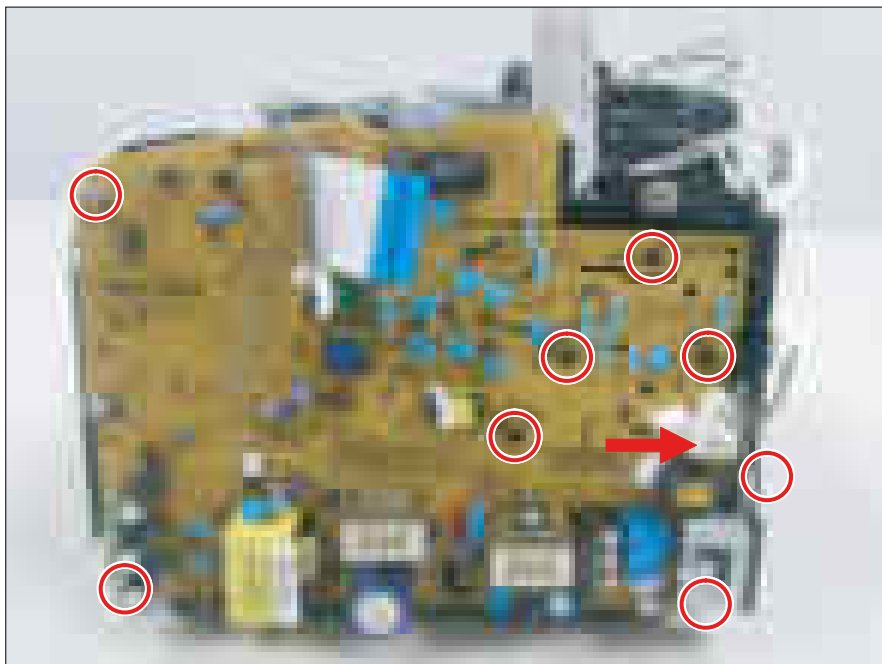

3.6 Fuser unit

1. Remove the main PBA bracket. (Refer to 3.5)
2. Unplug the connector on SMPS/HVPS board.

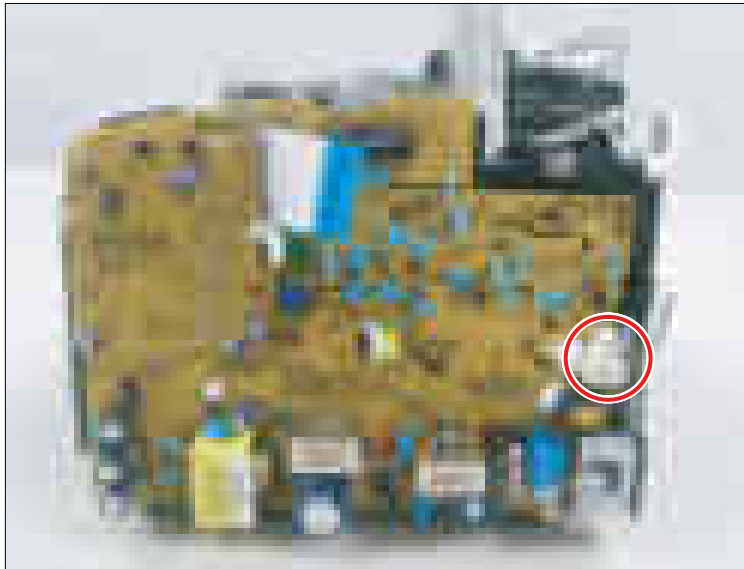

3. Remove 3 screws.
4. Pull the fuser unit to the direction of arrow slightly and release it.

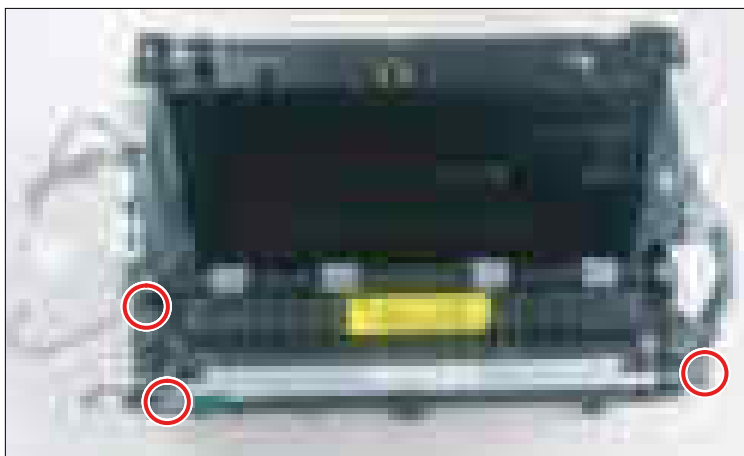

3.7 LSU

1. Remove the front/ top/ rear cover. (refer to 3.3 cover)
2. Remove 4 screw securing the COVER-LSU. Release the COVER-LSU.

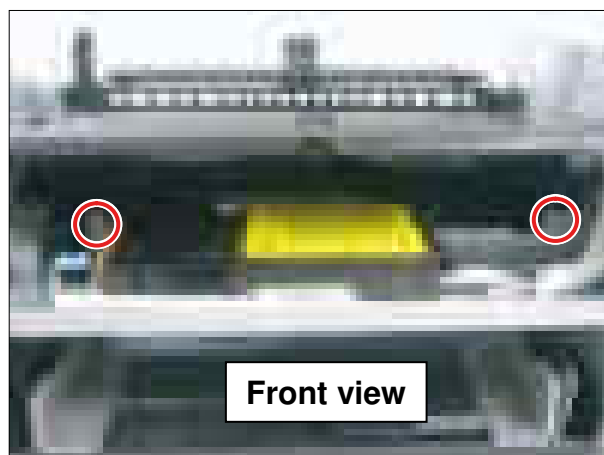

3. Remove 3 screws. Release the LSU.

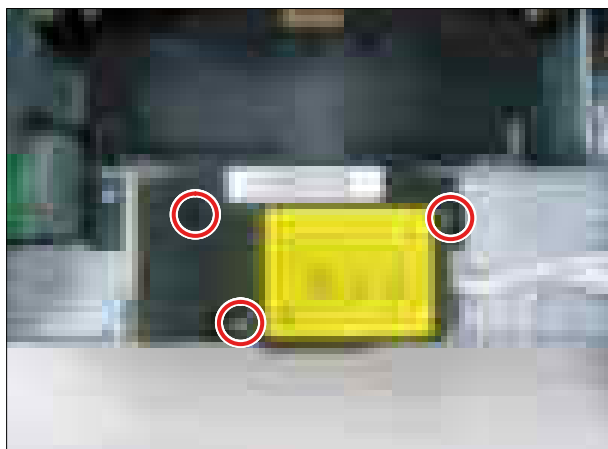

3.8 Drive unit

1. Remove the left cover.
2. Remove 4 screws. Release the drive unit.



3.9 Step motor

1. Remove the drive unit. (Refer to 3.8)
2. Remove 7 screws. Release the left-frame bracket.



Caution

When reassembling the drive unit, put down the drive unit and assemble the left-frame bracket.



3. Remove 2 screws. Release the step motor.



3.10 Pick up roller

1. Open the top cover.
2. Take out the toner cartridge.
3. Push the hinge to the direction of arrow.

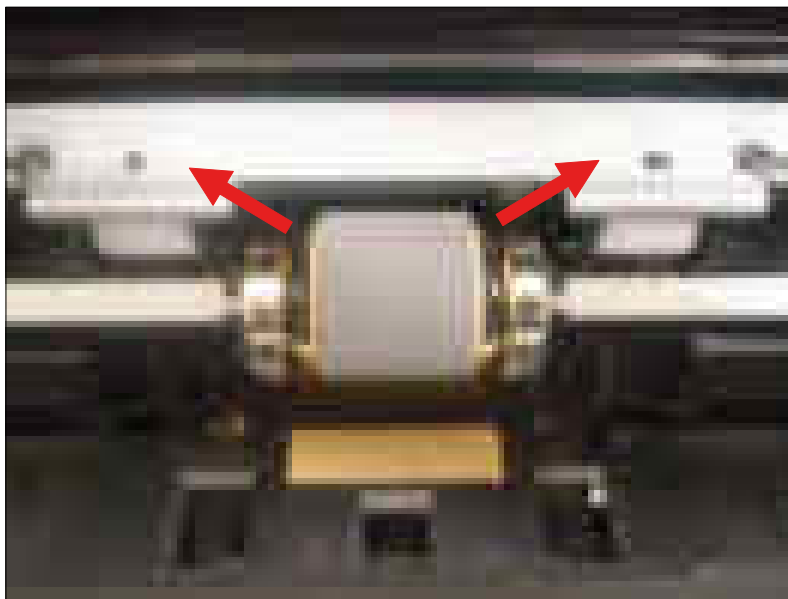

4. Alignment and Troubleshooting

4.1 Alignment and Adjustments

This chapter describes the main functions for service, such as the product maintenance method, the test output related to maintenance and repair, Jam removing method, and so on. It includes the contents of manual.

4.1.1 Control Panel

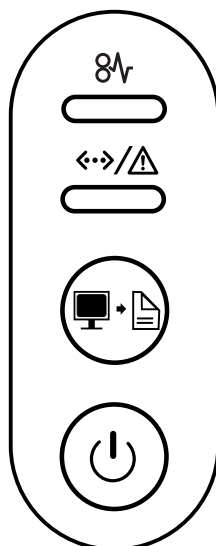

The ML-1660 series printers have 2 keys and 2 LEDs. The 'User Interface' module handles the processing of the 'Key Press' and 'LED control' at different states of the machine.



1		Jam	Shows the status of jam occurrence of your machine.
2		Online/ Error	Shows the status of your machine.
3		Print Screen	Prints the displayed screen in the monitor.
4		Power	You can turn the power on and off with this button.

4.1.2 Understanding The Control Panel

The color of the LEDs indicates the machine's current status.

LED	STATUS		DESCRIPTION
Jam 	Orange	On	A paper jam has occurred.
Online/ Error 	Off		<ul style="list-style-type: none"> The machine is off-line.
	Green	On	<ul style="list-style-type: none"> The machine is in power saver mode. The machine is on-line and can receive data from the computer.
		Blinking	<ul style="list-style-type: none"> When the LED slowly blinks, the machine is receiving data from the computer. When the LED rapidly blinks, the machine is printing data.
	Red	On	<ul style="list-style-type: none"> The cover is opened. Close the cover. There is no paper in the tray. Load paper in the tray. The machine has stopped due to a major error. Your system has some problems. If this problem occurs, contact your service representative. A toner cartridge has almost reached its estimated cartridge life^a.
Blinking		<ul style="list-style-type: none"> A minor error has occurred and the machine is waiting for the error to be cleared. When the problem is cleared, the machine resumes printing. Small amount of toner is left in the cartridge. The estimated cartridge life of toner is close. Prepare a new cartridge for replacement. You may temporarily increase the printing quality by redistributing the toner. The machine is printing in manual feed mode or in manual duplex mode. The machine is canceling a print job. 	

4.1.3 JAM Removal

4.1.3.1 Clearing Paper Jams

If a paper jam occurs, the \mathcal{L} LED on the control panel lights orange. Find and remove the jammed paper. To resume printing after clearing paper jams, you must open and close the top cover.

In tray

1. If the output tray is opened, close the output tray first.
2. Open and close the top cover. The jammed paper is automatically ejected from the machine. Make sure to open the output tray before paper ejects from the machine. If the paper does not exit, go to the next step.
3. Remove the original jammed paper by gently pulling it straight out.

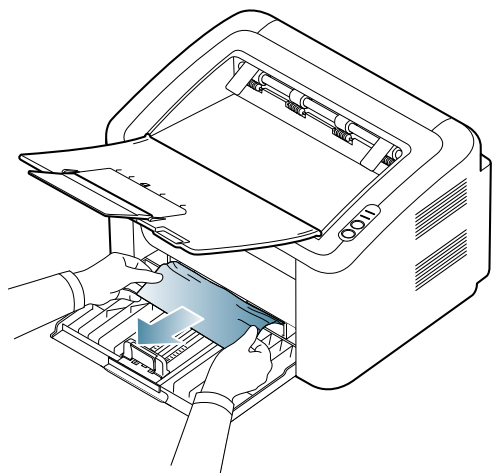

If the paper does not move when you pull, or if you do not see the paper in this area, check the fuser area around the toner cartridge.

Inside the machine

1. If the output tray is opened, close the output tray first.
2. Open and close the top cover. The jammed paper is automatically ejected from the machine. Make sure to open the output tray before paper ejects from the machine. If the paper does not exit, go to the next step.
3. Close the output tray and open the top cover.
4. Open the fuser unit cover.

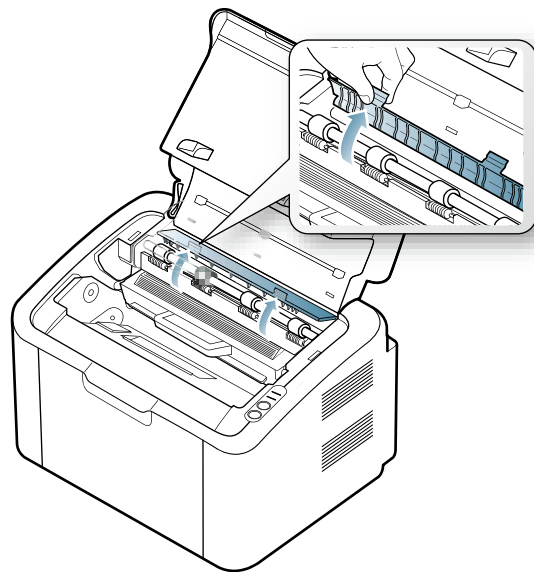

If you do not see the jammed paper, go to next step.

5. Remove the original jammed paper by gently pulling it straight out.

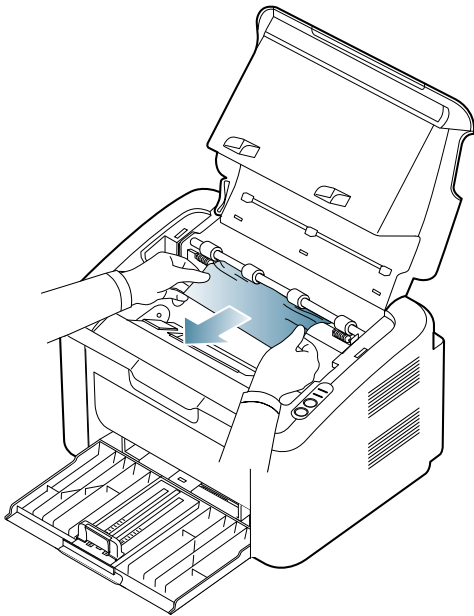

If you do not see the jammed paper, go to next step.

6. Pull the toner cartridge out.

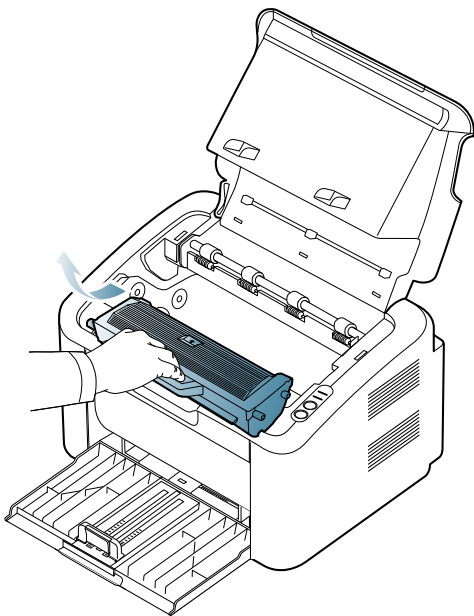

7. Remove the original jammed paper by gently pulling it straight out.

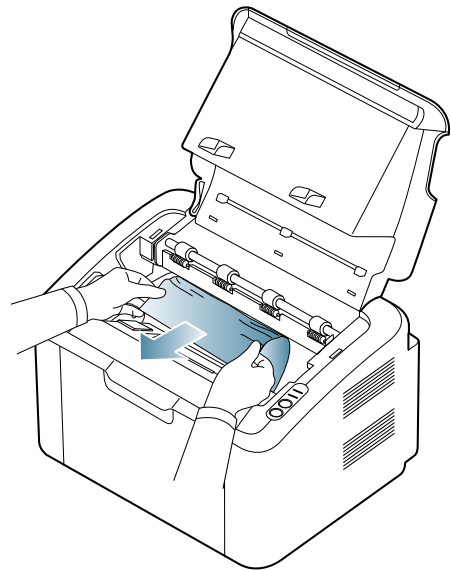

8. Replace the toner cartridge.

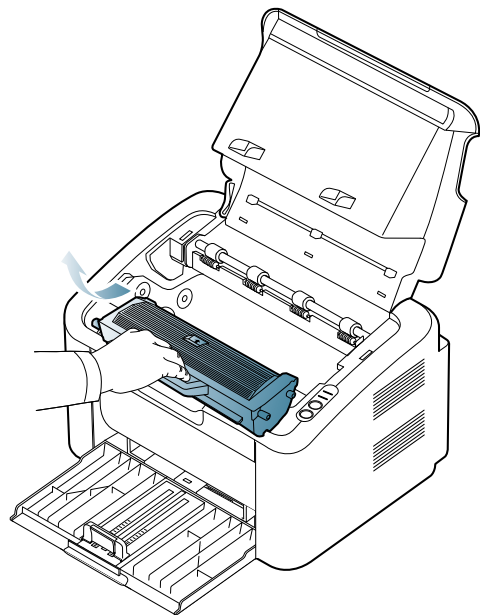

9. Close the fuser unit cover.
10. Close the top cover and open the output tray. Printing automatically resumes.

4.1.4 Printing a report

This product provides several printable reports for maintenance purposes. These reports can be used to aid the diagnosis of print quality problems.

By pressing the Print screen button, you can print these reports.

Report	How to print
Printing demo page & configuration sheet	In the ready mode, press and hold this button for about 6 seconds until the green LED blinks slowly, and release.
Supplies info report	In the ready mode, press and hold this button for about 10 seconds until the green LED blinks rapidly, and release.

■ Demo Page



■ Supplies Information Report



4.1.5 Periodic Defective Image

If an image defects appears at regular intervals on the printed-paper, it is due to a faulty or damaged roller. Refer to the table below and check the condition of the appropriate roller.

Roller	Period (mm)	Phenomenon	Defective part
OPC Drum	62.9mm	White and Black Spots	Toner Cartridge
Developing Roller	35.1mm	White spot, Horizontal black band	
Charging Roller	26.7mm	Black Spot and line and periodic band	
Supply Roller	47mm	Periodic Band by little difference of density	
Transfer Roller	39.2mm	Ghost, Damaged image by abnormal transfer	Transfer roller
Pressure Roller	75.4mm	Background	Fuser
Fusing Roller	77.5mm	Black spot and image ghost	

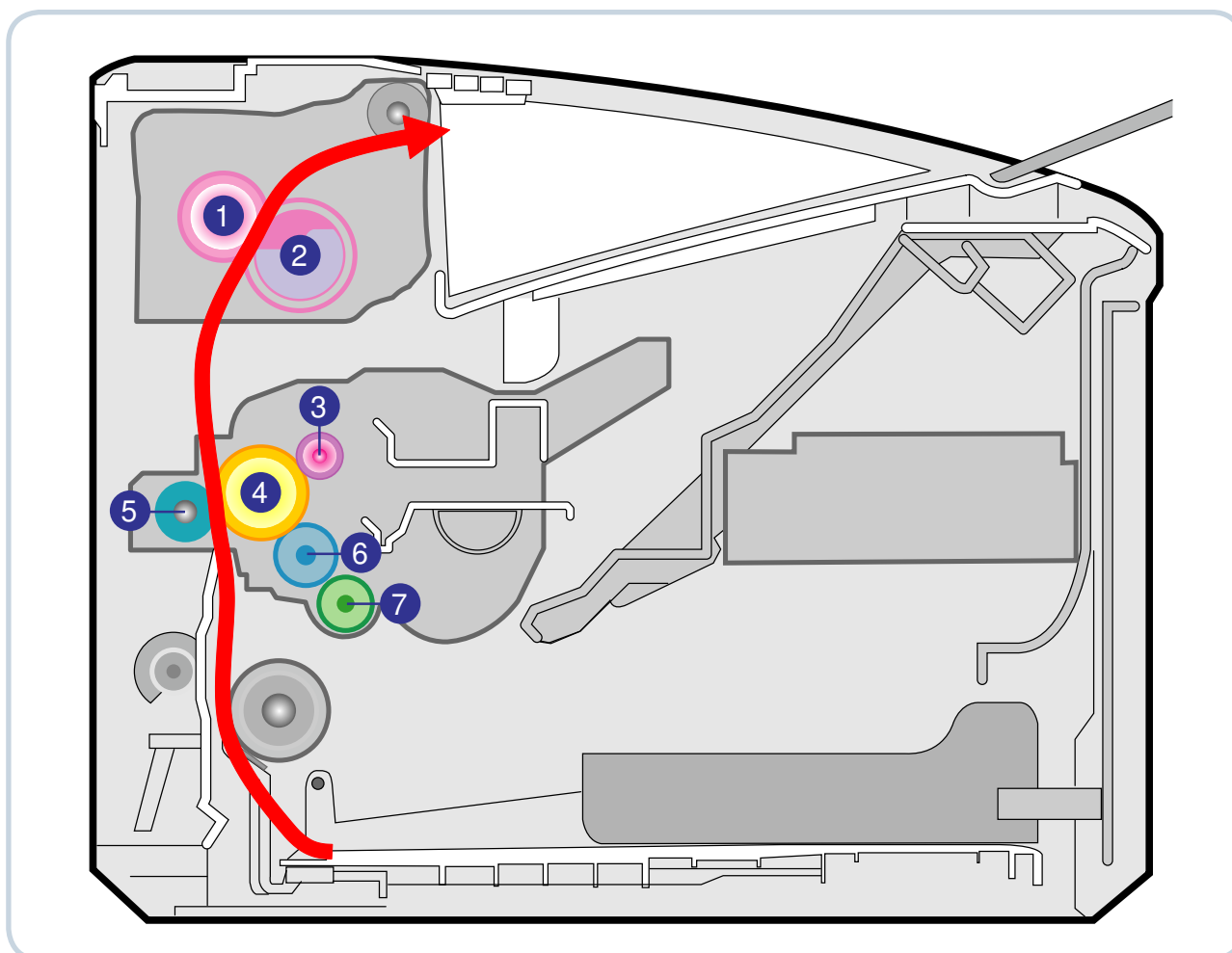

1	Pressure roller	5	Transfer roller
2	Heat roller	6	Deve roller
3	Charge roller	7	Supply roller
4	OPC		

4.1.6 Firmware upgrade

- 1) Connect PC and printer with USB cable.
- 2) Turn on the power of printer.(Ready Status)
- 3) Drag the f/w file and Drop down on the usblast2.exe. And then f/w update will be started automatically.
- 4) Please wait until end reboot.

4.1.7 Using the smart panel program

Smart Panel is a program that monitors and informs you of the machine status, and allows you to customize the machine's settings. Smart Panel is installed automatically when you install the machine software.

To use this program, you need the following system requirements:

- Windows. Check for windows operating system(s) compatible with your machine.
- Mac OS X 10.3 or higher
- Linux. Check for Linux systems that are compatible with your machine.
- Internet Explorer version 5.0 or higher for flash animation in HTML Help.

If you need to know the exact model name of your machine, you can check the supplied software CD.

4.1.7.1 Understanding Smart Panel

If an error occurs while printing, you can check the error from the Smart Panel.

You can also launch Smart Panel manually. Double-click the Smart Panel icon on the Windows task bar (in Windows), or Notification Area (in Linux).

You can also click it on the status bar (in Mac OS X).

Windows	Double-click this icon in Windows.
Macintosh	Click this icon in Mac OS X.
Linux	Click this icon in Linux.

Or, if you are a Windows user, you can launch it from the Start menu, select Programs or All Programs > Samsung Printers > your printer driver name > Smart Panel.

- If you have already installed more than one Samsung machine, first select the correct machine model you want in order to access the corresponding Smart Panel.
Right-click (in Windows or Linux) or click (in Mac OS X) the Smart Panel icon and select your machine.
- The Smart Panel window and its contents shown in this user's guide may differ depending on the machine or operating system in use.

The Smart Panel program displays the current status of the machine, the level of toner remaining in the toner cartridge(s), and various other types of information. You can also change settings.

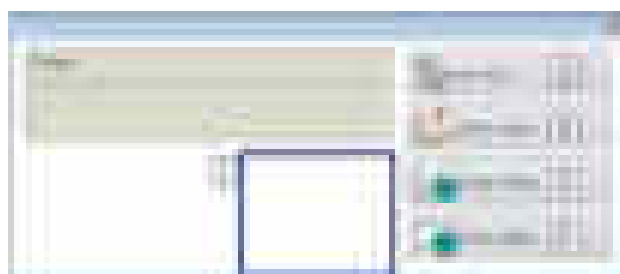

1	Toner Level	View the level of toner remaining in the toner cartridge(s). The machine and the number of toner cartridge(s) shown in the above window may differ depending on the machine in use. Some machines do not have this feature.
2	Buy Now	Order replacement toner cartridge(s) online.
3	User's Guide	View User's Guide. This button changes to Troubleshooting Guide when error occurs. You can directly open troubleshooting section in the user's guide.
4	Printer Setting	Configure various machine settings in the Printer Settings Utility window. Some machines do not have this feature. If you connect your machine to a network, the SyncThru™ Web Service window appears instead of the Printer Settings Utility window.
5	Driver Setting	Set all of the machine options you need in the Printer Preferences window. This feature is available only for Windows.

4.1.7.2 Opening the Troubleshooting Guide

Find solutions for problems by using the Troubleshooting Guide.
Right-click (in Windows or Linux) or click (in Mac OS X) the Smart Panel icon and select Troubleshooting Guide.

4.1.7.3 Changing the Smart Panel Program Settings

Right-click (in Windows or Linux) or click (in Mac OS X) the Smart Panel icon and select Options. Select the settings you want from the Options window.

4.2 Troubleshooting

4.2.1 Procedure of Checking the Symptoms

Before attempting to repair the printer first obtain a detailed description of the problem from the customer.

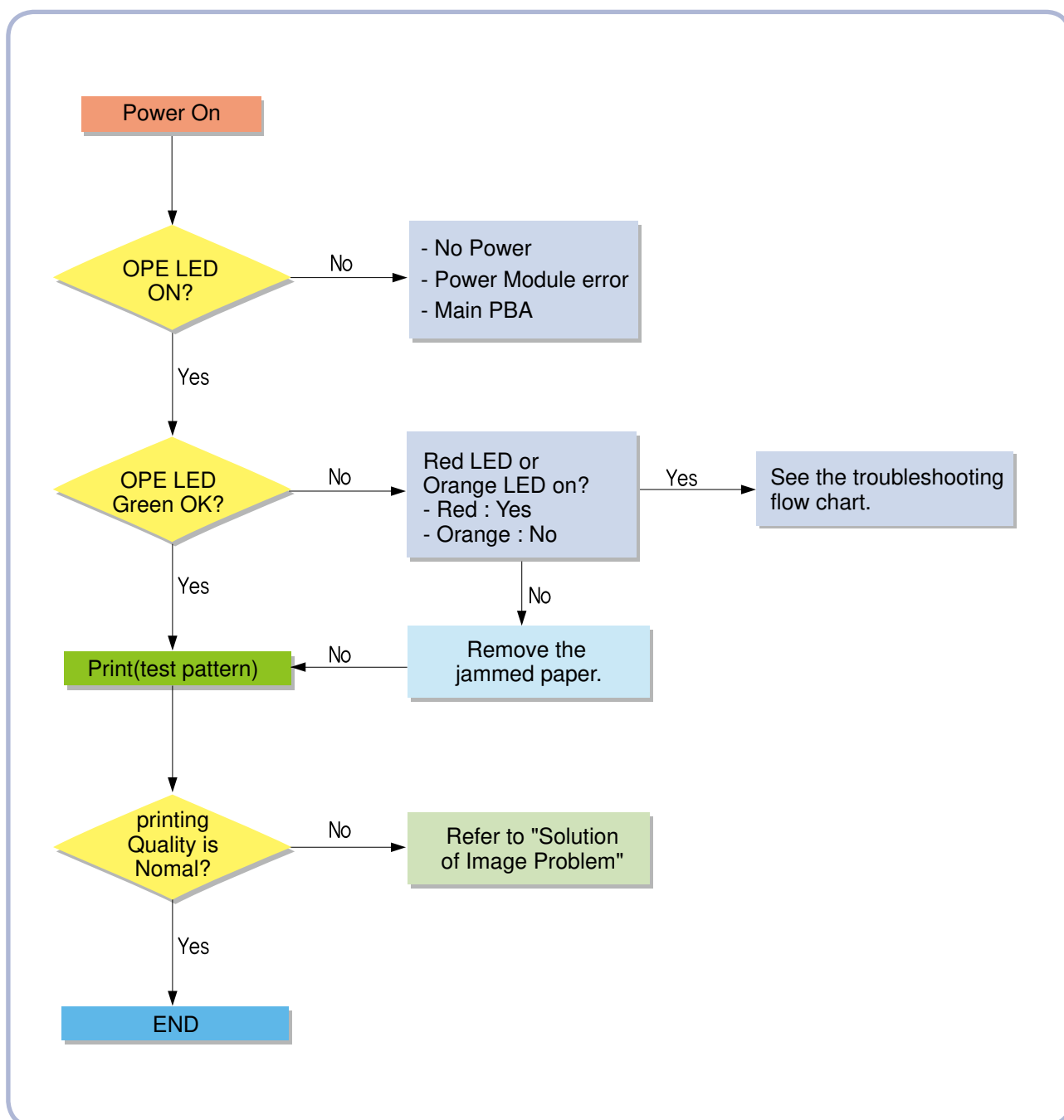

4.2.1.1 Basic Check List

1. Check the Power.

- Check that the power switch is turned on.
- Check that the power cable is plugged into the outlet and the printer.
- Check the voltage of the power outlet.

2. Check the LED of Panel.

- Is there OPE LED ON?
--> If not check power cable, switch SMPS or Main board.
- Is the abnormal Lamp?
--> Check the main PBA and cable harness.

3. Check the Paper Path

- Is there a Paper Jam?
--> Remove any paper fragments caught in the paper path.
- Paper Jam occurs repeatedly at a specific point in the Paper Path
--> Open the fuser cover, Jam clear.
--> Dismantle the machine and carefully inspect the region where the jam occurs.
(Especially, check if paper fragments are caught in the Fuser)

4. Print the Information Page (Configuration).

- Try printing a test page from a computer.
--> If there is an error check cables and driver installation.

5. Check the Print Quality.

- Is there are a Print Quality Problem?
--> Refer to section 4.2.5

6. Check consumables (toner etc.).

- Using the keys print the Test Pattern.
--> Expected life of various consumable parts, compare this with the figures printed and replace as required

4.2.1.2 Initial Inspection

1. Check Power part

1. The printer does not work no matter how long you wait.
 - A. Is the Power Switch (printer and wall socket) turned on ?
 - B. Is the Power Cord connected to the printer correctly ?
 - C. Is the Power cord connected to the wall socket correctly ?
 - D. Is wall socket working ?
 - E. Is the unit rated at the same voltage as the supply ?
2. Does the Fan work when power is turned on?
 - A. Check the connectors on the SMPS.
 - B. Check the fuses in the SMPS.(F1)

2. Check the Installation Environment.

1. Ensure the installation surface is flat, level and free from vibration.
If necessary move the printer.
2. Ensure that the temperature and humidity of the surroundings are within specification
If necessary move the printer.
3. Ensure that the printer is position away from any air conditioning or other heating or cooling equipment.
Also ensure that is not positioned in a direct draft from any air conditioning, fan or open window.
If necessary move the printer.
4. Ensure the printer is not positioned in direct sunlight.
If it is unavoidable use a curtain to shade the printer.
5. Ensure the printer is installed in a clean dust free environment.
Move the printer to clean area if necessary.
6. Some industrial or cleaning processes give of fumes which can affect the printer.
Move the printer away from this type of air pollution

3. Check paper type.

1. Use only paper which is of a suitable quality, weight and size?
See the user guide.

4. Check the overall condition of the printer

1. Is the printer properly maintained ?
Clean the Paper Transport Passages.
Any rollers with dirt surfaces should be cleaned or replaced.

4.2.2 Bad discharge

1) JAM 0

Description : 1. Paper is not exited from the cassette.
2. Jam-0 occurs if the paper feeds into the printer.

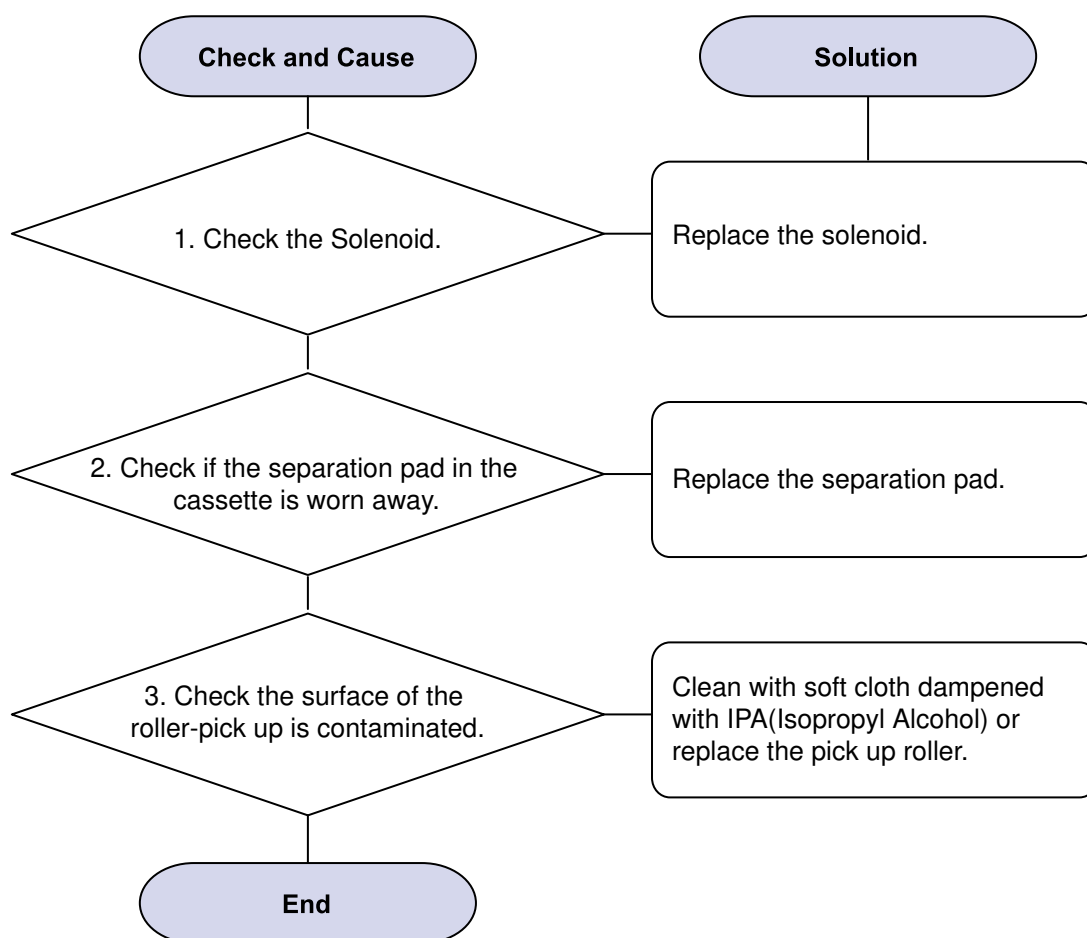

2) JAM 1

Description : 1. Recording paper is jammed in front of or inside the fuser.
 2. Recording paper is stuck in the discharge roller and in the fuser just after passing through the Actuator-Feed.

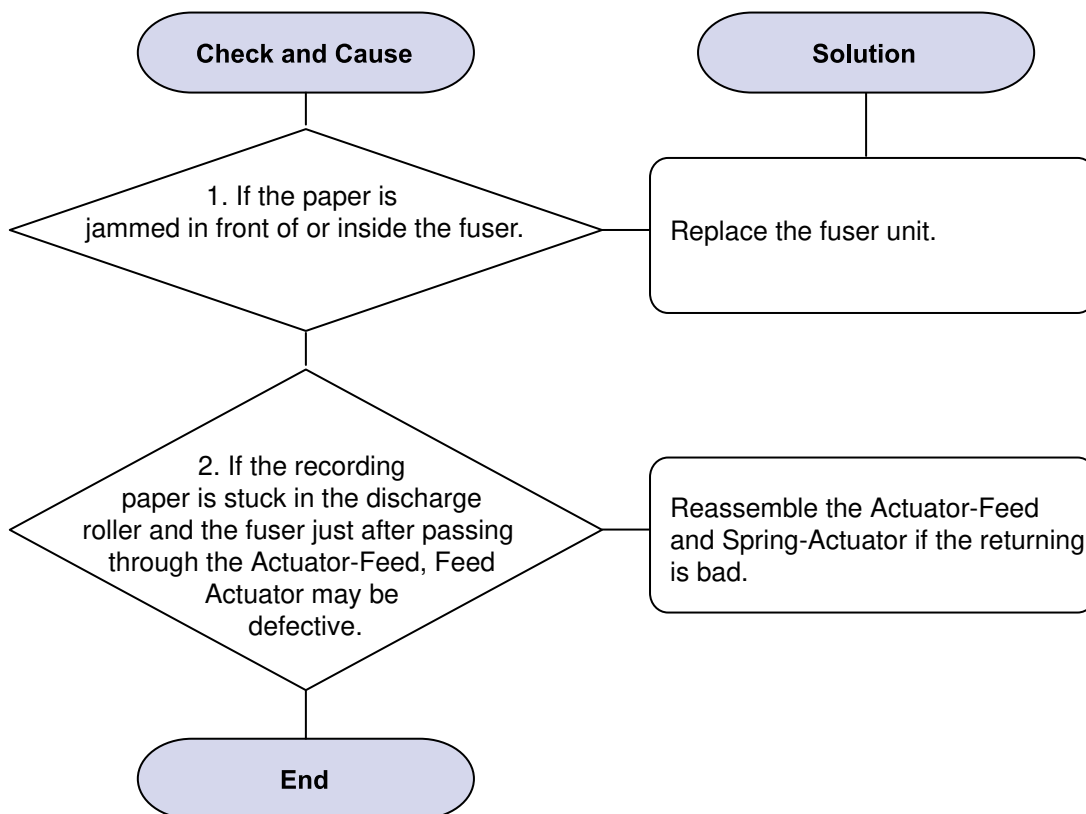

3) Multi-Feeding

Description : Multiple sheets of paper are fed at once.

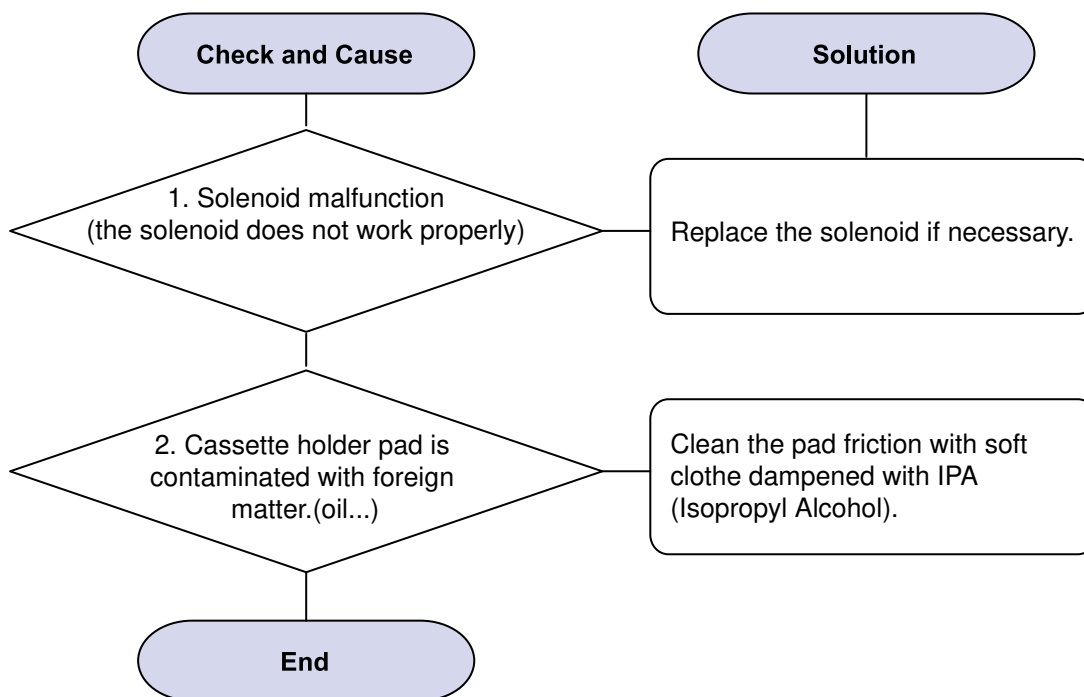

4) Paper rolled on the OPC Drum

Description : Paper is rolled up in the OPC.

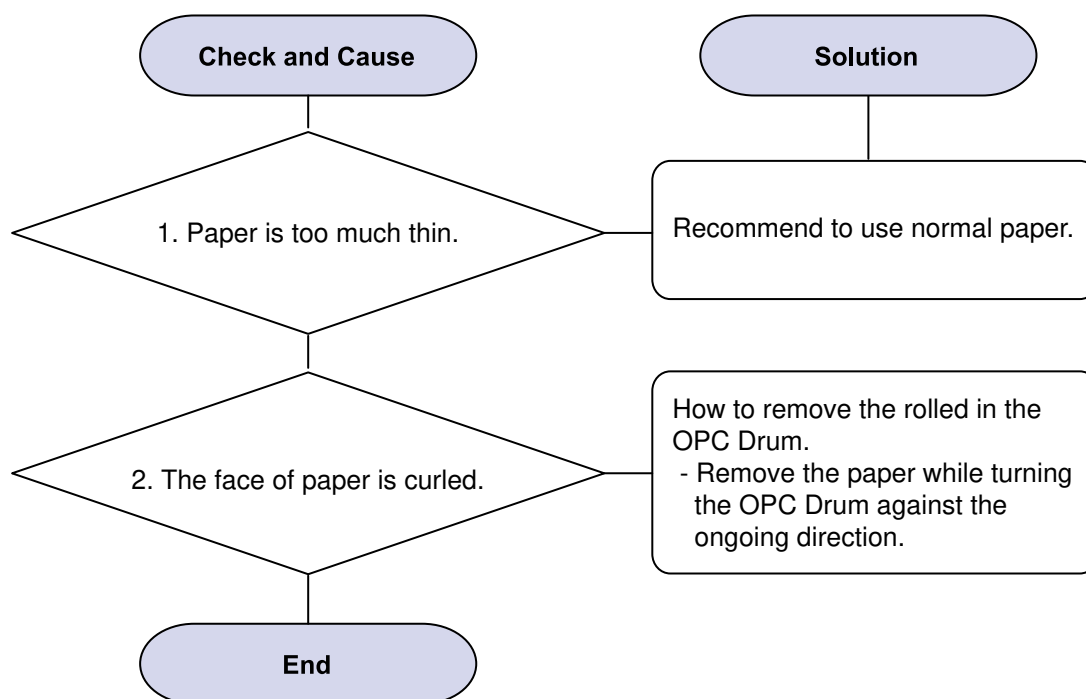

4.2.3 Malfunction

1) Paper Empty

Description : The paper lamp on the operator panel is on even when paper is loaded in the cassette.

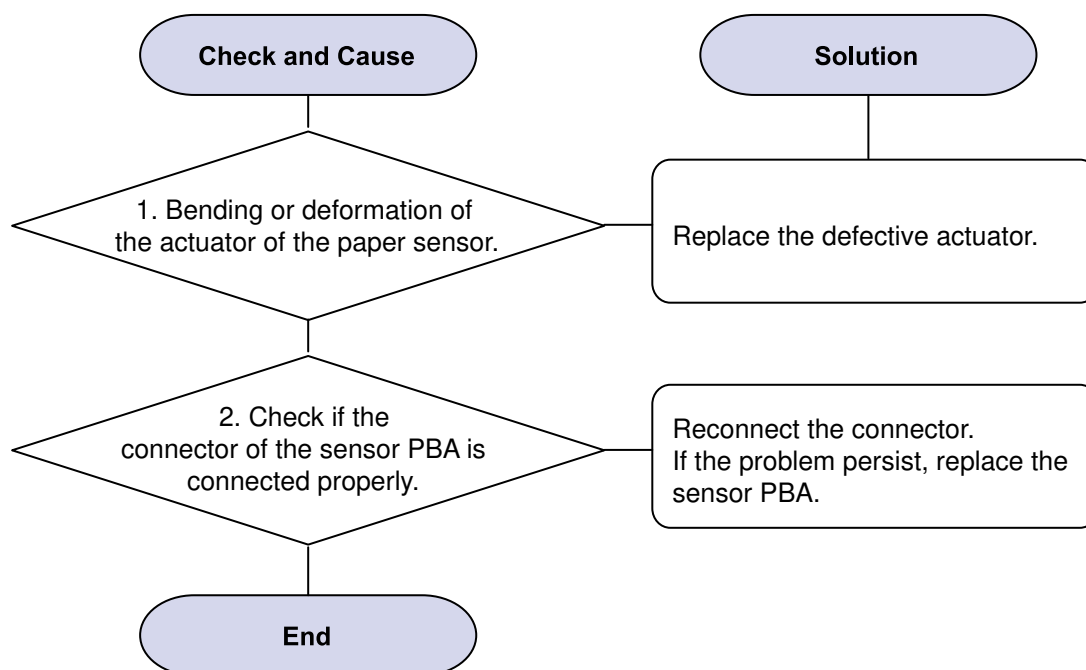

2) No lamp on when the cover is open

Description : The ERROR lamp does not come on even when the printer cover is open

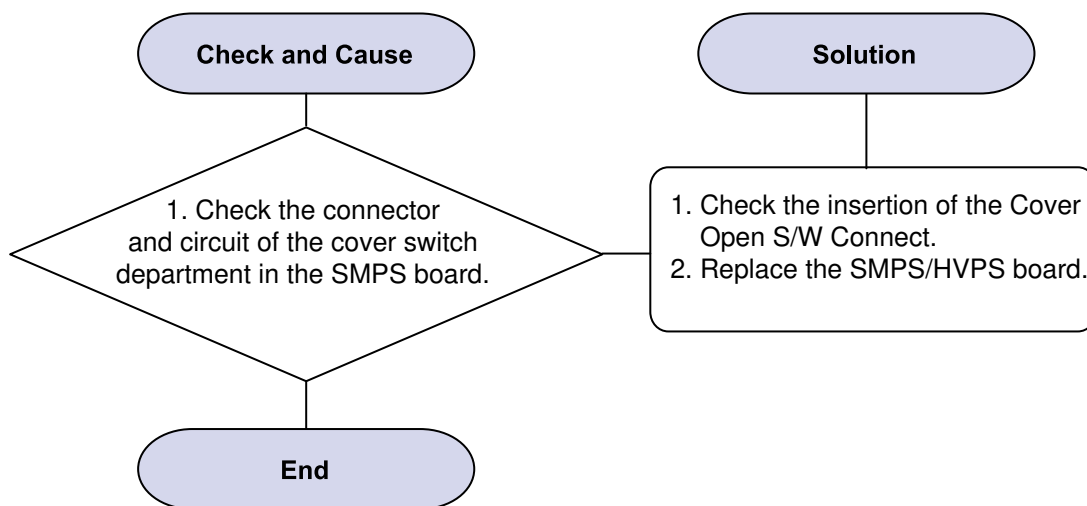

3) Defective motor operation

Description : Main motor is not driving when printing, and paper does not feed into the printer, resulting 'Jam 0'.

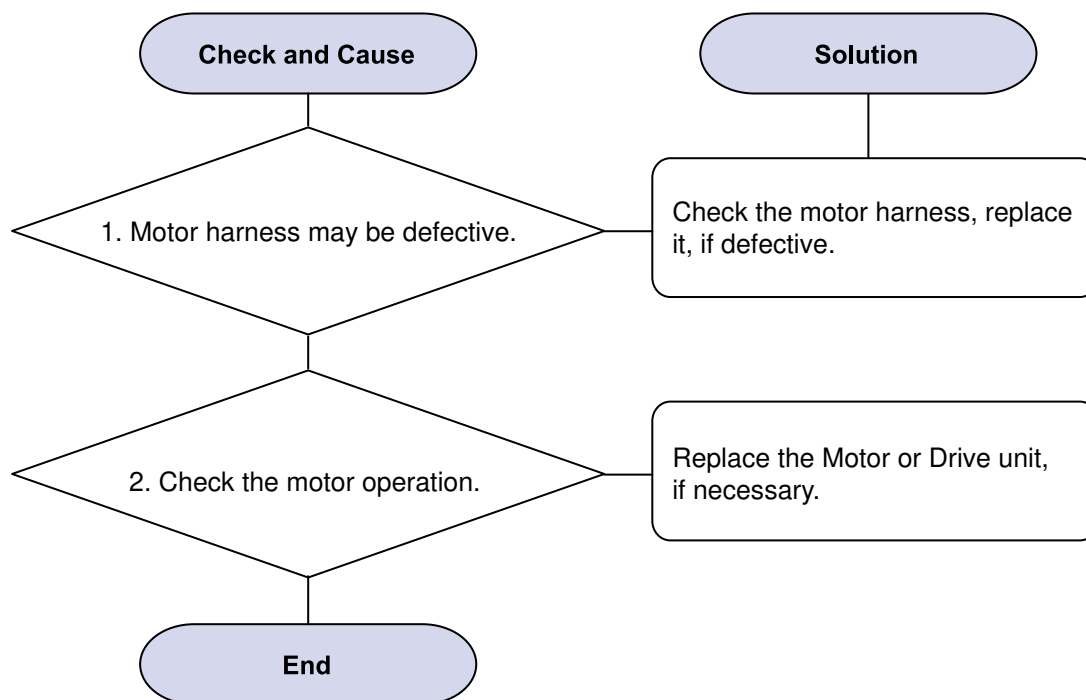

4) No Power

Description : When system power is turned on, all lamps on the operator panel do not come on.

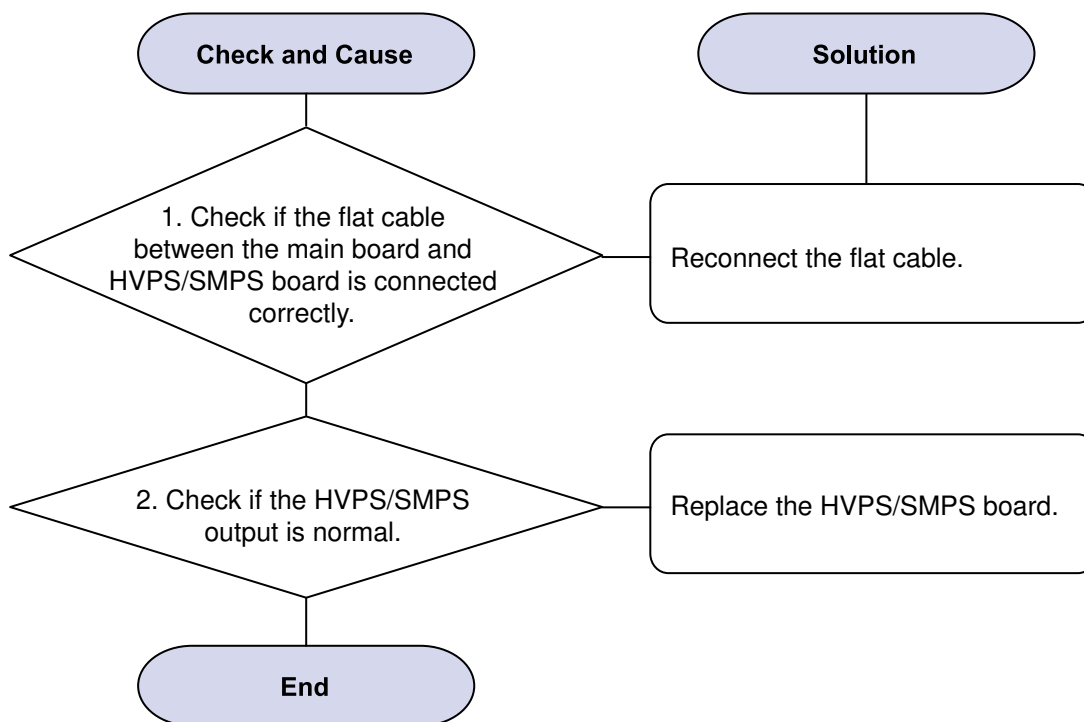

5) Vertical Line Getting Curved

Description : When printing, vertical line gets curved.

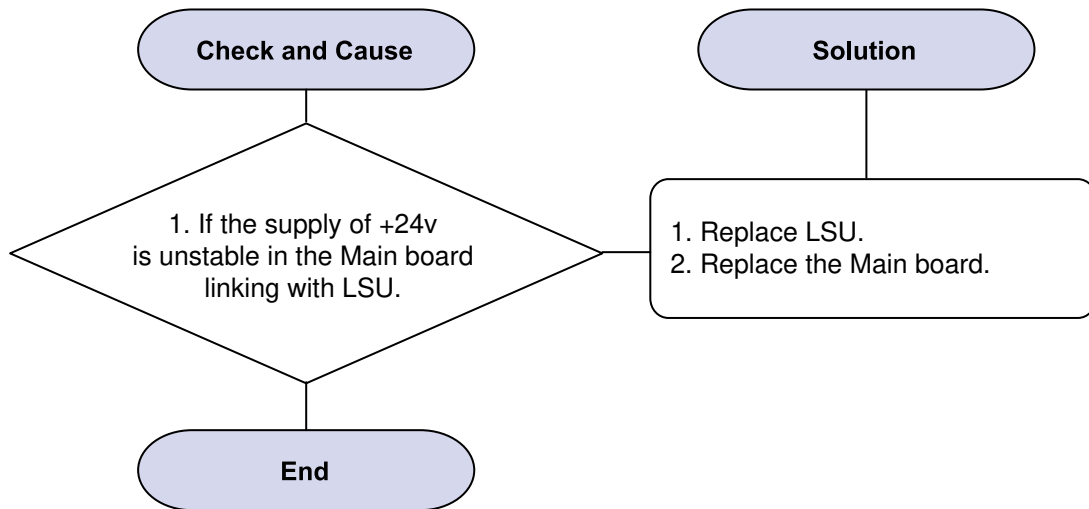

4.2.4 Bad image

1) Vertical Black Line and Band

Description : 1. Straight thin black vertical line occurs in the printing.
2. Dark black vertical band occur in the printing.

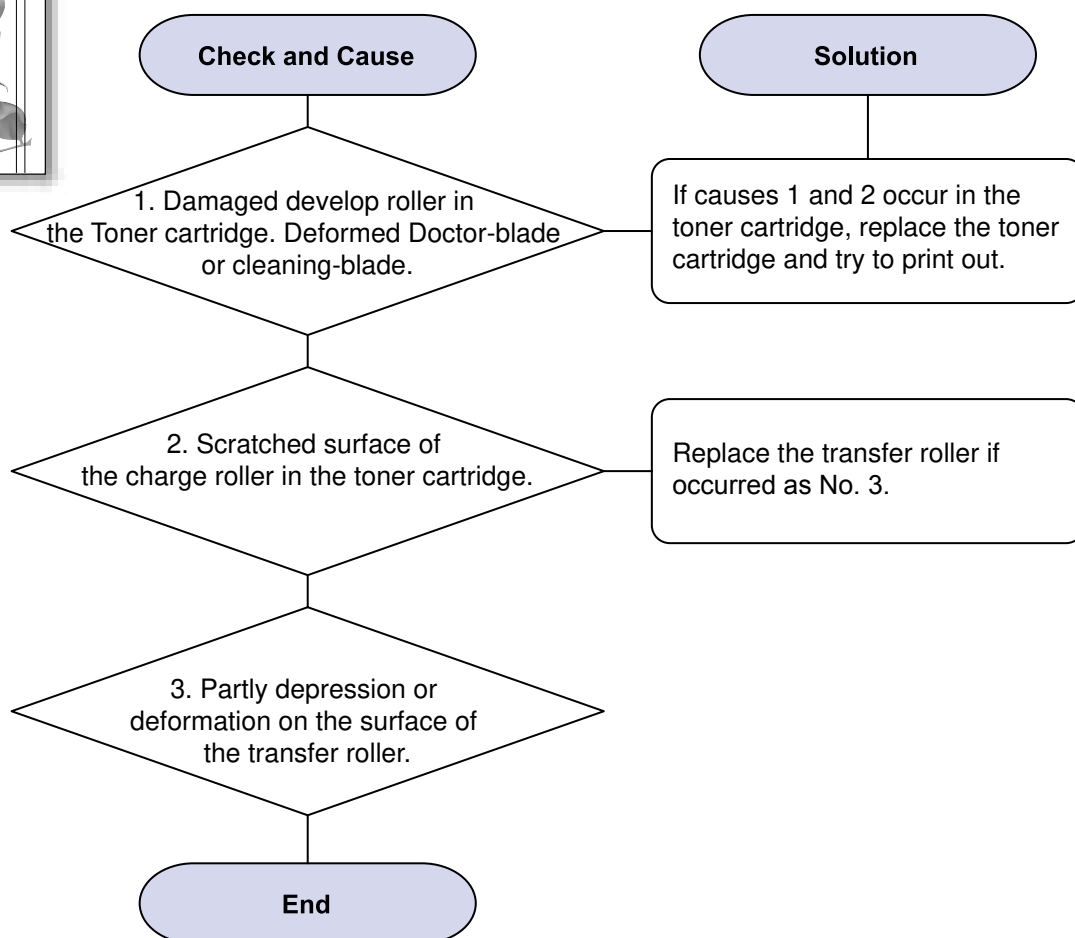

2) Vertical White Line

Description : White vertical voids in the image.

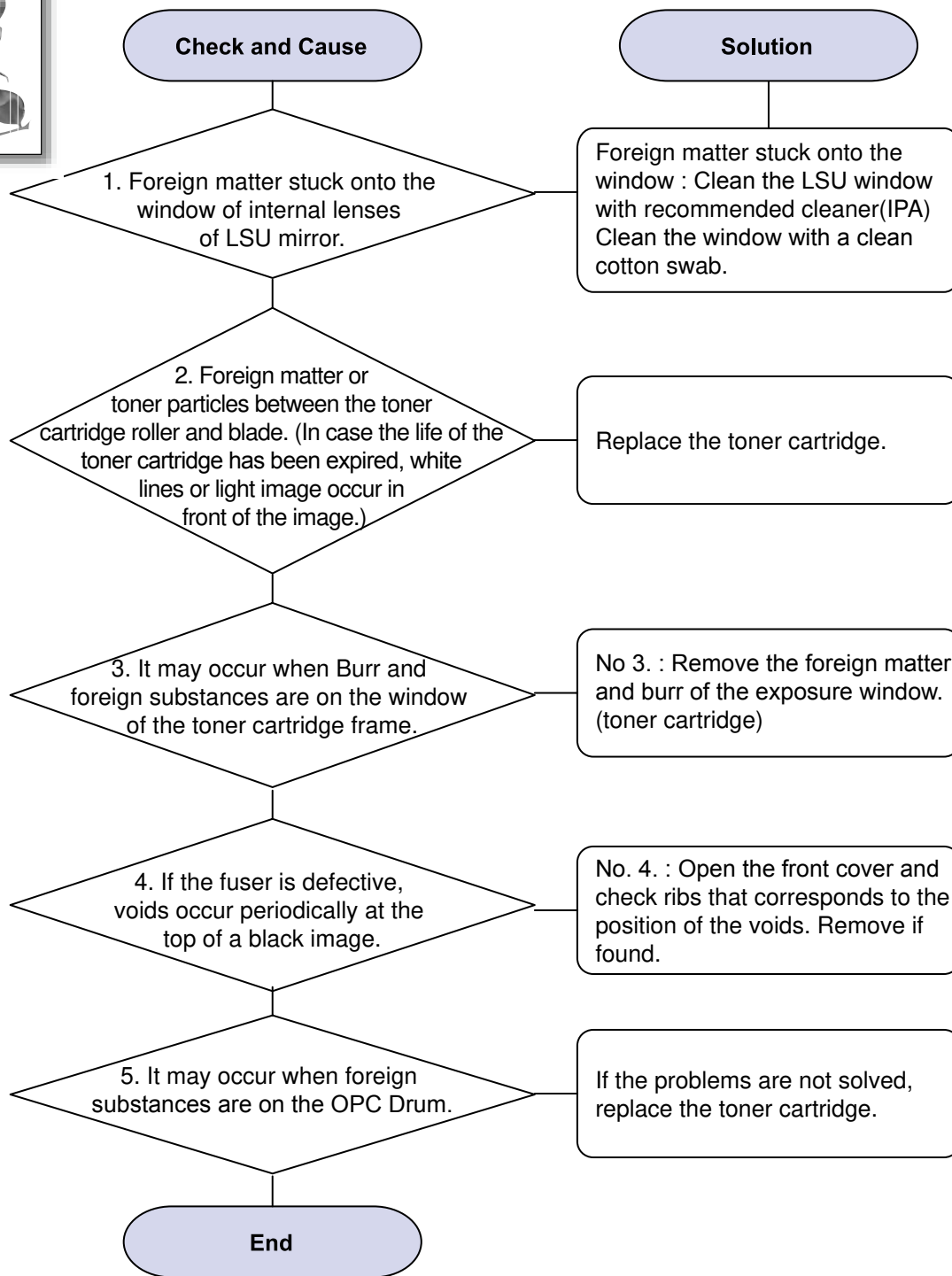
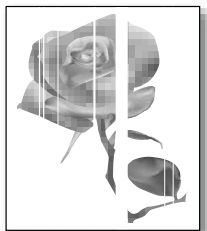

3) Horizontal Black Band

Description : Dark or blurry horizontal stripes occur in the printing periodically.
(They may not occur periodically.)

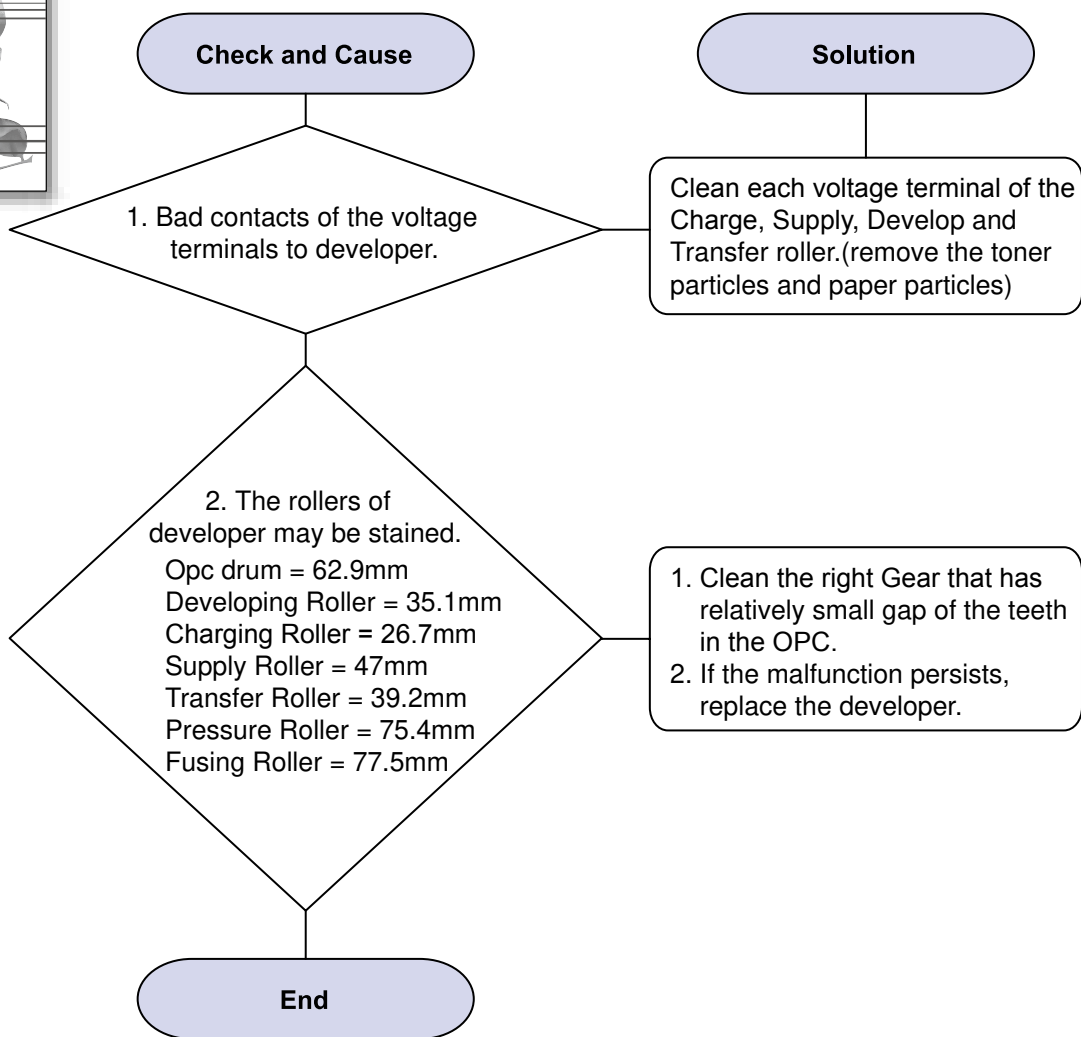
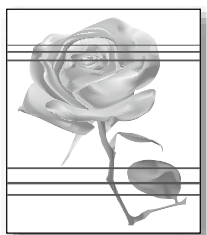

4) Black/White Spot

Description : 1. Dark or blurry spots occur periodically in the printing
 2. White spots occur periodically in the printing

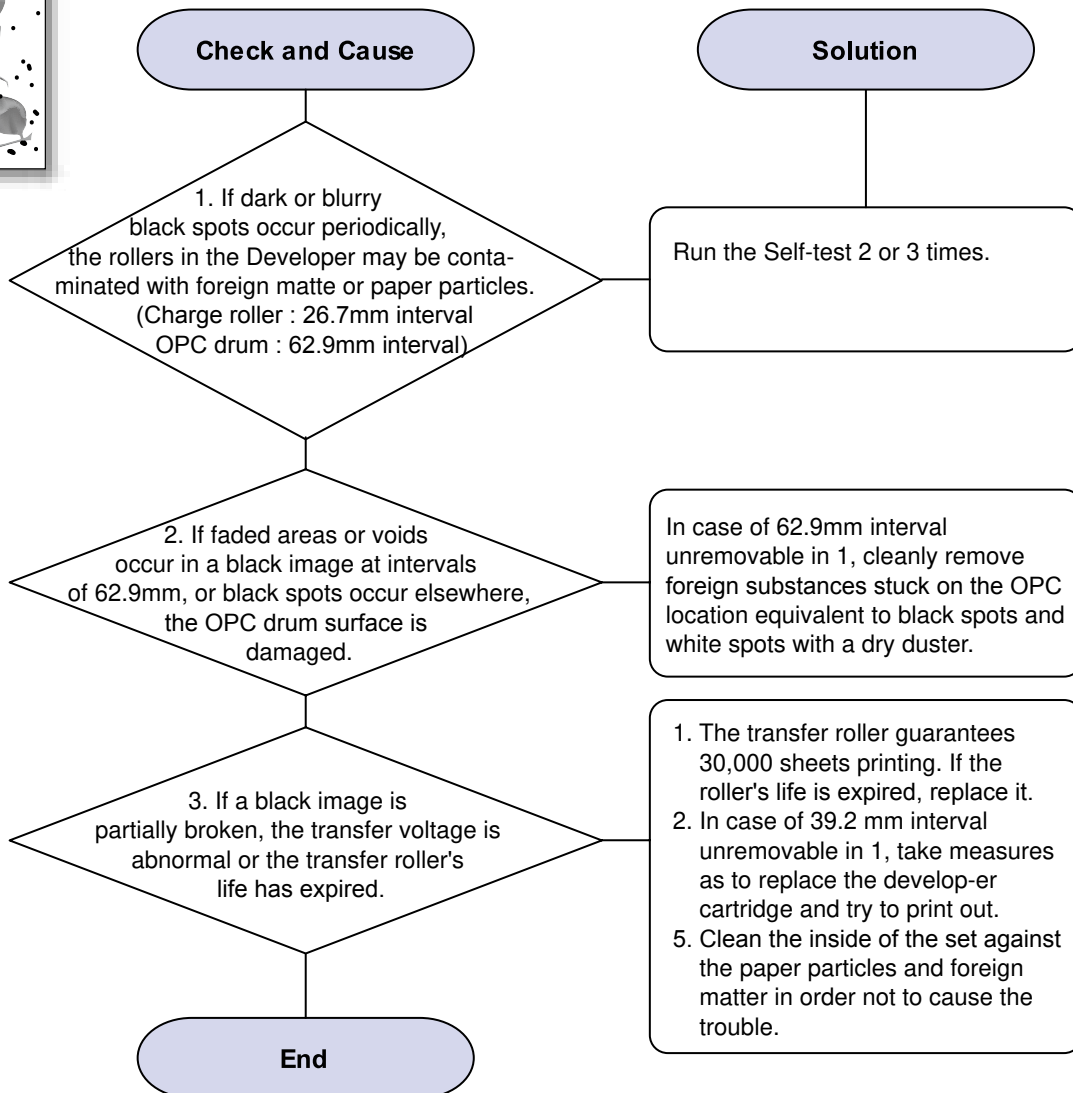
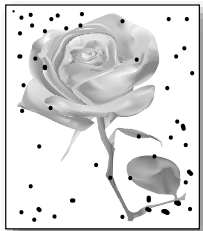

5) Light Image

Description : The printed image is light, with no ghost.

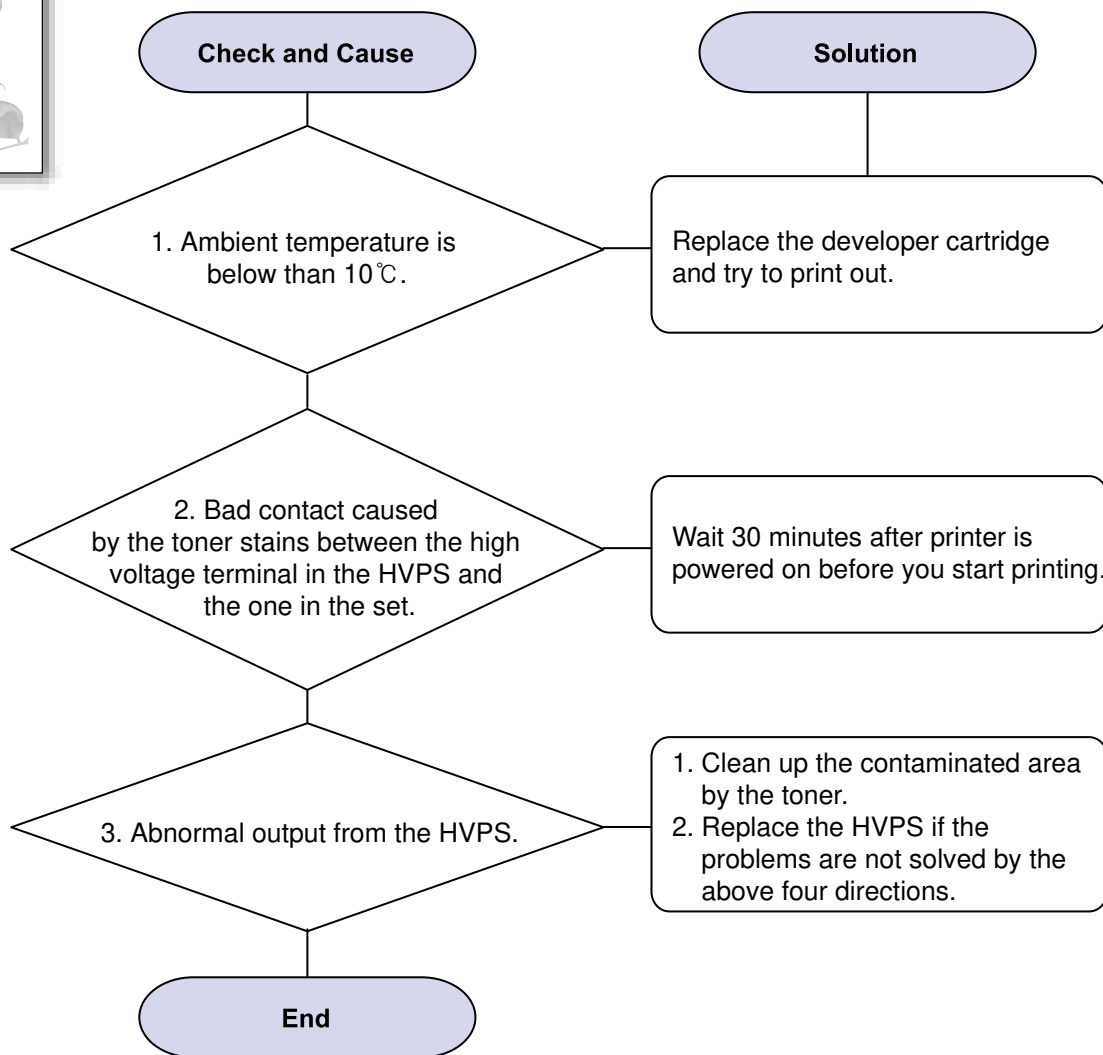

6) Dark Image or a Black Page

Description : The printed image is dark.

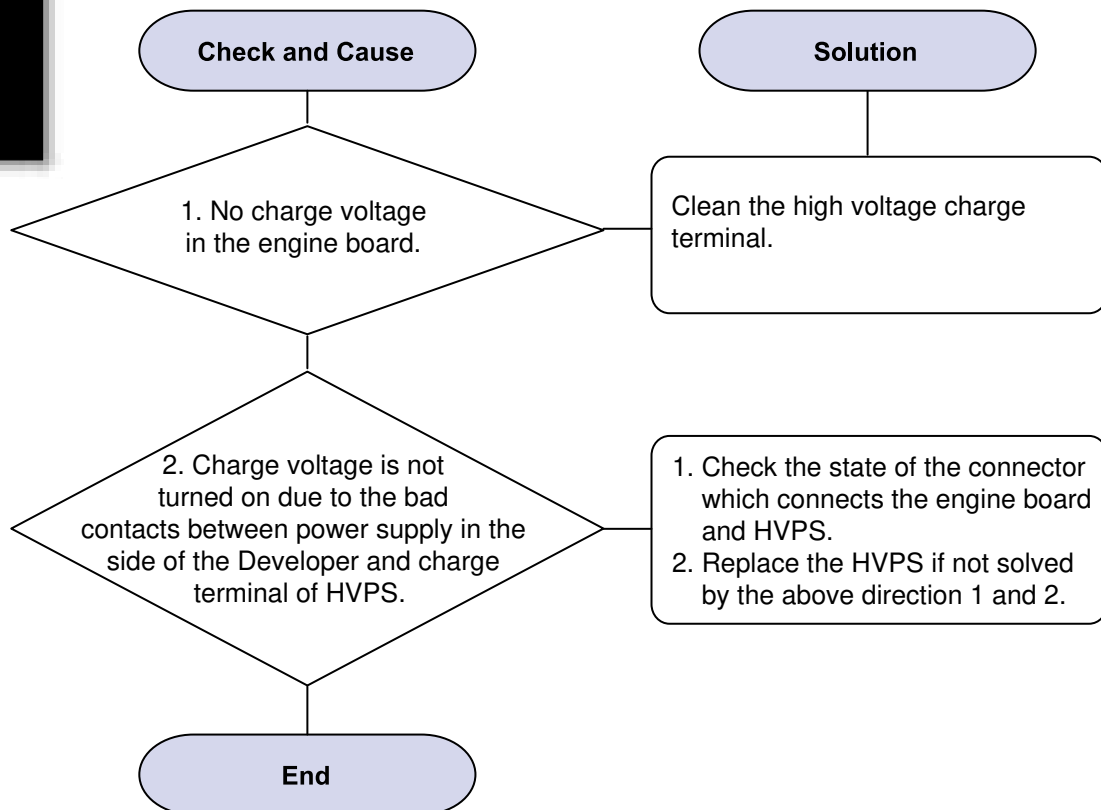
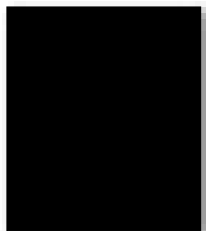

7) Background

Description : Light dark background appears in whole area of the printing.

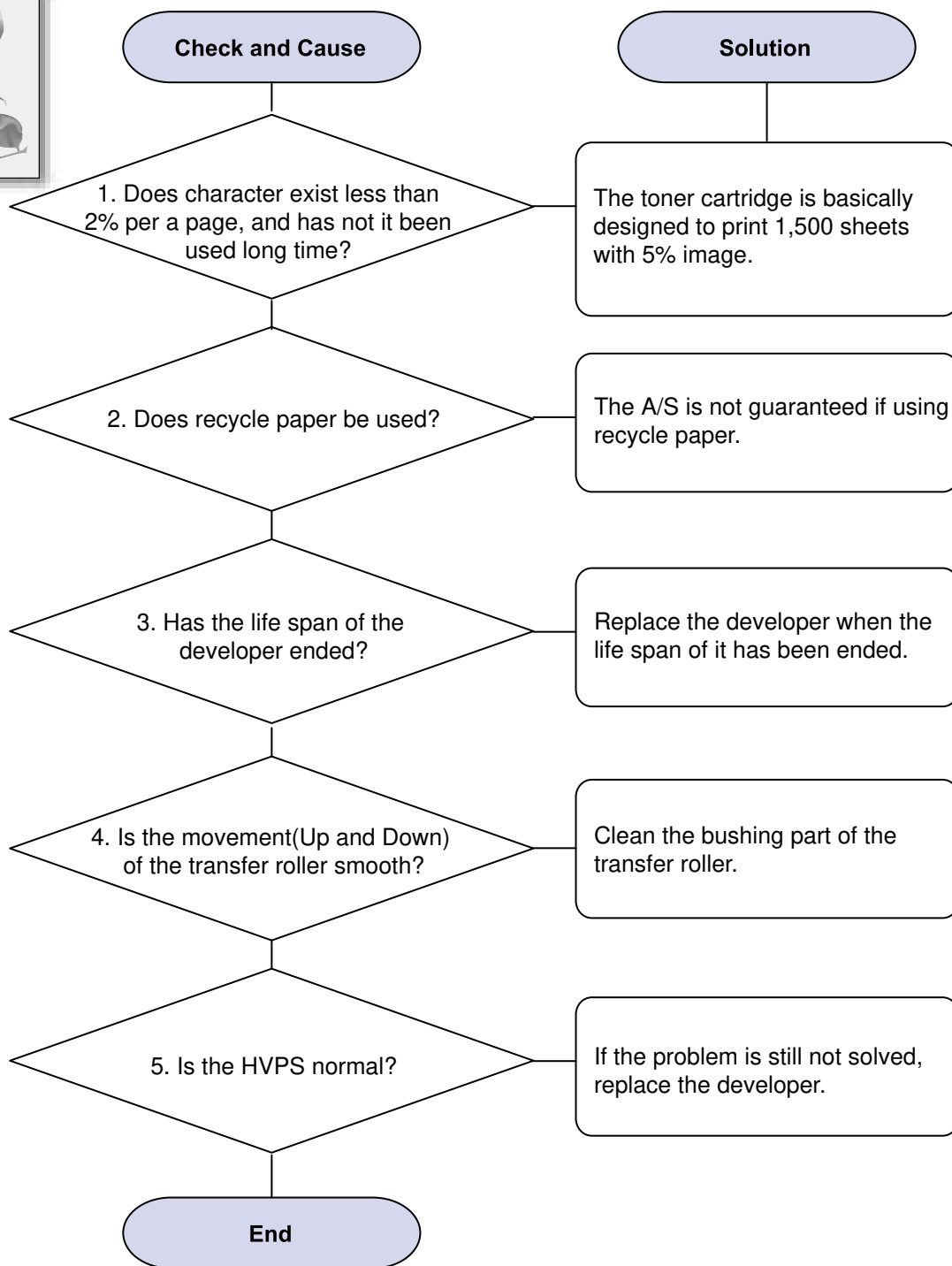

8) Ghost (1)

Description : Ghost occurs at 62.9 mm intervals of the OPC drum in the whole printing.

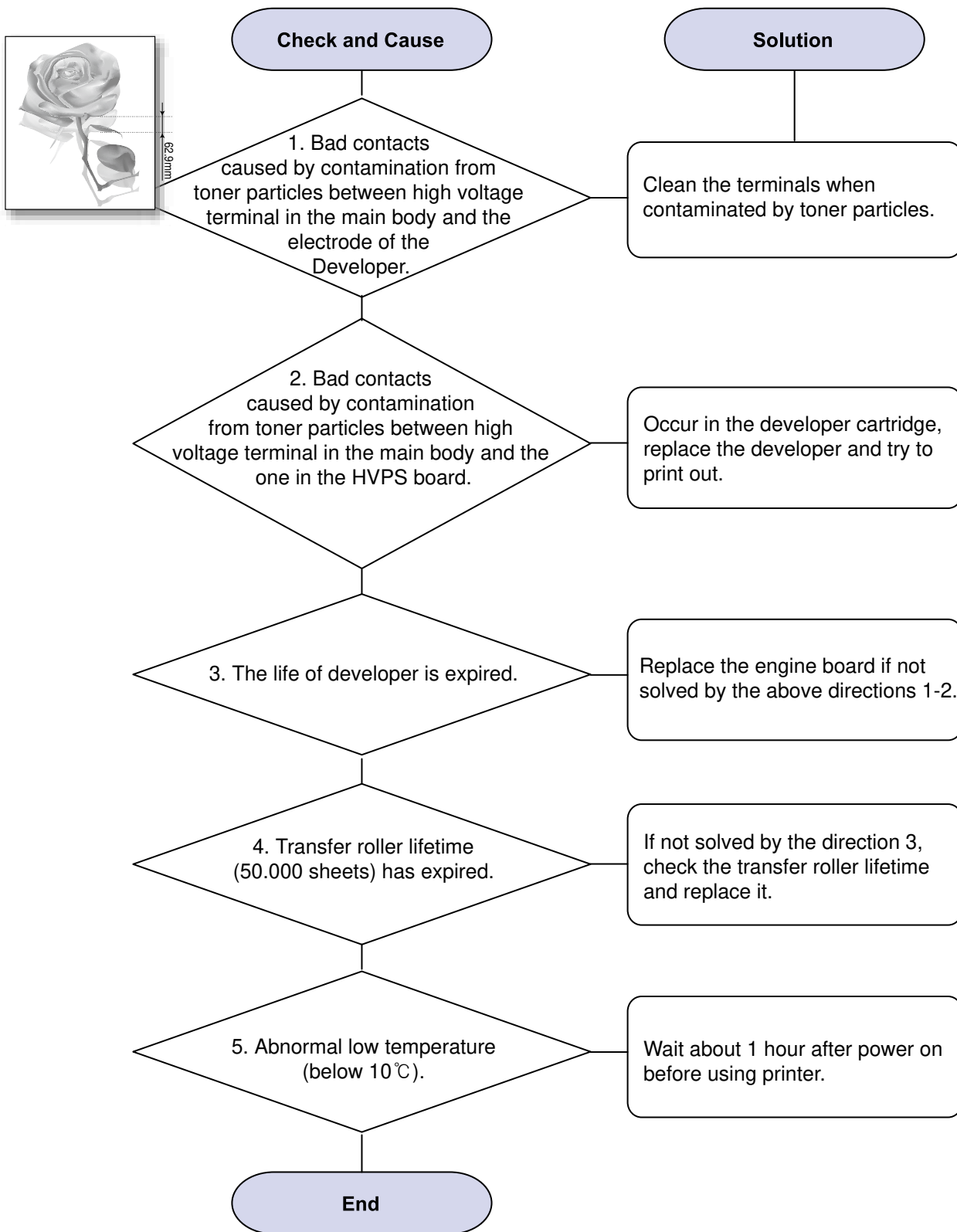

9) Ghost (2)

Description : Ghost occurs at 62.9 mm intervals of the OPC drum in the whole printing.
(When printing on card stock or transparencies using manual feeder)

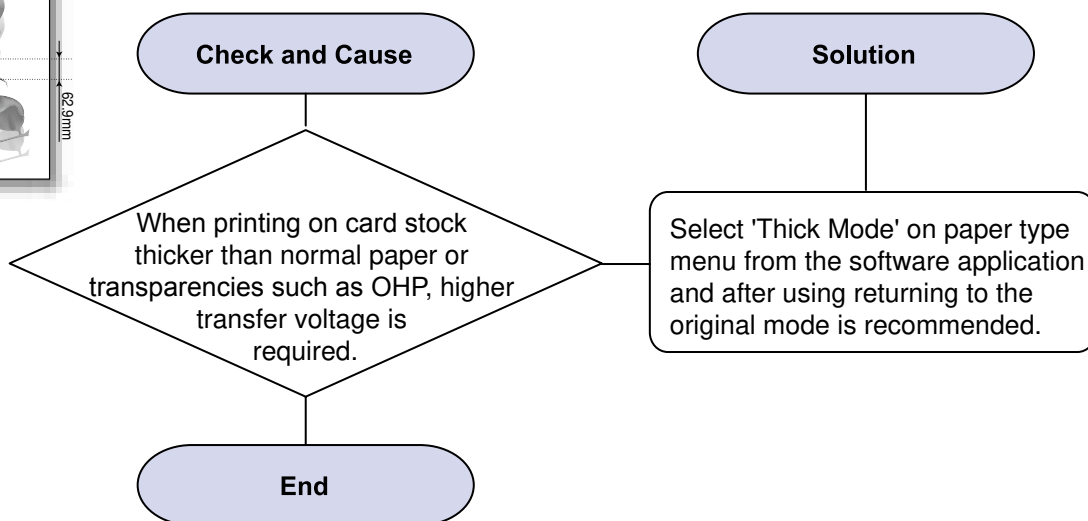
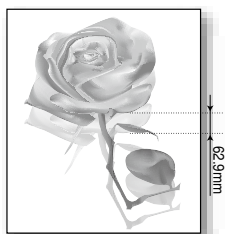

10) Ghost (3)

Description : White ghost occurs in the black image printing at 47 mm intervals.

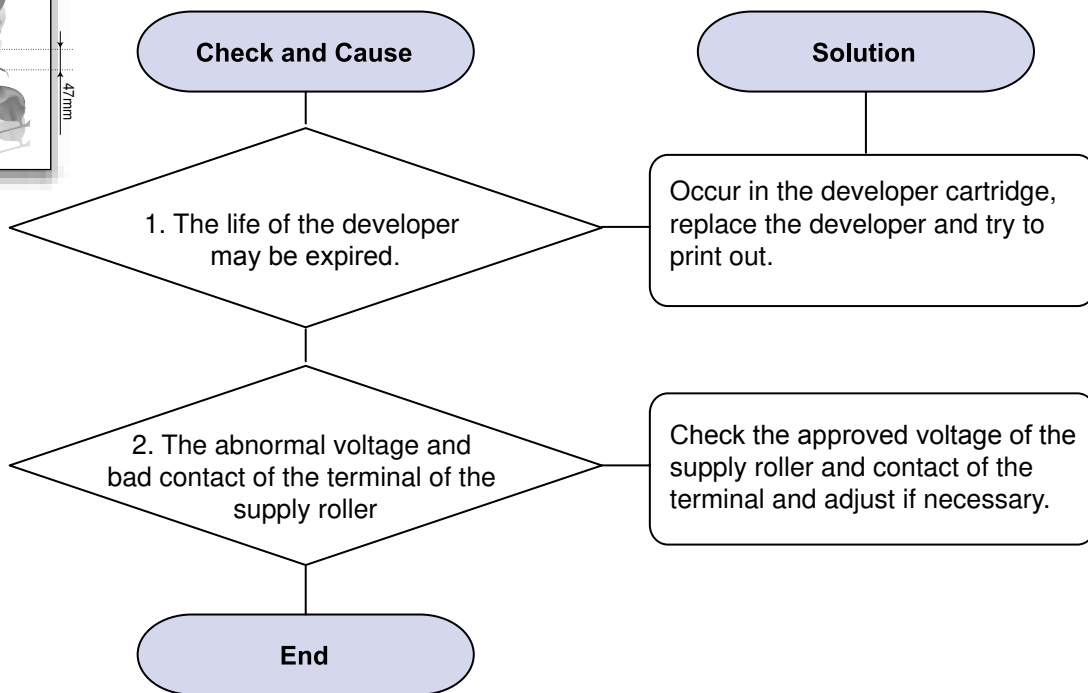
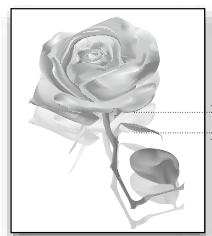

11) Ghost (4)

Description : Ghost occurs at 47 mm intervals.

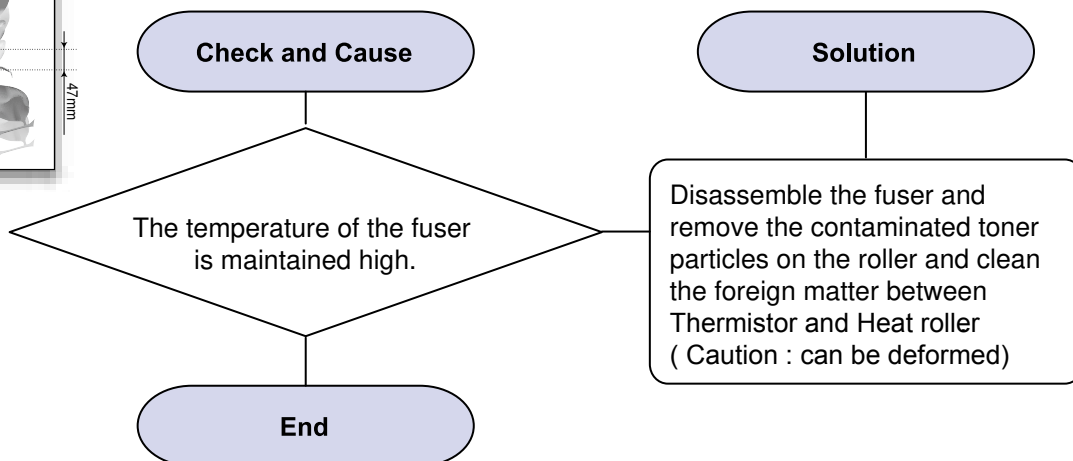
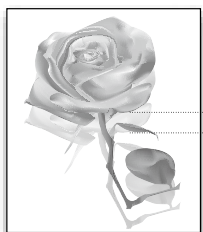

12) Stains on the Face of Page

Description : The background on the face of the printed page is stained.

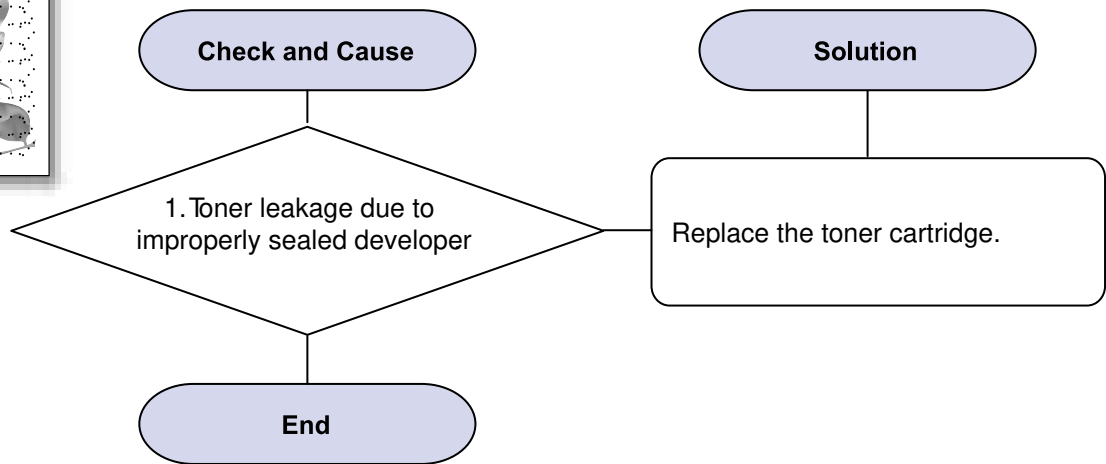
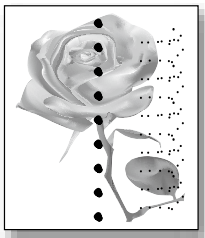

13) Stains on Back of Page

Description : The back of the page is stained at 39.2 mm intervals.

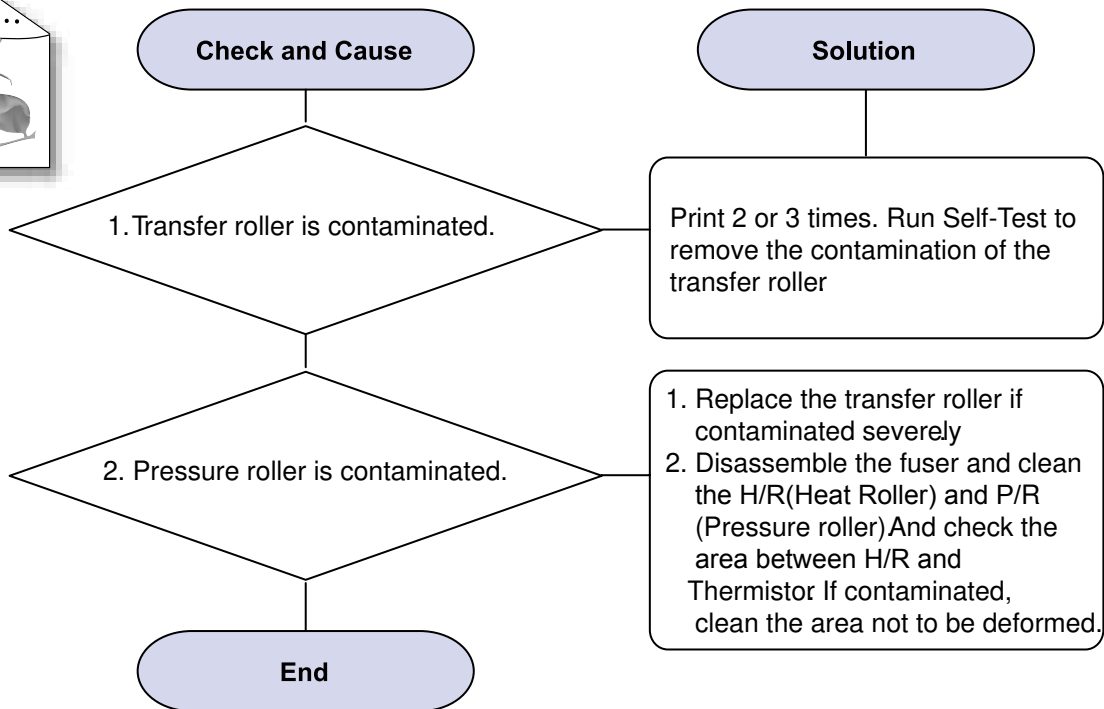
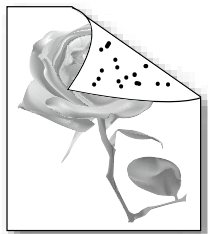

14) Blank Page Print out (1)

Description : Blank page is printed.

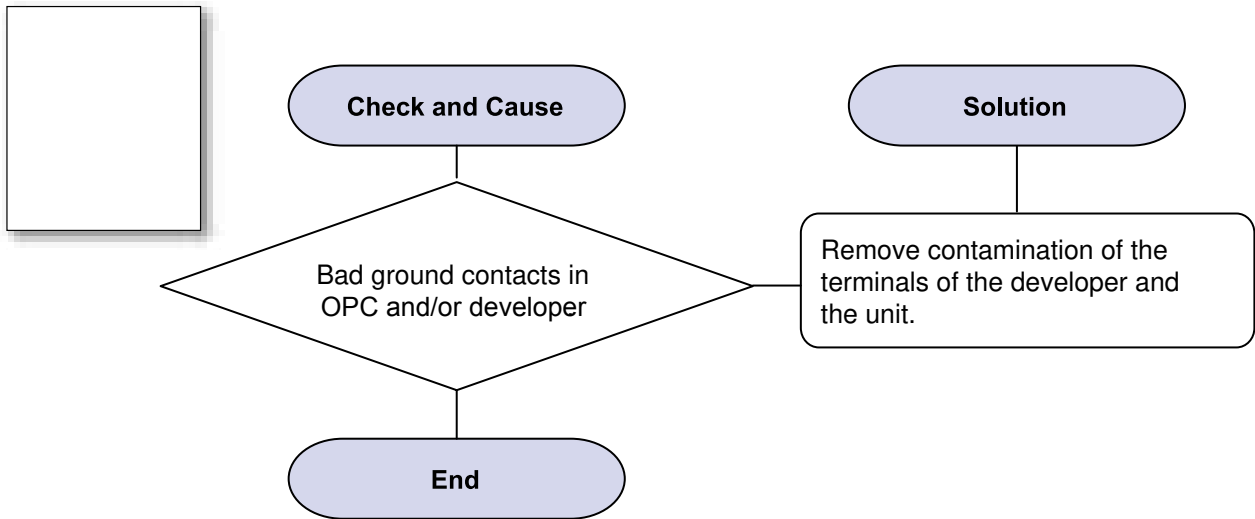

Code	Error message
A3-3112	SMART PANEL:Actuator Sensor Failure #A3-3112:Turn off then on.
C1-1110	SMART PANEL:Prepare new toner cartridge
C1-1120	SMART PANEL:End of life, Replace with new toner cartridge
C1-1130	SMART PANEL:End of life, Replace with new toner cartridge
C1-1411	SMART PANEL:Toner cartridge is not installed. Install the cartridge.
C1-1512	SMART PANEL:Toner cartridge is not compatible. Check users guide
M1-1113	SMART PANEL:Paper jam in tray 1.
M2-1211	SMART PANEL:
S2-4110	SMART PANEL:Door is open. Close it.
U1-1211	SMART PANEL:Fuser Unit Failure : #U1-1211. Turn off then on.
U1-2121	SMART PANEL:Fuser Unit Failure : #U1-2121. Turn off then on.
U2-1112	SMART PANEL:LSU Unit Failure: #U2-1112. Turn off then on.
U2-1114	SMART PANEL:LSU Failure: #U2-1114. Turn off then on.

• **Code:**A3-3112

• **Error message:** SMART PANEL:Actuator Sensor Failure #A3-3112:Turn off then on.

• **Symptom/Cause:**

1. The thermistor is open.
2. The thermistor harness is short.
3. The main board is defective.

• **Trouble Shooting Method:**

1. Remove the both side cover.



2. Remove the screw from the rear.



3. Remove the Cover-Top.



4. Remove the Cover-Exit.



5. Remove the metal plate after unplugging the fuser connector.

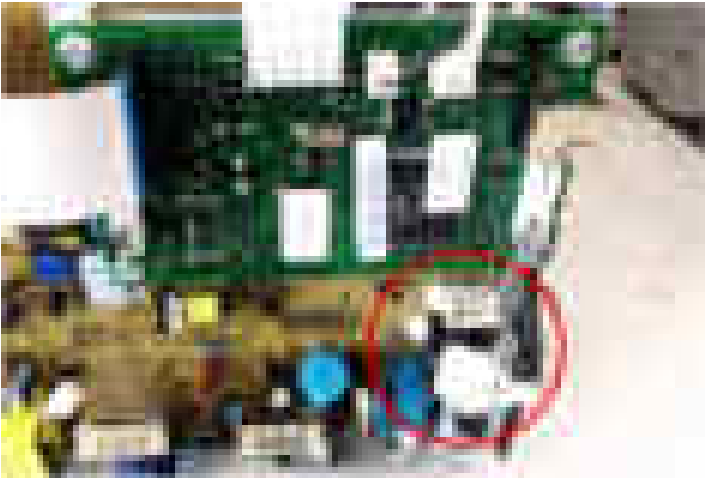

6. Replace the fuser unit after removing 1 screw.



7. The assembly is reverse order of disjoining.

• **Code:**C1-1110

• **Error message:** SMART PANEL:Prepare new toner cartridge

• **Symptom/Cause:**

1. The toner cartridge has reached its estimated cartridge life.

• **Trouble Shooting Method:**

1. Open the Cover-Exit.



2. Replace the toner cartridge.



3. Close the Cover-Exit.



• **Code:**C1-1120

• **Error message:** SMART PANEL:End of life, Replace with new toner cartridge

• **Symptom/Cause:**

1. The toner cartridge has reached its estimated cartridge life.

• **Trouble Shooting Method:**

1. Open the Cover-Exit.



2. Replace the toner cartridge.



3. Close the Cover-Exit.



• **Code:**C1-1130

• **Error message:** SMART PANEL:End of life, Replace with new toner cartridge

• **Symptom/Cause:**

1. The toner cartridge has reached its estimated cartridge life.
Print the supplies information report. And check the life count.

• **Trouble Shooting Method:**

1. Open the Cover-Exit.



2. Replace the toner cartridge.



3. Close the Cover-Exit.



• **Code:**C1-1411

• **Error message:** SMART PANEL:Toner cartridge is not installed. Install the cartridge.

• **Symptom/Cause:**

1. The toner cartridge is installed improperly, or not installed.

• **Trouble Shooting Method:**

1. Open the Cover-Exit.



2. Reinstall the toner cartridge two or three times to confirm it is seated properly.



3. Close the Cover-Exit.



• **Code:**C1-1512

• **Error message:** SMART PANEL:Toner cartridge is not compatible. Check users guide

• **Symptom/Cause:**

1. The toner cartridge is not suitable for your machine.
2. The print job can't be executed.

• **Trouble Shooting Method:**

1. Prepare the Samsung-genuine toner cartridge.
2. Open the Cover-Exit.



3. Replace the toner cartridge.



4. Close the Cover-Exit.



• **Code:**M1-1113

• **Error message:** SMART PANEL:Paper jam in tray 1.

• **Symptom/Cause:**

1. Paper has jammed.
(The paper has not reached the feed1 sensor within normal time after picking up it from the tray.)

• **Trouble Shooting Method:**

1. Remove all papers on the tray. Remove the jammed paper from the machine. And reload the papers on the tray.
2. Adjust the paper guide to fix the papers.

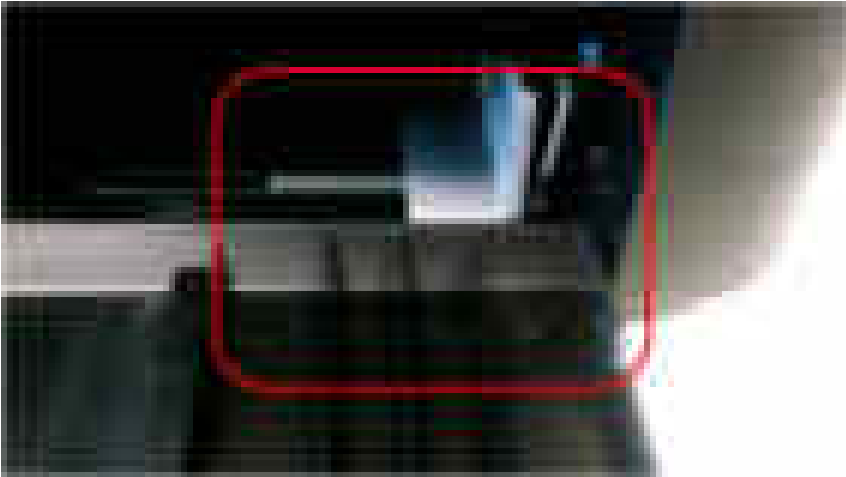

3. Check the maximum paper capacity of the tray. Remove excess paper from the tray.



• **Code:**M2-1211

• **Error message:** SMART PANEL:

• **Symptom/Cause:**

1. Paper has jammed. (In case that the printer has turned on after turned it off for printing job or pick-up.)

• **Trouble Shooting Method:**

1. Open the top cover. Check if the paper has jammed. If there is the jammed paper, remove it.
2. If the error message in Smart Panel is not disappeared, check the Regi sensor and actuator. If they are defective, replace them.



• **Code:**S2-4110

• **Error message:** SMART PANEL:Door is open. Close it.

• **Symptom/Cause:**

1. Error LED on the control pane is blinking because the main door is opened.

• **Trouble Shooting Method:**

1. Close the cover unit it locks into place.



2. If the problem persists, check the cover open sensor that is located on the HVPS board.

• **Code:**U1-1211

• **Error message:** SMART PANEL:Fuser Unit Failure : #U1-1211.
Turn off then on.

• **Symptom/Cause:**

1. The fuser unit is defective.
2. The SMPS Triac is defective.
3. The main board is defective.

Using an incorrect type of paper may create a fusing error. Please use only paper that meets the specifications required by the machine.

• **Trouble Shooting Method:**

1. Remove the both side covers.



2. Remove the screw from the rear.



3. Remove the Cover-Top.



4. Remove the Cover-Exit.



5. Remove the metal plate after unplugging the fuser connector.

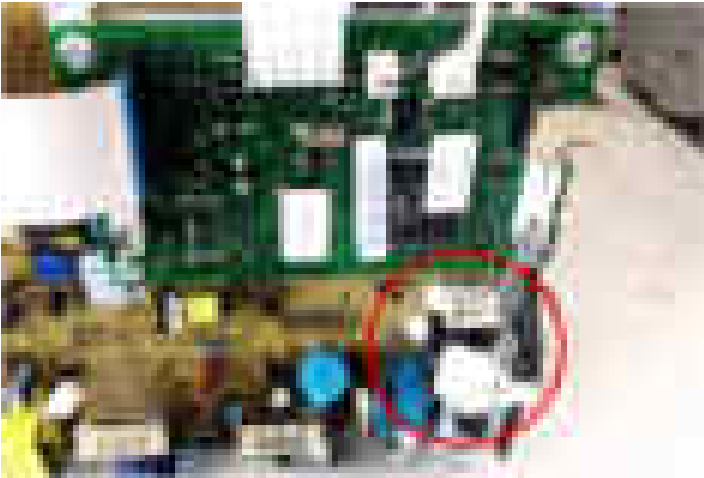

6. Replace the fuser unit after removing the screw.



7. The assembly is reverse order of disjoining.

• **Code:**U1-2121

• **Error message:** SMART PANEL:Fuser Unit Failure : #U1-2121.
Turn off then on.

• **Symptom/Cause:**

1. The fuser unit is defective.
2. The SMPS Triac is defective.
3. The main board is defective.

Using an incorrect type of paper may create a fusing error. Please use only paper that meets the specifications required by the machine.

• **Trouble Shooting Method:**

1. Remove the both side covers.



2. Remove the screw from the rear.



3. Remove the Cover-Top.



4. Remove the Cover-Exit.



5. Remove the metal plate after unplugging the fuser connector.

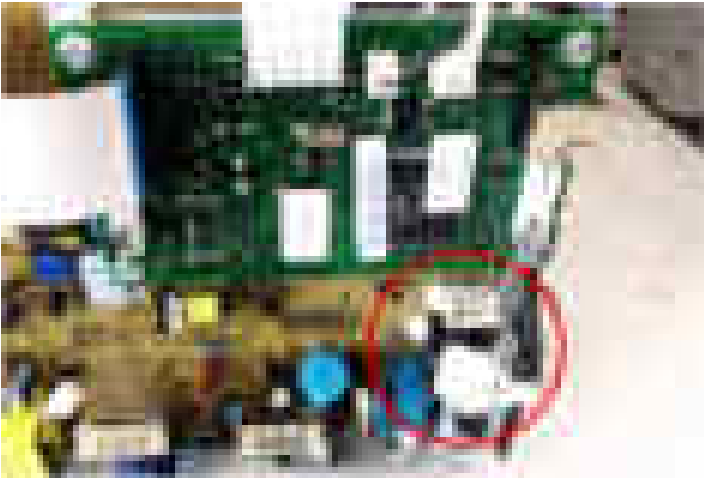

6. Replace the fuser unit after removing the screw.



7. The assembly is reverse order of disjoining.

• **Code:U2-1112**

• **Error message:** SMART PANEL:LSU Unit Failure: #U2-1112. Turn off then on.

• **Symptom/Cause:**

1. An error between the LSU(Laser Scanning Unit) and the control circuit of the Main board has occurred.

• **Trouble Shooting Method:**

1. Check the LSU connector.



2. Replace the LSU.
3. If the problem persists, replace the main board.

• **Code:**U2-1114

• **Error message:** SMART PANEL:LSU Failure: #U2-1114. Turn off then on.

• **Symptom/Cause:**

1. An error between the LSU(Laser Scanning Unit) and the control circuit of the Main board has occurred.

• **Trouble Shooting Method:**

1. Check the LSU connector.



2. Replace the LSU.
3. If the problem persists, replace the main board.

5. System Diagram

5.1 Block Diagram

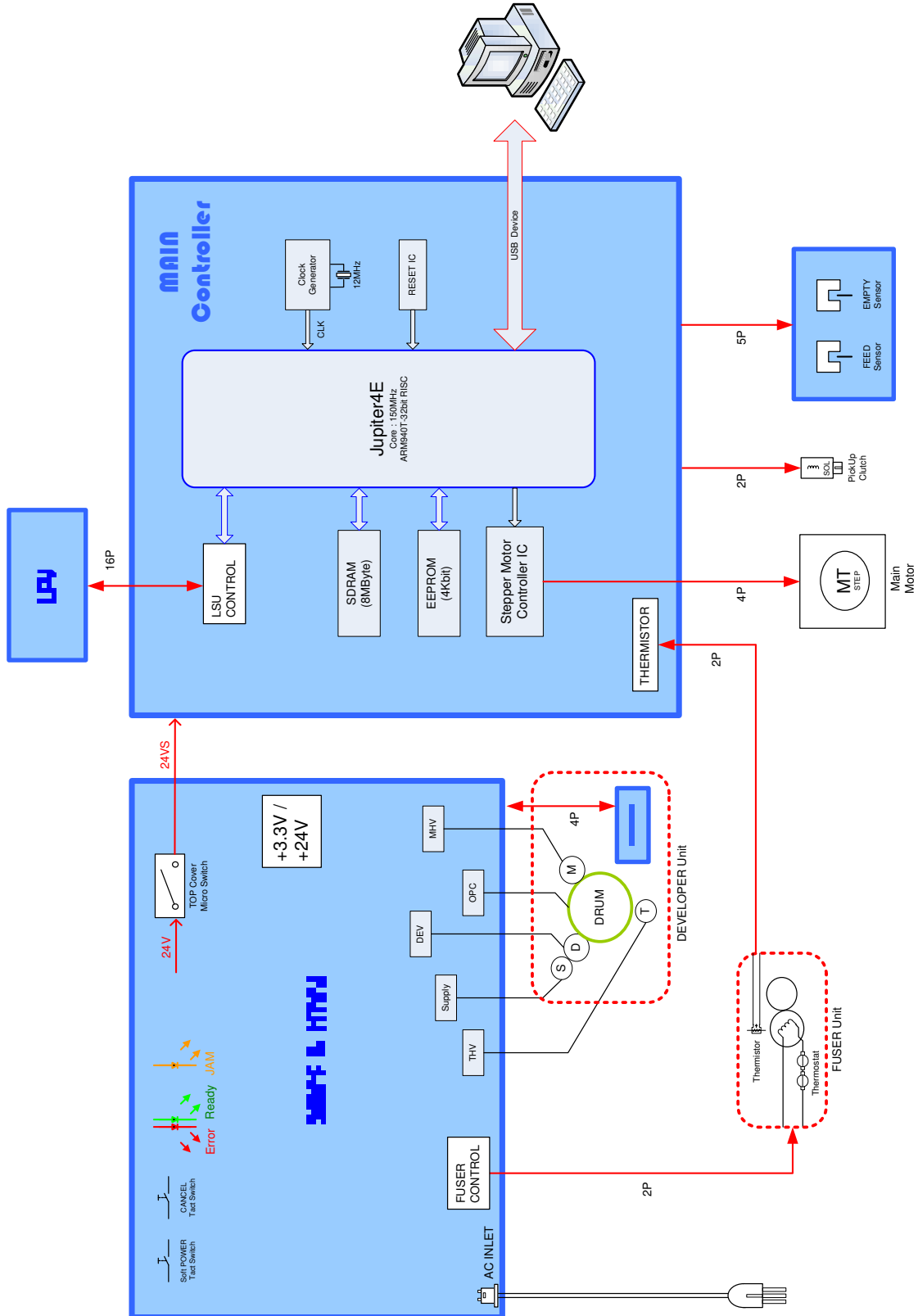

5.2 Connection Diagram

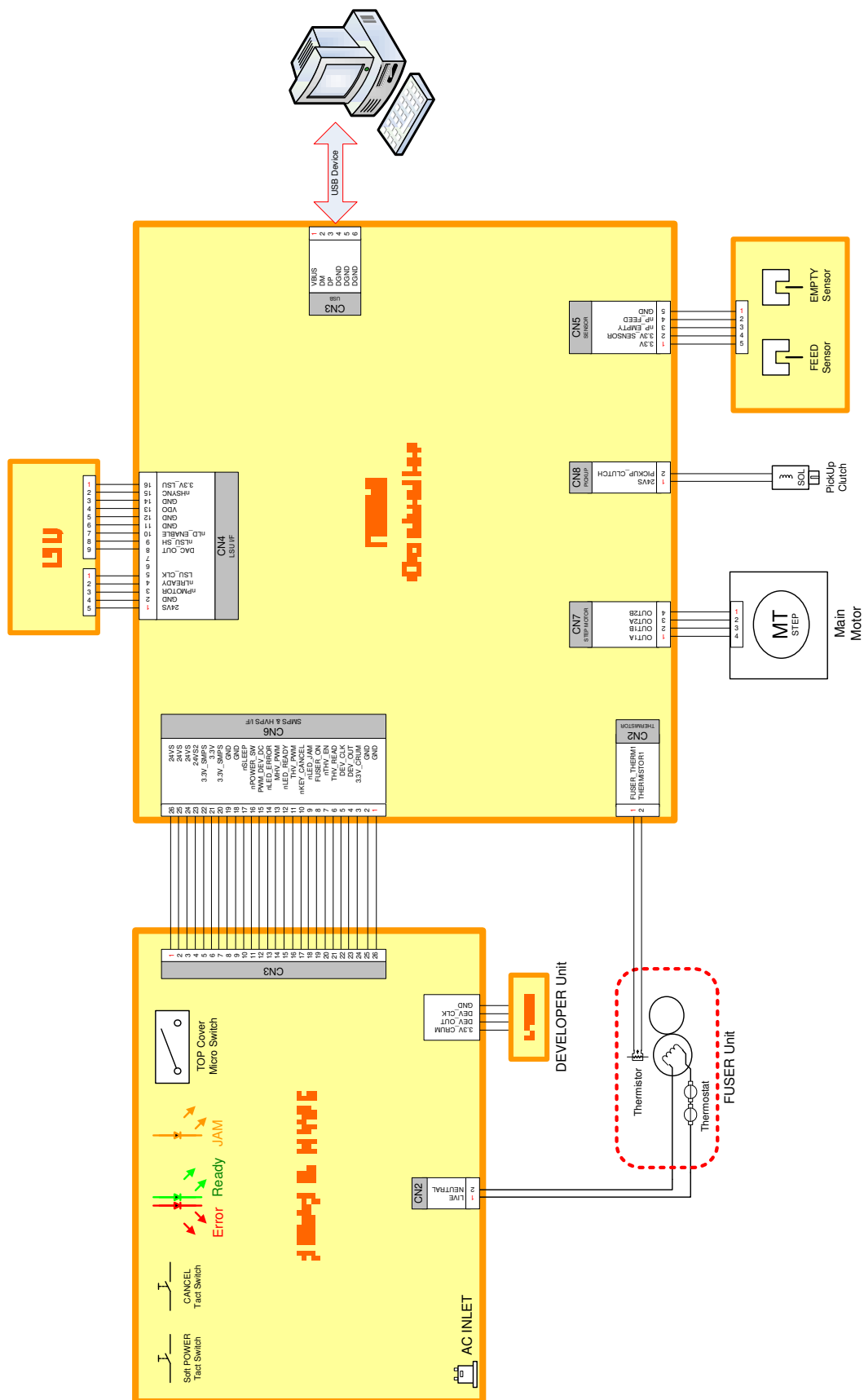

6. Reference Information

This chapter contains the tools list, list of abbreviations used in this manual, and a guide to the location space required when installing the printer. A definition of test pages and Wireless Network information definition is also included.

6.1 Tool for Troubleshooting

The following tools are recommended safe and easy troubleshooting as described in this service manual.

- **DVM (Digital Volt Meter)**

Standard : Indicates more than 3 digits.

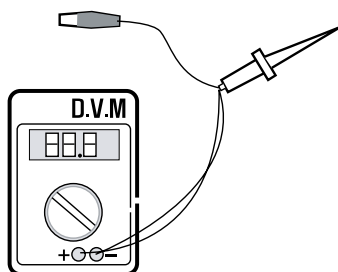

- **Driver**

Standard : "-" type, "+" type (M3 long, M3 short, M2 long, M2 short).

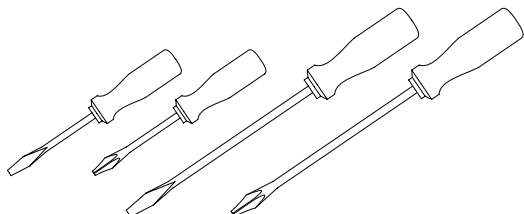

- **Tweezers**

Standard : For general home use, small type.



- **Cotton Swab**

Standard : For general home use, for medical service.



- **Cleaning Equipments**

Standard : An IPA (Isopropyl Alcohol) dry wipe tissue or a gentle neutral detergent and lint-free cloth.

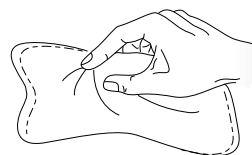

- **Vacuum Cleaner**

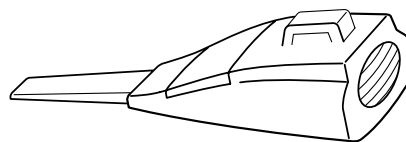

- **Spring Hook**

Standard : For general use



- **Software (Driver) installation CD ROM**

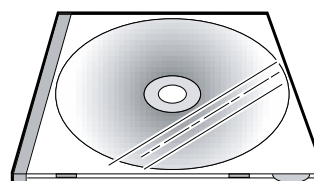

6.2 Acronyms and Abbreviations

The table below explains abbreviations used in this service manual.
The contents of this service manual are declared with abbreviations in many parts. Please refer to the table.

6.2.1 Acronyms

ABS	Automatic Background Suppression(a kind of copy feature)	FDI	Foreign Device Interface
APF	Automatic Paper Feeder(Tray)	FIA	Foreign Interface Attachment
BOOTP	BOOTSTRAP PROTOCOL	FRU	Field Replaceable Unit
CCD	Charged Coupled Device	FPOT	First Print Out Time
CIS	Contact Image Sensor	GW	GateWay
CPM	Copies Per Minute	HH	High Temperature, High Humidity (Testing Chamber conditions)
CP	Control Panel(= OPE)	HPVC	Halftone Printing Video Controller in the SPGPm (Graphic Processor for Copy)
CQ	Copy Quality	IDC	International Data Corp.
CRU	Customer Replaceable Unit	IMAP	Internet Message Access Protocol
CRUM	CRU Memory	IPP	Internet Printing Protocols
CW	Center Ware	IPM	Images Per Minutes
CWDP	Center Ware Device Discovery Software(Samsung equivalent of Samsung's SyncThru)	IPX	Internetwork Packet Exchange
CWIS	Center Ware Internet Services	IQ	Image Quality
DADF	Duplex Auto Document Feeder (= DADH)	ITU	International Telecommunication Union
DC	Direct Connect	JBIG	Joint Binary Image Group (a kind of image data coding method)
DDNS	Dynamic Domain Name System	JPEG	Joint Photographic Expert Group (a kind of image data coding method)
DHCP	Dynamic Host Configuration Protocol	LCD	Liquid Crystal Display
DLC	Data Link Control	LEF	Long Edge Feeding
DNS	Domain Name System	LL	Low Temperature, Low Humidity (Testing Chamber conditions)
ECM	Error Correction Mode	LPR/LPD	Line Printer Daemon Protocols (LPR is a TCP-based protocol)
ECP	Enhanced Capability Port	LSU	Laser Scanning Unit
e-Coil	Extended Coil technology for Rapid(Fast) Fusing.	LUI	Local User Interface
EH&S	Samsung Environment, Health, & Safty	MCBF	Mean Copy Between Failure
ESMTP	Extended Simple Mail Transfer Protocol	MDSP	Multiple Document Single Printout
EP	Electro Photography	MFP	Multi-Functional Product
EPC	Electric Pre-Collation	MH	Modified Huffman (a kind of image data coding method)
FCOT	First Copy Out Time		

MIB	Management Information Base	RT-OS	Real Time Operating System
MIME	Multipurpose Internet Mail Extensions	RX	Receive
MR	Modified Read (a kind of image data coding method)	S2E	Scan-To-Email
MMR	Modified and Modified Read (a kind of image data coding method)	SAD	Solid Area Density
MN std	Multi-National Standard	SC	Service Call
MSOK	Master SOK(System Operation Key)	SCF	Second Cassette Feeder
MSO	Mixed Size Original	SDSP	Single Document Single Printout
MP	Multi Purpose	SDMP	Single Document Multiple Printout
MPBF	Mean Print Between Failure	SDR	Shut Down Rate
MSI	Multi Sheet Input	SEF	Short Edge Feeding
MTBF	Mean Time Between Failure	SIR	Sacrificed(or Standard) Image Reference
MTTR	Mean Time To Repair	SOK	System Operation Key
NCP	Network Control Protocol	sRGB	Standard RGB (Color Coordinate System)
NIC	Network Interface Card	SNMP	Simple Network Management Protocol
NOS	Network Operating System	TCP/IP	Transmission Control Protocol/Internet Protocol
NN	Normal Temperature, Normal Humidity (Testing Chamber conditions)	TBC(or tbc)	To Be Confirmed
NSDR	Non-Shut Down Rate(=USDR)	TBD(or tbd)	To Be Determined
NW	Network	TIFF	(Adobe & Aldus) Tagged Image File Format
OD	Optical Density	TRIM	Technical Retrofit Interim Maintenance
OHD	On Hook Dial	TTM	Time to Market
OSOK	Optional SOK(System Operation Key)	TX	Transmit
OP	Operational Procedure	UI	User Interface
PCL	Printer Control Language	UMC	Unit Manufacturing Cost
PDF	(Adobe) Portable Document Format	UMR	Unscheduled Maintenance Ratio
PPM	Pages Per Minutes	UPnP	Universal Plug and Play
PQ	Print Quality	USB	Universal Serial Bus
PS/3	PostScript Level-3	USDR	Un-Shut Down Rate(=NSDR)
PVC	Printing Video Controller in the SPGPm(Graphic Processor for Printer)	XCMI	Samsung's Management Information Base
QCD	Quality, Cost, and Delivery	WA	Warranty Action
RCP	Remote Control Panel	W x D x H	Width x Depth x Height

6.2.2 Service Parts

ACRONYM	EXPLANATION
ELA HOU-SCANNER ASS'Y	ELA=Electrical Assembly, HOU =Housing
MEA UNIT-COVER PA EXIT ASS'Y	MEA= Mechanical Assembly, PA=Paper
PMO-TRAY EXTENTION MP NE	PMO= Processing Mold MP=Multi-Purpose(Bypass) tray NE=for NEC (common as Samsung Halk printer)
MEC-CASSETTE ASS'Y(LETTER)	MEC = Mechanic Combined unit
COVER-M-FRONT	M=Mold
MPR-NAME/PLATE	MPR= Machinery Press,
UNIT-LSU	LSU =Laser Scanning Unit
SMPS-SMPS(V1)+HVPS	SMPS =Switching Mode Power Supply HVPS =High Voltage Power Supply
ELA-OPC UNIT SET	OPC=Organic Photo-Conductive
ELA HOU-MP ASS'Y	MP =Multi-Purpose (Bypass) tray
PBA MAIN-MAIN	PBA =Printed circuit Board Assembly
PMO-CONNECT PAPER MFP	MFP =Multi-Functional Peripheral
FAN-DC	DC =Direct Current
CBF POWER STITCH GRAY	CBF= Cable Form
MEA UNIT GUIDE CST PA ASS'Y	CST=Cassette(Paper tray), PA=Paper
PBA LIU	PBA =Printed circuit Board Assembly LIU =Line Interface Unit for FAX
SHIELD-P_MAIN LOWER	P=Press
CBF HARNESS-LIU GND	LIU =Line Interface Unit for FAX GND= Ground
PMO-COVER FEED AY	AY=Assembly
PMO-COVER BRKT MOTER	BRKT=Bracket
CBF HARNESS-LSU	LSU =Laser Scanning Unit
IPR-SHIELD SMPS UPPERI	IPR=Iron Press
PMO-BUSHING P/U.MP	P/U=Pickup MP=Multi-Purpose (Bypass) Tray
PMO-HOLDER GEAR TRr	TR= Transfer Roller
SPRING ETC-TR_L	TR_L=Transfer Roller - Left
PMO-CAM JAM REMOVE	PMO-CAM= Processing Mold-CAM
PMO-LOCKER DEVE	DEVE=Developer

ACRONYM	EXPLANATION
SPECIAL SCREW(PANNEL MFP)	MFP =Multi-Functional Peripheral
A/S MATERAL-DUMMY UPPER ASS'Y	A/S=After-Service
MCT-GLASS ADF	MCT= Machinery Cutting ADF=Automatic Document Feeder
PPR-REGISTRATION EDGE(F)	PPR= Processing Press
IPR-HOLDER GLASSI	PR=Iron Press
MCT-GLASS SCANNER(LLEGAL)	MCT= Machinery Cutting
CBF HARNESS-OPE	OPE=Operation Panel(Control Panel)
PBA SUB-D_SUB	PBA SUB-D_SUB =>Sub Printed circuit Board Assembly for the D-SUB type electrical connector (D-Sub) a kind of the connector type(shape 'D')
COVER-M-CCD CABLE	M=Mold CCD=Charge Coupled Device
COVER-SCAN LOWER(UMAX)	UMAX=> Supplier's name for CCD module
ICT-INSERT SHAFTI	ICT= Iron Cutting
IPR-BRK SCAN BD	IPR=Iron Press BRK=Bracket BD= Board
CBF SIGNAL-CCD FFC	CCD = Charge Coupled Device FFC =Flexible Flat Cable
COVER-M-OPE	M=Mold OPE=Operation Panel(Control Panel)
KEY-M-COPY	M=Mold
PLATE-M-ALPHA KEY	M=Molde ALPHA=Alphabet
PMO-GUIDE DP SIDE	DP=Duplex
RING-CS	CS= Compress
GEAR-MP/DUP DRV	MP =Multi-Purpose (Bypass) tray DUP DRV = Duplex Driver
IPR-BRKT G DUPI	PR=Iron Press BRKT=BRACKET G= Ground UP=Duplex
PMO-BUSHING TX(B4)	TX=Transmit
PMO-TRAY CASE, MP	MP=Multi-Purpose tray(Bypass tray)

ACRONYM	EXPLANATION
SPRING CS RE	CS=Compress RE=Rear
SPRING CS FR	CS=Compress FR=Front
PMO-BUSHING FINGER, F	F=Front
ICT-SHAFT-EXIT LOWER ID	ID=Idler
SPRING-EXIT ROLL FD	FD=Face Down
PMO-BUSHING_P/U,MP	P/U=Pickup MP =Multi-Purpose (Bypass) tray
PMO-HOLDER CAM MPF	MPF=Multi-Purpose Feeder(=MP)
PMO-GEAR P/U MPF	P/U=Pickup
MFP =Multi-Functional Peripheral	
RPR-RUBBER PICK UP,MP	RPR=Rubber Press
PBA SUB-MP SEN	PBA SUB-MP-SEN =>Sub Printed circuit Board Assembly for the MP-SEN(= Multi-Purpose (Bypass) tray-Sensor)
A/S MATERIAL-PICKUP,MP	
FOOT-ML80	
HOLDER CATCH CST MC2	MC2=>McKinley2 (Samsung Project code name)
IPR-GROUND PLATE A(OPC)	OPC=Organic Photo-Conductive
ELA M/M-AUD SPEAKER	ELA M/M => Electrical Assembly M/M AUD=Audio
CBF HARNESS-OPC GND	OPC GNG=Organic Photo-Conductive-Ground
IPR-GROUND PLATE SCF	SCF=Second Cassette Feeder(Tray2)
PBA SUB-PTL	PBA SUB-PTL=>Sub Printed circuit Board Assembly for the PTL(= Pre Transfer Lamp)
PBA SUB-FEED+P.EMP SEN.	PBA SUB-FEED=>Sub Printed circuit Board Assembly for the feeder EMP SEN=Empty Sensor
MOTOR STEP-MCK2(MAIN)	
GEAR-EXIT/U	EXIT/U=EXIT/Upper
GEAR-RDCN FEED INNER	RDCN=Reduction
CBF-HARNESS-MAIN-THV WIRE	THV =Transfer High Voltage
CBF-HARNESS-MAIN-MHV WIRE	MHV= High Voltage(Charge Voltage)

ACRONYM	EXPLANATION
GEAR-EXIT/U, ID	U=Upper ID=Idler
IPR-TERMINAL FU	FU=Fuser
PMO-BEARING H/R-F	H/R-F=Heat Roller - Front
BEARING-H/R L	H/R-L=Heat Roller -Left
PEX-ROLLER EXIT F_UP	PEX= Processing Extrude F_UP=Face Up
SPRING ETC-P/R	P/R=Pressure Roller
SPRING(R)-CAU-HOT-FU	CAU-HOT-FU = Caution Hot -Fuser
PMO-ARM ACTUATOR	PMO-ARM= Processing Mold Arm
LABEL(R)-HV FUSER	HV=High Voltage (220V)
LABEL(R)-LV FUSER	LV=Low Voltage (110V)
PPR-SPONG SHEET	PPR=Plastic Press
IPR-P_PINCH(SCAN)I	PR-P = Iron Press
ROLLER-REGI	REGI=Registration
PBA SUB-REGI	PBA SUB-REGI => Sub Printed circuit Board Assembly for the Registration
GROUND-P_SCAN ROLLER	GROUND-P =Ground-Press
IPR-GUARD C/O S/W	C/O = Cover Open S/W= Switch
MEA UNIT-TX STACKER	TX =Transmit
IPR-WASHER SPRING CU	CU=Curve

6.3 The Sample Pattern for the Test

The sample pattern shown in below is the standard pattern used in the factory.
 The life of the toner cartridge and the printing speed are measured using the pattern shown below.
 (The image is 70% of the actual A4 size).

6.3.1 A4 ISO 19752 Standard Pattern

This test page is reproduced at 70% of the normal A4 size

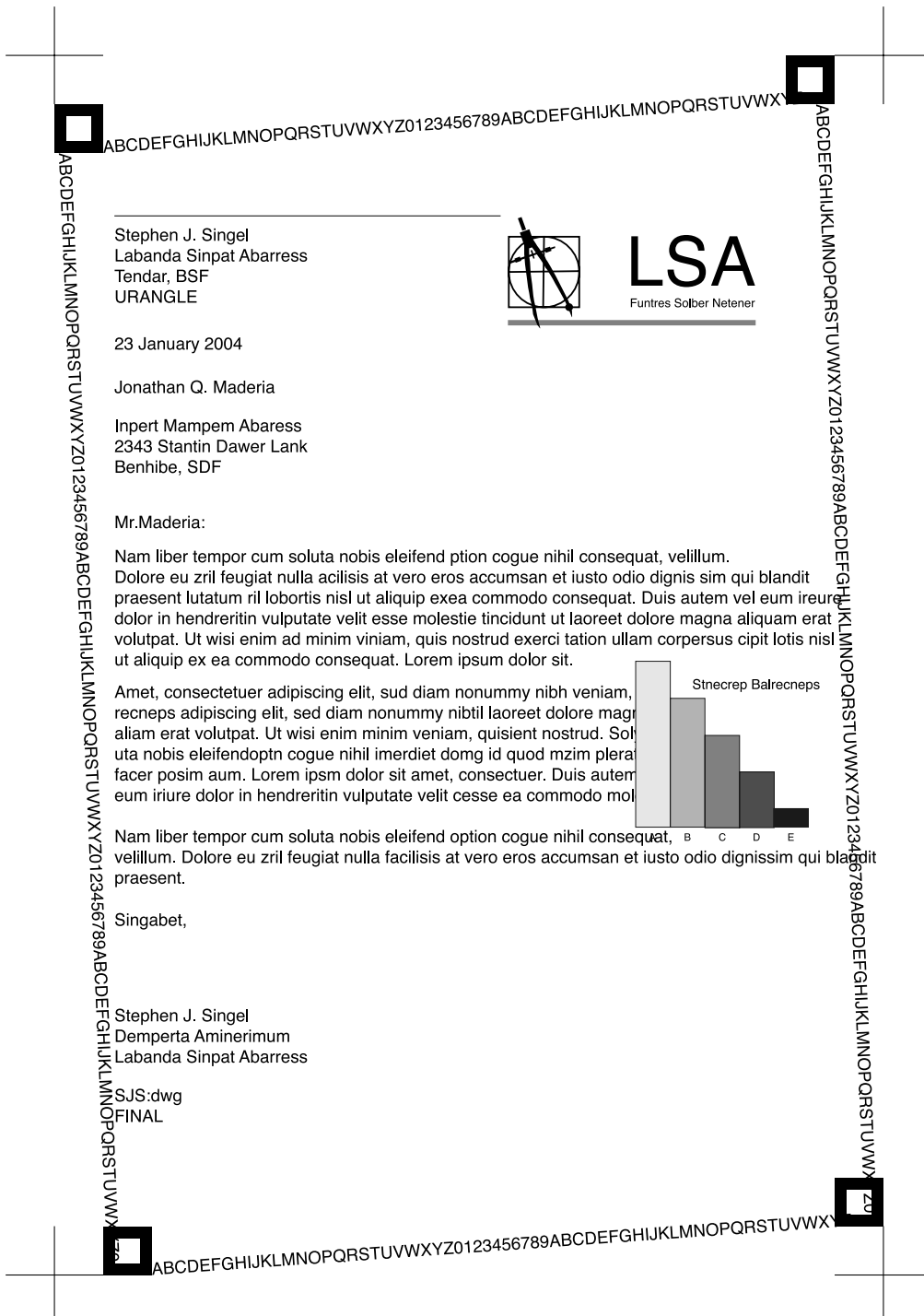

6.4 Selecting a location

Select a level, stable place with adequate space for air circulation. Allow extra space for opening covers and trays.

The area should be well-ventilated and away from direct sunlight or sources of heat, cold, and humidity. Do not set the machine close to the edge of your desk or table.

Clearance space

- Front: 482.6 mm (enough space so that the paper tray can be removed)
- Back: 100 mm (enough space for ventilation)
- Right: 100 mm (enough space for ventilation)
- Left: 100 mm (enough space for ventilation)

