



Mono Laser Printer

ML-216x series

ML-216x / ML-216xW

SERVICE MANUAL

Mono Laser Printer

Contents



1. Precautions
2. Product Specifications and Description
3. Disassembly and Reassembly
4. Alignment and Troubleshooting
5. System Diagram
6. Reference Information

Refer to the service manual in the GSPN (see the rear cover) for more information.

Contents

- 1. Precautions 1 – 1
 - 1.1. Safety warning 1 – 1
 - 1.2. Caution for safety 1 – 2
 - 1.2.1. Toxic material 1 – 2
 - 1.2.2. Electric shock and fire safety precautions 1 – 2
 - 1.2.3. Handling precautions 1 – 3
 - 1.2.4. Assembly and Disassembly precautions 1 – 3
 - 1.2.5. Disregarding this warning may cause bodily injury 1 – 4
 - 1.3. ESD precautions 1 – 5
- 2. Product Specifications and Description 2 – 1
 - 2.1. Product Specifications 2 – 1
 - 2.1.1. Product Overview 2 – 1
 - 2.1.2. Specifications 2 – 1
 - 2.1.2.1. General Print Engine 2 – 1
 - 2.1.2.2. Controller and Software 2 – 2
 - 2.1.2.3. Paper Handling 2 – 3
 - 2.1.2.4. Consumables 2 – 3
 - 2.1.2.5. Maintenance Part 2 – 4
 - 2.1.2.6. Reliability and Service 2 – 4
 - 2.1.2.7. Environment 2 – 4
 - 2.1.2.8. Accessories 2 – 5
 - 2.1.3. Model Comparison Table 2 – 6
 - 2.2. System Overview 2 – 7
 - 2.2.1. Front View 2 – 7
 - 2.2.2. Rear View 2 – 8
 - 2.2.3. Paper Path 2 – 9
 - 2.2.4. System Layout 2 – 10
 - 2.2.4.1. Feeding Part 2 – 11
 - 2.2.4.2. Transfer Roller 2 – 12
 - 2.2.4.3. Drive Unit 2 – 12
 - 2.2.4.4. Fuser Unit 2 – 13
 - 2.2.4.5. LSU (Laser Scanner Unit) 2 – 15
 - 2.2.4.6. Toner Cartridge 2 – 16
 - 2.2.5. Hardware configuration 2 – 17
 - 2.2.5.1. Main board 2 – 18
 - 2.2.5.2. OPE board 2 – 20
 - 2.2.5.3. Wireless LAN board (ML-216xW only) 2 – 21
 - 2.2.5.4. SMPS/HVPS board 2 – 22

2.2.5.5.	Electrical Parts Location	2 – 24
2.2.6.	Engine F/W Contol Algorithm	2 – 25
2.2.6.1.	Feeding	2 – 25
2.2.6.2.	Transfer.....	2 – 25
2.2.6.3.	Fusing.....	2 – 26
2.2.6.4.	LSU.....	2 – 26
2.2.7.	Software Descriptions	2 – 27
2.2.7.1.	Software system overview	2 – 27
2.2.7.2.	Architecture	2 – 27
2.2.7.3.	Data and Control Flow	2 – 28
3.	Disassembly and Reassembly	3 – 1
3.1.	Precautions when replacing parts	3 – 1
3.1.1.	Precautions when assembling and disassembling	3 – 1
3.1.2.	Preautions when handling PBA	3 – 1
3.1.3.	Releasing Plastic Latches	3 – 2
3.2.	Screws used in the printer.....	3 – 3
3.3.	Replacing the Main SVC parts	3 – 4
3.3.1.	Cover.....	3 – 4
3.3.2.	Main board.....	3 – 6
3.3.3.	Fuser Unit.....	3 – 6
3.3.4.	SMPS/HVPS board.....	3 – 7
3.3.5.	Drive Unit.....	3 – 7
3.3.6.	LSU.....	3 – 8
3.3.7.	Feed Sensor PBA	3 – 9
3.3.8.	Pick up roller	3 – 9
3.3.9.	Motor.....	3 – 10
3.3.10.	Transfer roller.....	3 – 11
4.	Alignment and Troubleshooting	4 – 1
4.1.	Alignment and Adjustments.....	4 – 1
4.1.1.	Control Panel.....	4 – 1
4.1.2.	Understanding the status LED.....	4 – 3
4.1.3.	Jam Removal.....	4 – 4
4.1.4.	Periodic Defective Image	4 – 6
4.1.5.	Useful management tools.....	4 – 7
4.1.5.1.	Using Samsung Easy Printer Manager (Windows and Macintosh only).....	4 – 7
4.1.5.2.	Using Samsung Printer Status (Windows only)	4 – 9
4.1.5.3.	Using Smart Panel (Linux only).....	4 – 10
4.1.5.4.	Using SyncThru Web Service (SWS)	4 – 11
4.1.6.	Updating Firmware.....	4 – 13
4.1.6.1.	Update the firmware by using the USB port.....	4 – 13

- 4.1.6.2. Update the firmware by using the network (ML-216xW only)..... 4 – 14
- 4.2. Troubleshooting 4 – 16
 - 4.2.1. Procedure of checking the symptoms..... 4 – 16
 - 4.2.1.1. Basic Check List 4 – 17
 - 4.2.2. Error Code and Troubleshooting..... 4 – 18
 - 4.2.3. Image quality problem..... 4 – 25
 - 4.2.4. Other errors..... 4 – 31
- 5. System Diagram..... 5 – 1
 - 5.1. Block Diagram..... 5 – 1
 - 5.2. Connection Diagram..... 5 – 2
- 6. Reference Information..... 6 – 1
 - 6.1. Tool for Troubleshooting..... 6 – 1
 - 6.2. Glossary..... 6 – 2
 - 6.3. The Sample Pattern for the Test 6 – 8
 - 6.4. Selecting a location 6 – 9

1. Precautions

1.1. Safety warning

- 1) Only to be serviced by a factory trained service technician.

High voltages and lasers inside this product are dangerous. This product should only be serviced by a factory trained service technician.

- 2) Use only Samsung replacement parts.

There are no user serviceable parts inside the product. Do not make any unauthorized changes or additions to the product as these could cause the product to malfunction and create an electric shocks or fire hazards.

- 3) Laser Safety Statement

The printer is certified in the U.S. to conform to the requirements of DHHS 21 CFR, chapter 1 Subchapter J for Class I(1) laser products, and elsewhere is certified as a Class I laser product conforming to the requirements of IEC 60825-1. Class I laser products are not considered to be hazardous. The laser system and printer are designed so there is never any human access to laser radiation above a Class I level during normal operation, user maintenance or prescribed service condition.

- Wavelength: Max. 800 nm (785 -10/+15)
- Beam divergence
 - Parallel: Max. 13 degrees (10 -4/+3)
 - Perpendicular: Max. 35 degrees (31 -6/+4)
- Maximum power of energy output: 12 mW



WARNING

Never operate or service the product with the protective cover removed from Laser/Scanner assembly. The reflected beam, although invisible, can damage your eyes.

When using this product, these basic safety precautions should always be followed to reduce risk of fire, electric shock, and personal injury.



CAUTION - CLASS 3B LASER RADIATION WHEN OPEN
AVOID EXPOSURE TO THE BEAM.

DANGER - LASER RADIATION AVOID DIRECT
EXPOSURE TO BEAM.

DANGER - RADIATIONS INVISIBLES DU LASER EN CAS
D'OUVERTURE. EVITER TOUTE EXPOSITION
DIRECTE AU FAISCEAU.

VORSICHT - UNSICHTBARE LASERSTRAHLUNG, WENN
ABDECKUNG GEÖFFNET.
NICHT DEM STRAHL AUSSETZEN.

ATTENZIONE - RADIAZIONE LASER INVISIBILE IN CASO DI
APERTURA. EVITARE L'ESPOSIZIONE AL FASCIO.

PRECAUCIÓN - RADIACIÓN LASER INVISIBLE CUANDO SE ABRE.
EVITAR EXPONERSE AL RAYO.

PERIGO - RADIAÇÃO LASER INVISÍVEL AO ABRIR. EVITE
EXPOSIÇÃO DIRECTA AO FEIXE.

GEVAAR - ONZICHTBARE LASERSTRALEN BIJ GEOPENDE
KLEP. DEZE KLEP NIET OPENEN.

ADVARSEL - USYNLIG LASERSTRÅLNING VED ÅBNING.
UNDGÅ UDSÆTTELSE FOR STRÅLNING.

ADVARSEL - USYNLIG LASERSTRÅLNING NÅR DEKSEL
ÅPNES. UNNGÅ EKSPONERING FOR STRÅLEN.

VARNING - OSYNLIG LASERSTRÅLNING NÅR DENNA DEL
ÄR ÖPPEN. STRÅLEN ÄR FARLIG.

VAROITUS - NÄKYMÄTÖNTÄ LASERSÄTEILYÄ AVATTAESSA.
VARO SUORAA ALTISTUMISTA SÄTEELLE.

注意 - 严禁揭开此盖, 以免激光泄露灼伤

주의 - 이 덮개를 열면 레이저광에 노출될 수 있으므로
주의하십시오.

1.2. Caution for safety

1.2.1. Toxic material

This product contains toxic materials that could cause illness if ingested.

- 1) Please keep imaging unit and toner cartridge away from children. The toner powder contained in the imaging unit and toner cartridge may be harmful, and if swallowed, you should contact a doctor.

1.2.2. Electric shock and fire safety precautions

Failure to follow the following instructions could cause electric shock or potentially cause a fire.

- 1) Use only the correct voltage, failure to do so could damage the product and potentially cause a fire or electric shock.
- 2) Use only the power cable supplied with the product. Use of an incorrectly specified cable could cause the cable to overheat and potentially cause a fire.
- 3) Do not overload the power socket, this could lead to overheating of the cables inside the wall and could lead to a fire.
- 4) Do not allow water or other liquids to spill into the product, this can cause electric shock. Do not allow paper clips, pins or other foreign objects to fall into the product, these could cause a short circuit leading to an electric shock or fire hazard.
- 5) Never touch the plugs on either end of the power cable with wet hands, this can cause electric shock. When servicing the product, remove the power plug from the wall socket.
- 6) Use caution when inserting or removing the power cord. When removing the power cord, grip it firmly and pull. The power cord must be inserted completely, otherwise a poor contact could cause overheating leading to a fire.
- 7) Take care of the power cable. Do not allow it to become twisted, bent sharply around corners or power cable may be damaged. Do not place objects on top of the power cable. If the power cable is damaged it could overheat and cause a fire. Exposed cables could cause an electric shock. Replace the damaged power cable immediately, do not reuse or repair the damaged cable. Some chemicals can attack the coating on the power cable, weakening the cover or exposing cables causing fire and shock risks.
- 8) Ensure that the power sockets and plugs are not cracked or broken in any way. Any such defects should be repaired immediately. Take care not to cut or damage the power cable or plugs when moving the machine.
- 9) Use caution during thunder or lightning storms. Samsung recommends that this machine be disconnected from the power source when such weather conditions are expected. Do not touch the machine or the power cord if it is still connected to the wall socket in these weather conditions.
- 10) Avoid damp or dusty areas, install the product in a clean well ventilated location. Do not position the machine near a humidifier or in front of an air conditioner. Moisture and dust built up inside the machine can lead to overheating and cause a fire or cause parts to rust.
- 11) Do not position the product in direct sunlight. This will cause the temperature inside the product to rise possibly leading to the product failing to work properly and in extreme conditions could lead to a fire.
- 12) Do not insert any metal objects into the machine through the ventilator fan or other part of the casing, it could make contact with a high voltage conductor inside the machine and cause an electric shock.
- 13)  When replacing the SMPS board, please wait 5 minutes after unplugging the power cord, then replace it. You can get a shock by the electric discharge.

1.2.3. Handling precautions

The following instructions are for your own personal safety to avoid injury and so as not to damage the product.

- 1) Ensure the product is installed on a level surface, capable of supporting its weight. Failure to do so could cause the product to tip or fall.
- 2) The product contains many rollers, gears and fans. Take great care to ensure that you do not catch your fingers, hair or clothing in any of these rotating devices.
- 3) Do not place any small metal objects, containers of water, chemicals or other liquids close to the product which if spilled could get into the machine and cause damage or a shock or fire hazard.
- 4) Do not install the machine in areas with high dust or moisture levels, beside an open window or close to a humidifier or heater. Damage could be caused to the product in such areas.
- 5) Do not place candles, burning cigarettes, etc on the product, These could cause a fire.

1.2.4. Assembly and Disassembly precautions

- 1) Replace parts carefully and always use Samsung parts. Take care to note the exact location of parts and also cable routing before dismantling any part of the machine. Ensure all parts and cables are replaced correctly. Please carry out the following procedures before dismantling the product or replacing any parts.
- 2) Ensure that power is disconnected before servicing or replacing any electrical parts.
- 3) Disconnect interface cables and power cables.
- 4) Only use approved spare parts. Ensure that part number, product name, any voltage, current or temperature rating are correct.
- 5) When removing or re-fitting any parts do not use excessive force, especially when fitting screws into plastic.
- 6) Take care not to drop any small parts into the machine.
- 7) Handling of the OPC Drum
 - The OPC Drum can be irreparably damaged if it is exposed to light. Take care not to expose the OPC Drum either to direct sunlight or to fluorescent or incandescent room lighting. Exposure for as little as 5 minutes can damage the surface of the photoconductive properties and will result in print quality degradation. Take extra care when servicing the product. Remove the OPC Drum and store it in a black bag or other lightproof container. Take care when working with the Covers (especially the top cover) open as light is admitted to the OPC area and can damage the OPC Drum.
 - Take care not to scratch the green surface of the OPC Drum Unit. If the green surface of the Drum Cartridge is scratched or touched the print quality will be compromised.

1.2.5. Disregarding this warning may cause bodily injury

- 1) Be careful with the high temperature part.

The fuser unit works at a high temperature. Use caution when working on the printer. Wait for the fuser unit to cool down before disassembly.

- 2) Do not put fingers or hair into the rotating parts.

When operating a printer, do not put hand or hair into the rotating parts (Paper feeding entrance, motor, fan, etc.). If do, you can get harm.

- 3) When you move the printer, use safe lifting and handling techniques.

This printer is heavy. Use the lifting handles located on each side of the machine. Back injury could be caused if you do not lift carefully.

- 4) Ensure the printer is installed safely.

Ensure the printer is installed on a level surface, capable of supporting its weight. Failure to do so could cause the printer to tip or fall possibly causing personal injury or damaging the printer.

- 5) Do not install the printer on a sloping or unstable surface. After installation, double check that the printer is stable.

1.3. ESD precautions

Certain semiconductor devices can be easily damaged by static electricity. Such components are commonly called “Electrostatically Sensitive (ES) Devices” or ESDs. Examples of typical ESDs are: integrated circuits, some field effect transistors, and semiconductor “chip” components. The techniques outlined below should be followed to help reduce the incidence of component damage caused by static electricity.



CAUTION

Be sure no power is applied to the chassis or circuit, and observe all other safety precautions.

- 1) Immediately before handling a semiconductor component or semiconductor-equipped assembly, drain off any electrostatic charge on your body by touching a known earth ground. Alternatively, employ a commercially available wrist strap device, which should be removed for your personal safety reasons prior to applying power to the unit under test.
- 2) After removing an electrical assembly equipped with ESDs, place the assembly on a conductive surface, such as aluminum or copper foil, or conductive foam, to prevent electrostatic charge buildup in the vicinity of the assembly.
- 3) Use only a grounded tip soldering iron to solder or desolder ESDs.
- 4) Use only an “anti-static” solder removal device. Some solder removal devices not classified as “anti-static” can generate electrical charges sufficient to damage ESDs.
- 5) Do not use Freon-propelled chemicals. When sprayed, these can generate electrical charges sufficient to damage ESDs.
- 6) Do not remove a replacement ESD from its protective packaging until immediately before installing it. Most replacement ESDs are packaged with all leads shorted together by conductive foam, aluminum foil, or a comparable conductive material.
- 7) Immediately before removing the protective shorting material from the leads of a replacement ESD, touch the protective material to the chassis or circuit assembly into which the device will be installed.
- 8) Maintain continuous electrical contact between the ESD and the assembly into which it will be installed, until completely plugged or soldered into the circuit.
- 9) Minimize bodily motions when handling unpackaged replacement ESDs. Normal motions, such as the brushing together of clothing fabric and lifting one’s foot from a carpeted floor, can generate static electricity sufficient to damage an ESD.

2. Product Specifications and Description

2.1. Product Specifications

2.1.1. Product Overview

	<ol style="list-style-type: none"> 1) Speed <ul style="list-style-type: none"> • Up to 20 ppm in A4 (21 ppm in Letter) 2) Processor <ul style="list-style-type: none"> • 300 MHz 3) Printer Languages <ul style="list-style-type: none"> • SPL (Samsung Printer Language) 4) Memory <ul style="list-style-type: none"> • ML-216x : 8 MB • ML-216xW : 32 MB 5) Interface <ul style="list-style-type: none"> • Hi-Speed USB 2.0 • Network Interface 802.11b/g/n wireless LAN (Only ML-216xW) 6) Toner Cartridges <ul style="list-style-type: none"> • Initial : 0.7 K • Sales : 1.5 K
--	--

2.1.2. Specifications

Product Specifications are subject to change without notice. See below for product specifications.

2.1.2.1. General Print Engine

Item		Specification
Engine Speed	Simplex	Up to 20 ppm in A4 (21 ppm in Letter)
	Duplex	Manual Duplex
Warm-up time	From Sleep	Less than 30 seconds
FPOT	From Ready	Less than 8.5 seconds
	From Sleep	Less than 15.5 seconds
Resolution		Up to 1,200 x 1,200 dpi effective output

2.1.2.2. Controller and Software

Item		Specification
Processor		300 MHz
Memory	Std.	<ul style="list-style-type: none"> • ML-216x : 8 MB • ML-216xW : 32 MB
	Optional	N/A
Printer Languages		SPL (Samsung Printer Language)
Fonts		Windows Fonts
Driver	Default Driver	SPL (Samsung Printer Language)
	Install	SPL (Samsung Printer Language)
	Supporting OS	Windows 2000/ XP(32/64bits)/ Vista(32/64bits)/ 2003 Server(32/64bits)/ 2008 Server(32/64bits)/ 7(32/64bits)/ 2008 Server R2(64bits)
		<ul style="list-style-type: none"> • Various Linux OS <ul style="list-style-type: none"> • RedHat Enterprise Linux WS 4, 5 (32/64 bit) • Fedora 5, 6, 7, 8, 9, 10, 11, 12, 13 (32/64 bit) • SuSE Linux 10.1 (32 bit) • OpenSUSE 10.2, 10.3, 11.0, 11.1, 11.2 (32/64 bit) • Mandriva 2007, 2008, 2009, 2009.1, 2010 (32/64 bit) • Ubuntu 6.06, 6.10, 7.04, 7.10, 8.04, 8.10, 9.04, 9.10, 10.04 (32/64 bit) • SuSE Linux Enterprise Desktop 10, 11 (32/64 bit) • Debian 4.0, 5.0 (32/64 bit)
		Mac OS X 10.4~10.7
	WHQL	Windows Vista(32/64bits)/ Win7(32/64bits)/ 2003 Server(32/64bits)
	Compatibility	Windows 2000/ XP(32/64bits)/ Vista(32/64bits)/ 2003 Server(32/64bits)/ 2008 Server(32/64bits)/ 7(32/64bits)/ 2008 Server R2(64bits)
Interface	Parallel	N/A
	USB	Hi-Speed USB 2.0
	Wired Network	N/A
	Wireless Network	Network Interface 802.11b/g/n wireless LAN
Application	Samsung AnyWeb	Windows and Macintosh OS only
	Samsung Easy Printer Manager	Windows and Macintosh OS only
	Samsung Printer Status	Windows OS only
	Smart Panel	Linux OS only

2.1.2.3. Paper Handling

Item		Specification
Standard Capacity		150-sheet Multi Purpose Tray @ 80 g/m ²
Max. Capacity		150-sheet @ 80 g/m ²
Printing	Max. Size	216 x 356 mm (8.5" x 14.02")
	Min. Size	76 x 183 mm (3.0" x 7.2")
Standard Cassette Tray		N/A
Multi-purpose Tray (Bin type)	Capacity	<ul style="list-style-type: none"> Plain Paper : 150 sheets @ 80 g/m² Envelop : 1 sheet @ 80 g/m²
	Media sizes	A4, A5, Letter, Legal, Executive, Folio, Oficio, ISO B5, JIS B5, Envelope(Monarch, No.10, DL, C5), Custom
	Media type	Plain, Thin, Cotton, Recycled, Archive, Colored, Pre-Printed, Label, Bond, Thick, Envelopes, Cardstock
	Media weight	16~43 lb (60 to 163 g/m ²)
	Sensing	N/A
Optional Cassette Tray		N/A
Output Stacking	Capacity	<ul style="list-style-type: none"> Face-Down : 100 sheets @ 80 g/m²
	Output Full sensing	N/A
Duplex	Supporting	Yes (manual)
	Media sizes	A4, A5, Letter, Legal, Executive, Folio, Oficio, ISO B5, JIS B5, Custom
	Media types	Plain, Thin, Recycled, Archive,
	Media weight	16~24 lb (60 to 90 g/m ²)
Printable Area	Non-Printable Area	<ul style="list-style-type: none"> 3 mm (0.12") from edge (Top, Bottom, Left, Right)

2.1.2.4. Consumables

Item		Specification
Toner Cartridge	Part name	MLT-D101S
	Average yield	<ul style="list-style-type: none"> Average Cartridge Yield 1,500 standard pages (Ships with 700 pages Starter Toner Cartridge) <div style="background-color: #cccccc; padding: 5px; margin-top: 10px;">  NOTE Declared yield value in accordance with ISO/IEC 19752. </div>

 **NOTE**

Depending on the options, percentage of image area, and job mode used, the toner cartridge's lifespan may differ.

2.1.2.5. Maintenance Part

Item	Part Code	Life
Fuser Unit	<ul style="list-style-type: none"> • JC91-01075A (220V) • JC91-01074A (110V) 	30,000 Pages
Transfer Roller	JC66-02709A	30,000 Pages
Pick-Up Roller (Assy)	JC93-00525A	30,000 Pages
Feed Roller	JC66-02598B	30,000 Pages

2.1.2.6. Reliability and Service

Items	Specification
Printing Volume (SET AMPV)	75 sheets/month
MPBF	20,000 sheets
MTRR	30 min.
SET Life Cycle	30,000 sheets or 5 years (whichever comes first)

2.1.2.7. Environment

Item	Specification	
Dimension (W x D x H)	Machine	332 x 215 x 178 mm (13.07 x 8.46 x 7.01 inches)
Weight	Machine with toner cartridge	3.88 kg (8.55 lbs)
Noise Level*	Ready mode	Less than 30 dB (A)
	Print mode	Less than 50 dB (A)
Temperature	Operation	10 ~ 32 °C (50 ~ 90 °F)
Humidity	Operation	20 ~ 80% RH
Power rating**	110 volt models	AC 110 - 127 V
	220 volt models	AC 220 - 240 V
Power Consumption	Average operating mode	Less than 230 W
	Ready mode	Less than 35 W
	Power save mode	Less than 1.0 W
	Power off mode	Less than 0.45 W (0.1 W***)

* Sound Pressure Level, ISO 7779. Configuration tested: basic machine installation, A4 paper, simplex printing.



** See the rating label on the machine for the correct voltage (V), frequency (hertz) and type of current (A) for your machine.

*** For the machine that has a power switch.

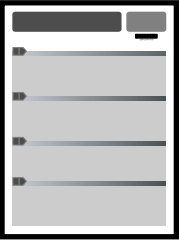
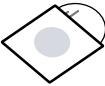
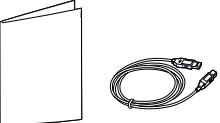
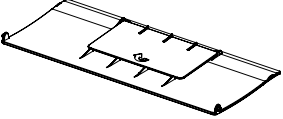
2.1.2.8. Accessories

Image	Item	Remark
	Power cord	
	Quick installation guide	
	Software CD	The software CD contains the printer drivers and software applications.
	Misc. accessories	Miscellaneous accessories included with your machine may vary by country of purchase and specific model.
	Stacker	

2.1.3. Model Comparison Table

	Samsung ML-216x	Samsung ML-167x	HP P1505n
Image			
Speed	20 ppm (A4)	16 ppm (A4)	18 ppm (A4)
Processor	300 MHz	300 MHz	266 MHz
Memory	8 MB	8 MB	2 MB
Print Language	SPL	SPL	PCL5e
Input	150 sheets Bin	150 sheets Bin	150 sheets Bin
Duplex	Manual	Manual	Manual
Interface	High Speed USB 2.0	High Speed USB 2.0	High Speed USB 2.0
Size (mm)	332 x 215 x 178 mm	341 x 224 x 184 mm	349 x 238 x 196 mm
Toner	Standard 1.5K	Standard 1.5K	Standard 1.6K

2.2. System Overview

This chapter describes the functions and operating principal of the main component.

2.2.1. Front View

NOTE

- This illustration may differ from your machine depending on its model.
- Some features and optional goods may not be available depending on model or country.

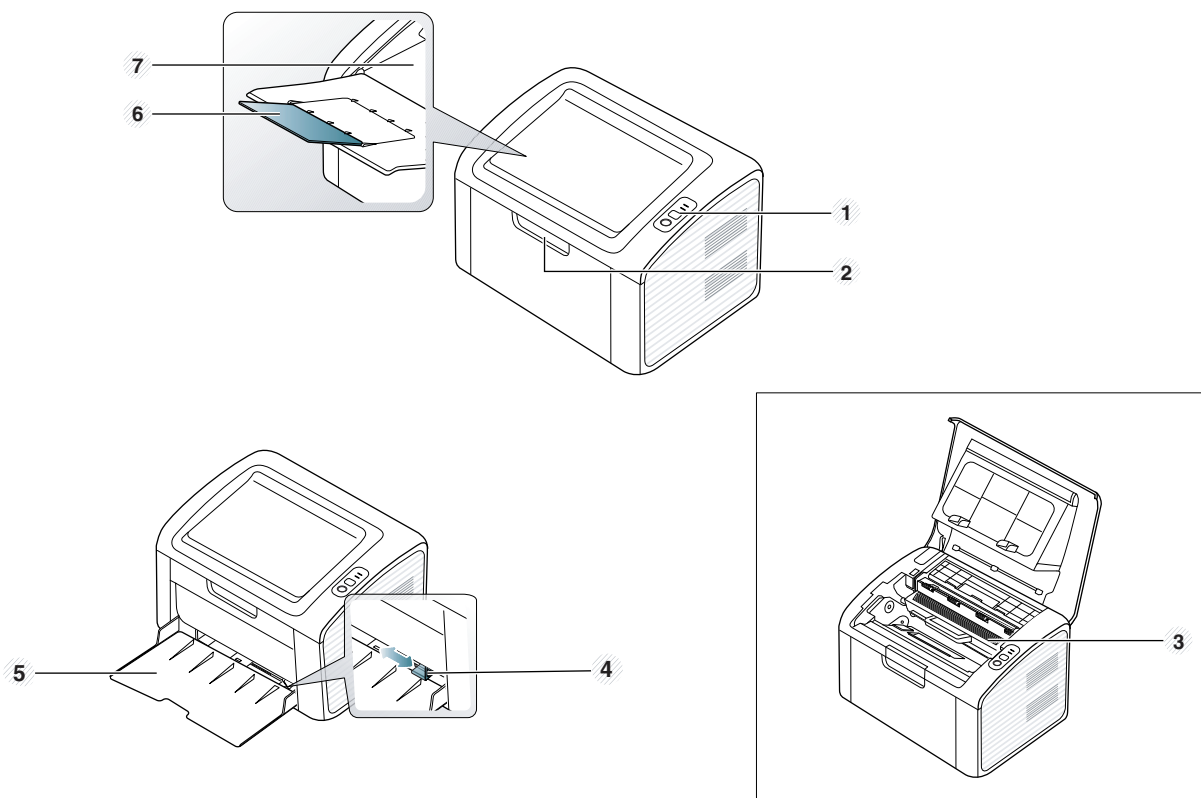

1	Control panel
2	Top cover
3	Toner cartridge
4	Paper width guides
5	Tray

6	Output tray
7	Output support

2.2.2. Rear View

 **NOTE**

- This illustration may differ from your machine depending on its model.
- Some features and optional goods may not be available depending on model or country.

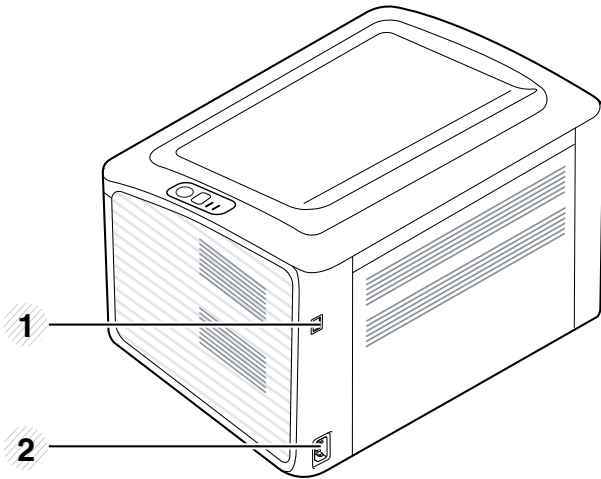

1	USB Port
2	Power receptacle

2.2.3. Paper Path

The following diagram displays the path the paper follows during the printing process.

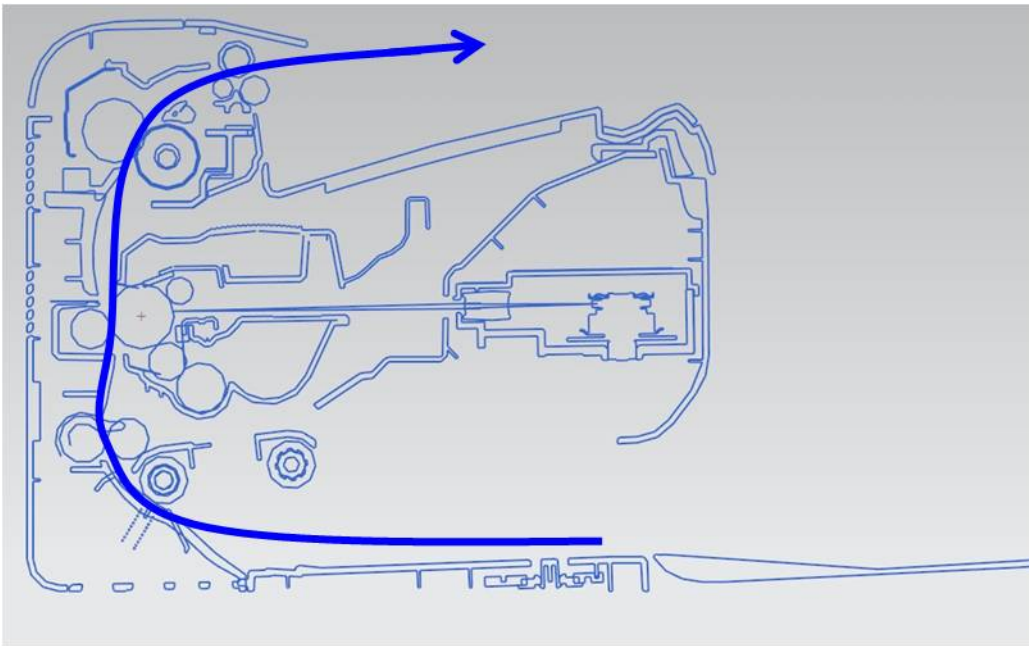

2.2.4. System Layout

This model consists of the engine parts, hardware parts, firmware. The engine parts consists of the mechanical parts comprising Frame, Toner Cartridge, Drive Unit, Transfer roller, Pick up unit, Fuser, Bin-tray. The hardware parts consists of the main board, SMPS/HVPS board, OPE board, PC interface.

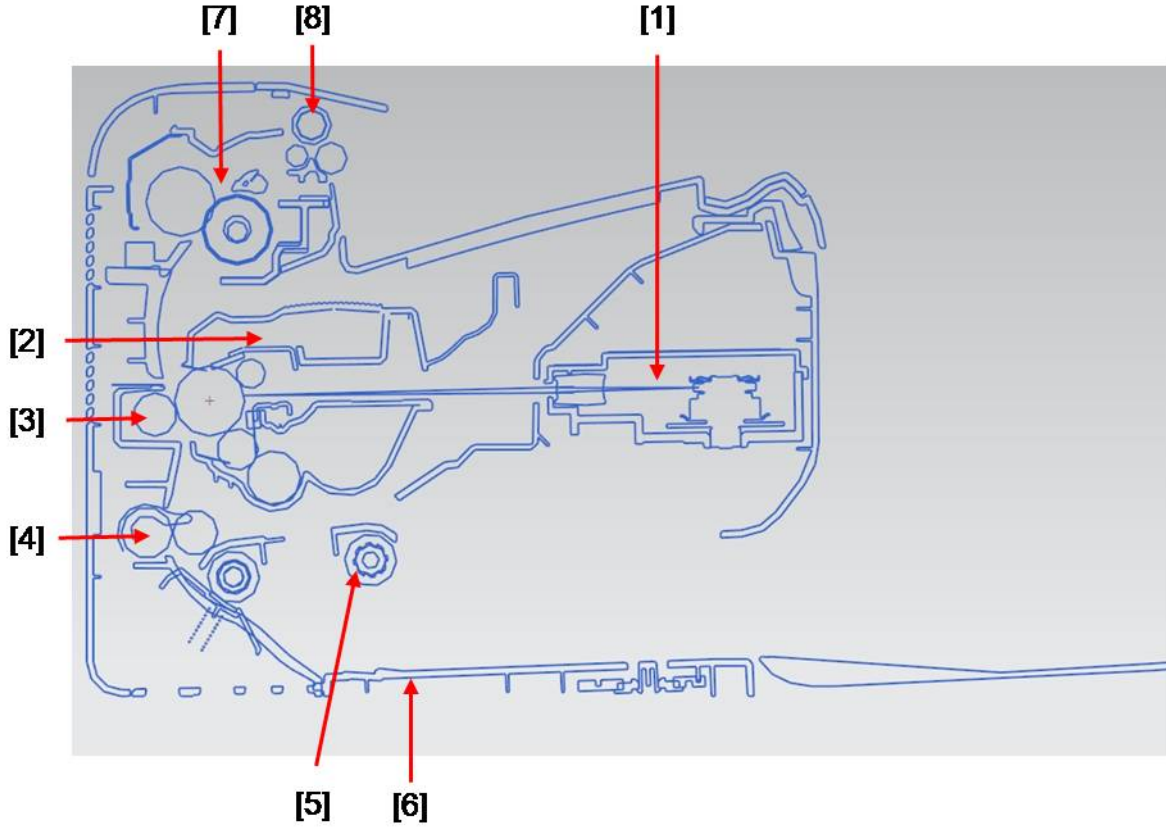

1	LSU
2	Toner Cartridge
3	Transfer roller
4	Feed roller
5	Pick-Up roller

6	Plate-Bottom
7	Fuser Unit
8	Exit roller1

2.2.4.1. Feeding Part

It consists of a bin-type tray, pick-up roller, friction pad and parts related to paper feed initialization.

1) Input Tray

This model has a bin-type tray.

It takes a center loading method and applies 'friction pad separating method.'

The side guide can be adjusted for various types of papers from A6 to legal size paper. It has a paper detecting function, paper arranging function.

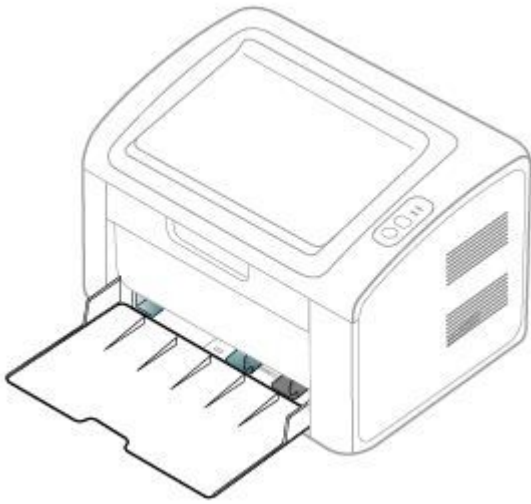

2) Pick-up roller

It has functions such as a paper pickup function, driving control function, paper feeding function, and removing electronic static function. Pick up roller is driven by clutch.

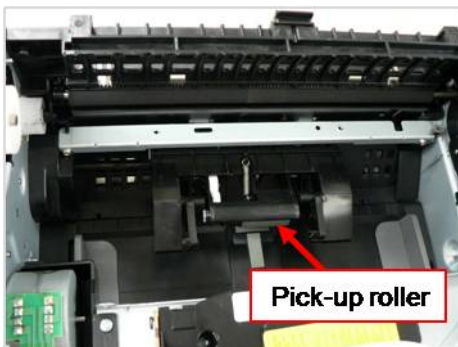

2.2.4.2. Transfer Roller

The transfer roller delivers the toner of the OPC drum to the paper.

- Life Span : Print over 30,000 sheets (in 15~30°C)



2.2.4.3. Drive Unit

In ML-216x series, the driving device consists of OPC, Pick- up, Feed, Fuser, Gear- Train connected with Mounting member. A step motor for driving is assembled to the left frame.

- Driving Frequency: Step Motor 810 PPS (1013 rpm)
- It is a power delivery unit by gearing: Step Motor → Pick-up/ Feeder/ OPC/ Fuser/ Exit

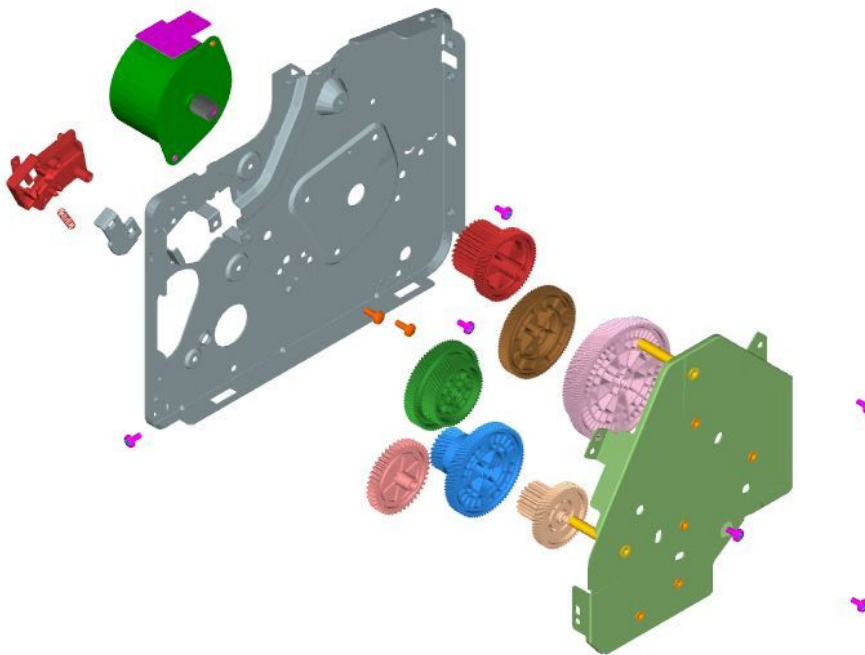

2.2.4.4. Fuser Unit

This unit consists of Heat Roller, a Thermostat, and Thermistor, etc. It fuses the toner that was transferred by the transfer roller onto the paper, by applying heat and pressure to complete fusing process.

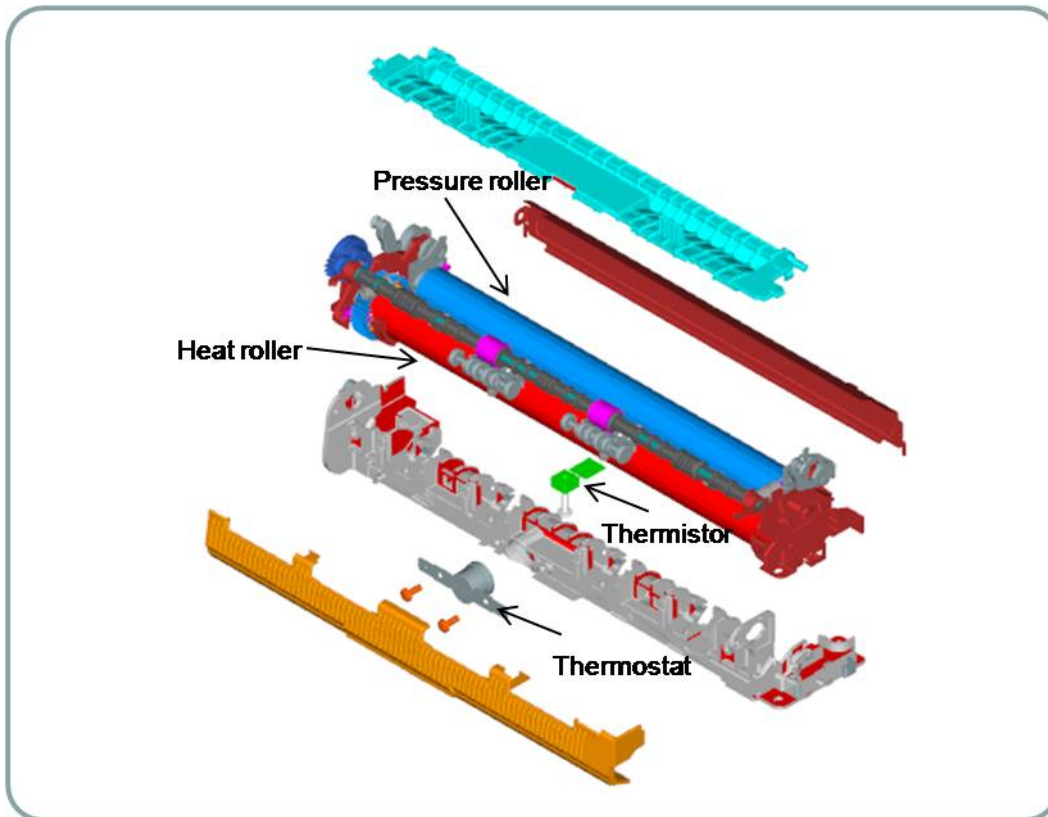

1) **Thermostat**

When a heat lamp is overheated, a Thermostat cuts off the main power to prevent over- heating.

- Thermostat Type : Non- Contact type Thermostat
- Control Temperature : $195^{\circ}\text{C} \pm 5^{\circ}\text{C}$

2) **Thermistor**

It is a temperature detecting sensor.

- Temperature Resistance : $7\text{ k}\Omega(180^{\circ}\text{C})$

3) **Heat roller**

The heat roller transfers the heat from the lamp to apply a heat on the paper.

The surface of a heat roller is coated with Teflon, so toner does not stick to the surface.

4) **Pressure roller**

A pressure roller mounted under a heat roller is made of a silicon resin, and the surface also is coated with Teflon. When a paper passes between a heat roller and a pressure roller, toner adheres to the surface of a paper and is permanently fused.

5) **Halogen Lamp**

- Voltage : $120\text{ V} (115 \pm 5 \%) / 220\text{ V} : 230 \pm 5 \%$
- Capacity : $850\text{ Watt} \pm 25\text{ W}$

6) **Items for safety**

- Protecting device for overheating
 - 1st protection device: Hardware cuts off when overheated
 - 2nd protection device: Software cuts off when overheated
 - 3rd protection device: Thermostat cuts off main power.
- **Safety device**
 - A fuser power is cut off when a front cover is opened.
 - Maintain a temperature of fuser cover's surface under 80°C for user, and attach a caution label at where customer can see easily when customer open a rear cover.

2.2.4.5. LSU (Laser Scanner Unit)

It is the core part of the LBP which switches from the video data received to the controller to the electrostatic latent image on the OPC drum by controlling laser beam, exposing OPC drum, and turning principle of polygon mirror. The OPC drum is turned with the paper feeding speed. The HSYNC signal is created when the laser beam from LSU reaches the end of the polygon mirror, and the signal is sent to the controller. The controller detects the HSYNC signal to adjust the vertical line of the image on paper. In other words, after the HSYNC signal is detected, the image data is sent to the LSU to adjust the left margin on paper. The one side of the polygon mirror is one line for scanning.

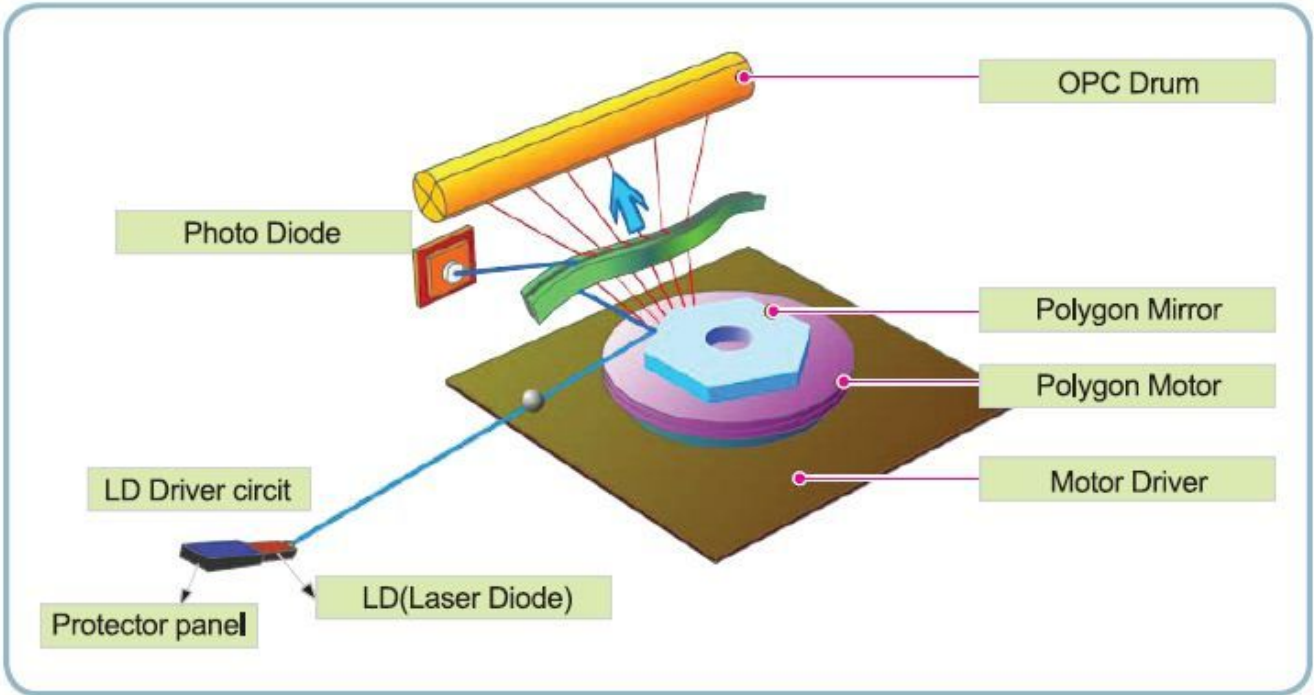

2.2.4.6. Toner Cartridge

By using the electronic photo process, it creates a visual image. In the toner cartridge, the OPC unit and the developing unit are in a body. The OPC unit has OPC drum and charging roller, and the developing unit has toner, supply roller, developing roller, and blade.

- Developing Method : Non magnetic single component non-contacting method
- Toner : Non magnetic single component pulverized type toner
- The life span of toner (ISO 19752 pattern / A4 standard)
 - Initial toner : 0.7 K
 - Sales toner : 1.5K
- OPC Cleaning : Collect the toner by using cleaning blade
- Handling of wasted toner : Collect the wasted toner in the cleaning frame by using cleaning blade
- Classifying device for toner cartridge: ID is classified by CRUM

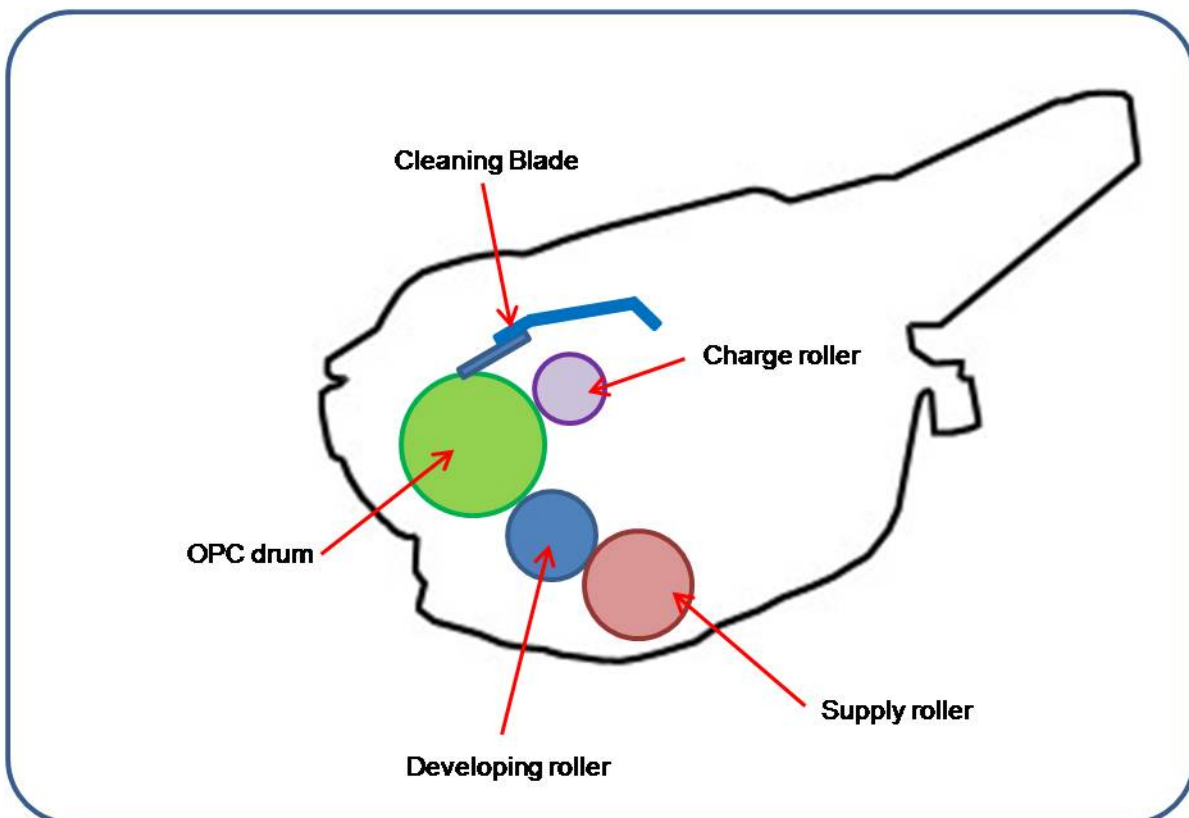

2.2.5. Hardware configuration

The ML-216x series Electrical Circuit System consists of the following:

- Main board (System board)
- OPE board
- HVPS/SMPS board
- Wireless board (Only ML-216xW)

Diagram of the ML-216x series Electrical Circuit

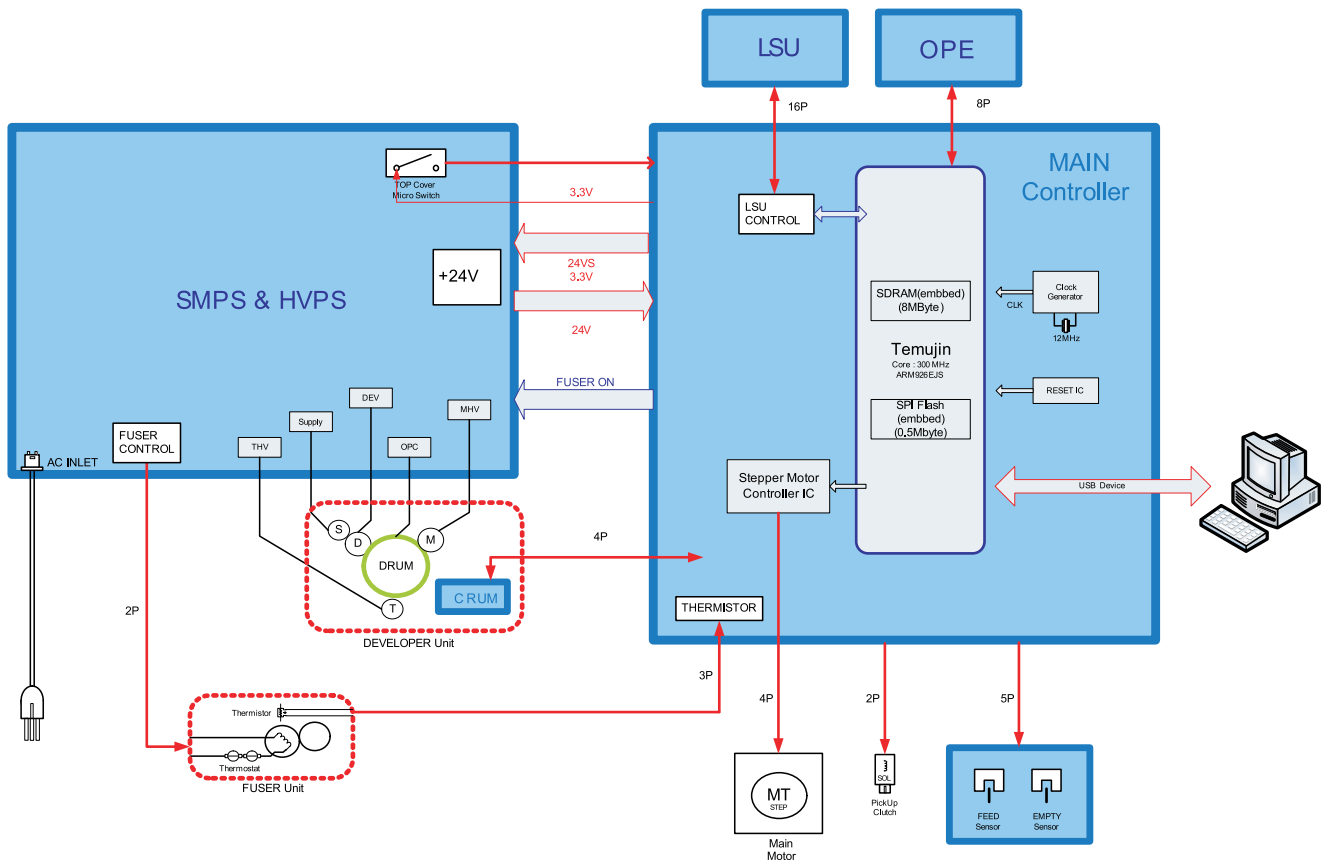

ML-216x series has a system board of integrated engine controller and video controller.

The engine controller controls all modules required to print, that is, LSU, HVPS/SMPS, Fuser, Motor etc. It communicates with the video control block inside CPU for printing. And it has the interface for all video sync signal to print out the video data.

The video controller receives print data from the host through network or USB Port. It takes this information and generates printable video bitmap data.

The main board is adopted 300 MHz TEMUJIN CPU that is integrated with engine controller, video controller, SDRAM, Flash ROM. It uses SDRAM and Flash ROM inside the ASIC chip.

2.2.5.1. Main board

TEMUJIN chip (TEMUJIN-C : wireless model) is applied to the main processor. Its process speed is 300 MHz.

It is integrated engine controller, video controller, SDRAM, Flash ROM.

For ML-216x, the internal Flash ROM is applied to Boot. For ML-216xW, the external Flash ROM is applied to Boot.

USB is the embedded type.

[Main board diagram]

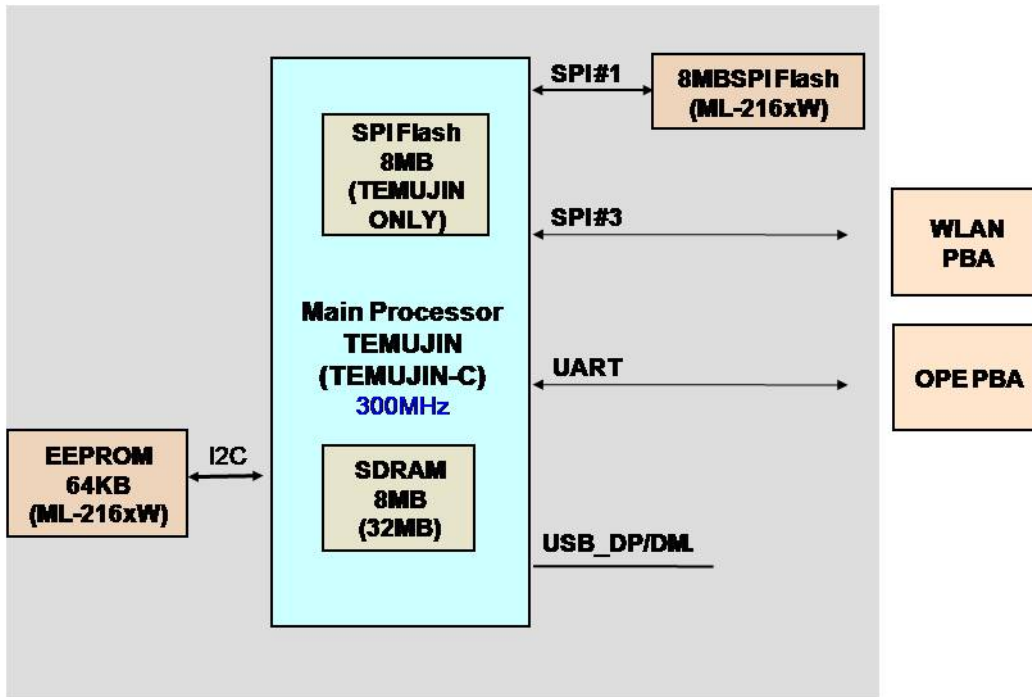

[Main board image]

- ML-216x

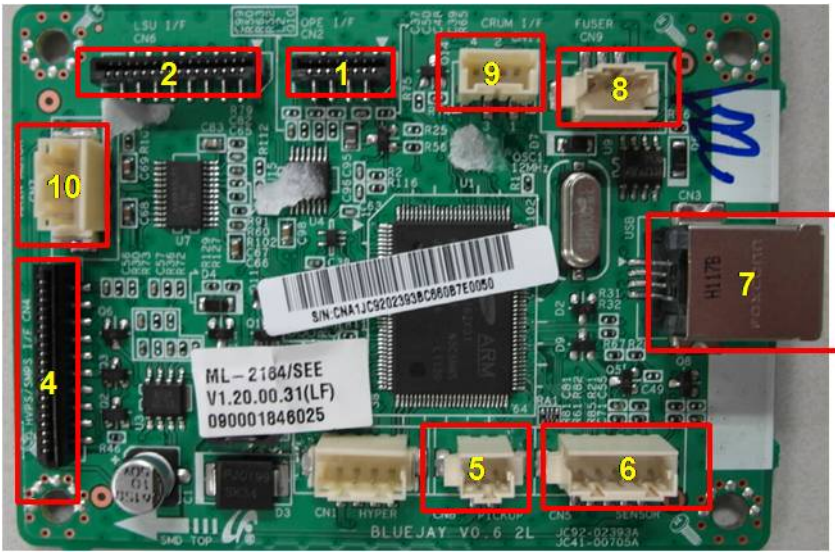

- ML-216xW (Wireless Model)

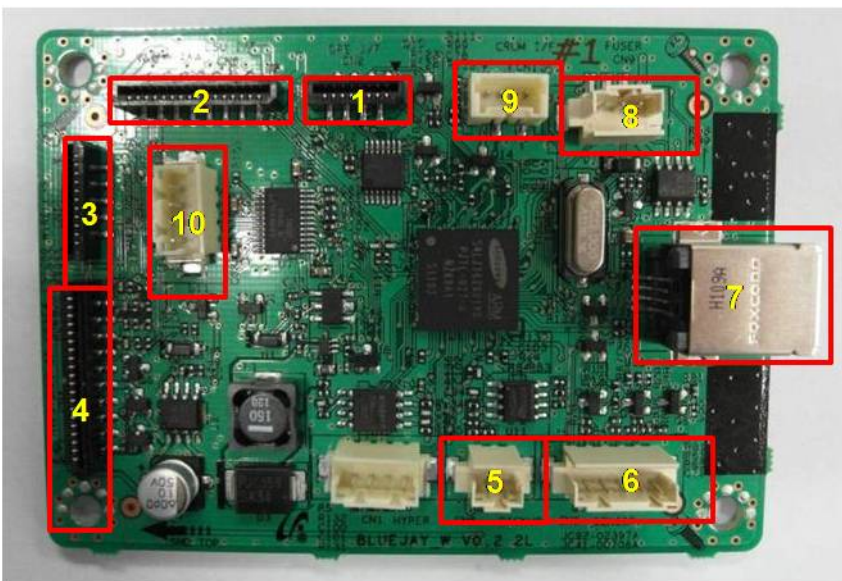

• Connection

1	OPE connector
2	LSU connector
3	Wireless module interface connector
4	SMPS/HVPS interface connector
5	Pick up connector
6	Sensor connector

7	USB device connector
8	Fuser thermistor interface connector
9	CRUM connector
10	Engint motor connector

• Information

- Part Code : JC92-02393A (ML-216x) / JC92-02397A (ML-216xW)
- Part Name : PBA-MAIN

2.2.5.2. OPE board

The OPE board is not a controller. It receives the KEY input from ASIC. LED on/off also is controlled by ASIC.

[OPE board image]

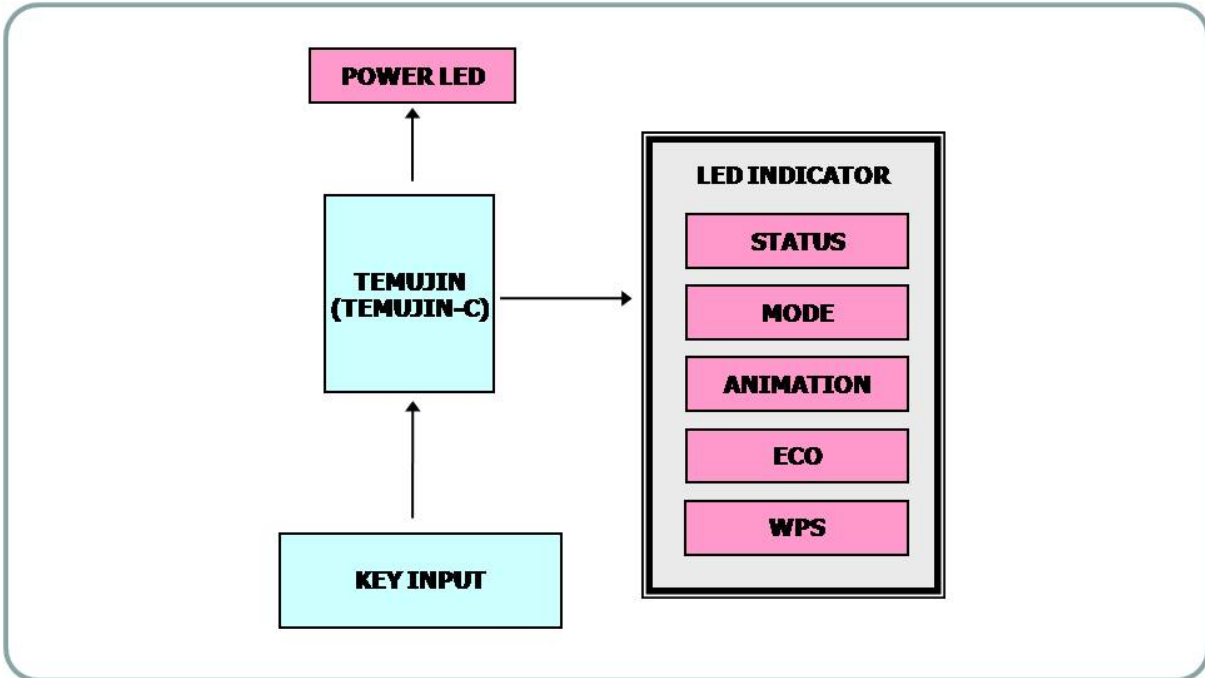

[OPE board image]



- **Information**
 - Part Code : JC92-02392A / JC92-02392B (Wireless model)
 - PBA name : OPE
- **Connection**

1	Direct sholder flat cable
---	---------------------------

2.2.5.3. Wireless LAN board (ML-216xW only)

The Wireless LAN Module supports 802.11b/g/n. It communicates with main board via SPI.

[WLAN board image]



- Information
 - Part Code : JC92-02402A
 - PBA name : PBA-WNPC
- Connection

1	INTERFACE CONNECTOR TO SYSTEM BOARD (JC39-01562A , FFC CABLE-WLAN)
---	---

2.2.5.4. SMPS/HVPS board

ML-216x series has a power board of integrated SMPS and HVPS.

The SMPS (Switching Mode Power Supply) Board supplies electric power to the Main Board and other boards through a Main Controller. The voltage provided includes +24V from a 110V/220V power input.

The HVPS board generates high-voltage channels which includes MHV, DEV DC, DEV AC, SUPPLY, THV.

[SMPS/HVPS board image]

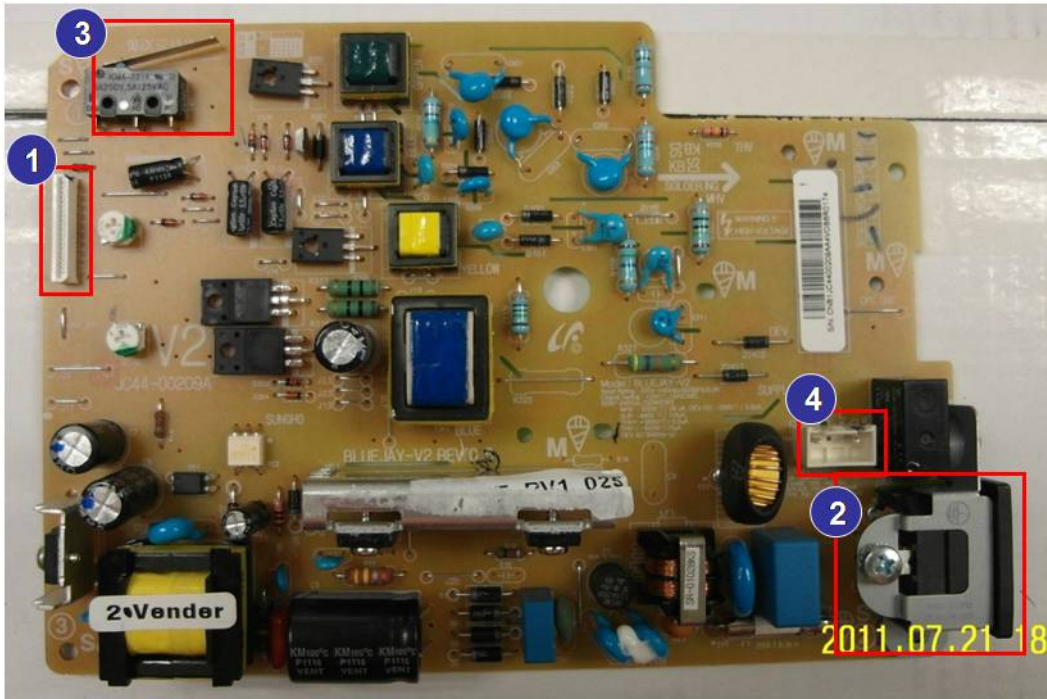

- **Specification**

- General Input / Output Voltage
- AC 110V (110V ~ 127V)
- AC 220V (220V ~ 240V)
- Input Current : 8.0A (110V) / 6.3A (220V)
- Output Power: 43.2W
 - DC 24V : 43.2W

- **Information**

	110V	220V
Part Code	JC44-00208A	JC44-00209A
PBA name	SMPS/HVPS V1	SMPS/HVPS V2

- **Connection**

1	Main Board interface connector
2	AC_Inlet
3	COVER OPEN/CLOSE Switch
4	FUSER_AC Output

• **Input / Output connector**

AC Output Connector(CN1)		
Pin Assign	Pin No.	Description
1	AC_L	AC Output for Heater Controller
2	AC_N	

DC Output Connector (CN2)		
PIN NO	PIN ASSIGN	Description
1	THV_READ	HVPS
2	PWM_MHV	HVPS
3	nTHV_EN	HVPS
4	PWM_DEV_DC	HVPS
5	+3.3V OPEN	COVER ON, OFF DETECT
6	PWM_DEV_AC	HVPS
7	+3.3V	COVER ON, OFF DETECT
8	nDEV_EN	HVPS
9	PWM_THV	HVPS
10	VPP_DEV_AC	HVPS
11	GND	Common Ground
12	+24VS1	Relay, Fuser
13	GND	Common Ground
14	GND	Common Ground
15	+24V	SMPS
16	RELAY_ON	AC RELAY ON (ACTIVE HIGH)
17	+24V	SMPS
18	GND	Common Ground
19	+24V	SMPS
20	FUSER_ON	FUSER_ON (ACTIVE HIGH)

2.2.5.5. Electrical Parts Location

1) Sensors

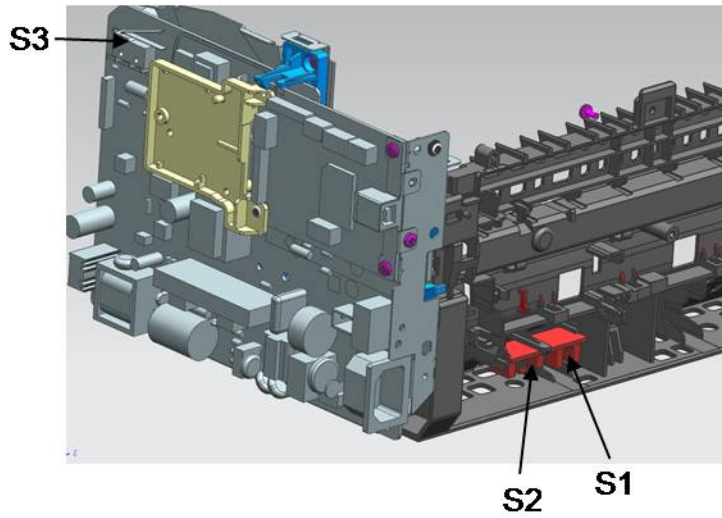

No.	Description	Controller	Function
S1	Photo interrupter (Feed Sensor)	PBA sensor	Paper detection
S2	Photo interrupter (width Sensor)	PBA sensor	Paper detection
S3	Switch Front Cover	SMPS	Cover Open detection

Motor, Clutch

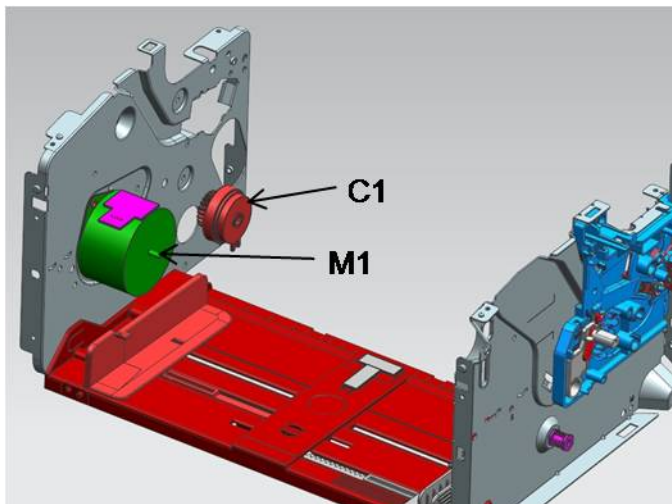

No.	Description
M1	Main motor
C1	Pick-Up clutch

2.2.6. Engine F/W Contol Algorithm

2.2.6.1. Feeding

If feeding from a tray, the drive of the pickup roller is controlled by controlling the clutch. The on/off of the clutch is controlled by controlling the general output port or the external output port. While paper moves, occurrence of Jam is judged as below.

Item	Description
JAM 0 or Paper Empty	<ul style="list-style-type: none">• After picking up, paper does not reach the Feed Sensor within a predetermined time.• After picking up, if the feed sensor is not on, re-pick up will be initiated. After re-picking up, if the feed sensor is not on after certain time, it is JAM 0• Even though the paper reaches to the feed sensor, the feed sensor does not detect the lead edge of the paper.
JAM 1	<ul style="list-style-type: none">• After the leading edge of the paper passes the feed sensor, the trailing edge of the paper does not clear the sensor the feed sensor after predetermined period of time.

2.2.6.2. Transfer

The charging voltage, developing voltage and the transfer voltage are controlled by PWM (Pulse Width Modulation). The each output voltage is changeable due to the PWM duty. The transfer voltage admitted when the paper passes the transfer roller is decided by environment conditions. The resistance value of the transfer roller is changed due to the surrounding environment or the environment of the set, and the voltage value, which changes due to the environment, is changed through the AD converter. The voltage value for impressing to the transfer roller is decided by the changed value.

2.2.6.3. Fusing

The temperature change of the heat roller's surface is changed to the resistance value through the use of a thermistor. The Main Board uses the resistance value of the Thermistor and converts it to a voltage value through the use of an AD converter, the temperature is decided based on the voltage value read. The AC power is controlled by comparing the target temperature to the value from the thermistor. If the value from the thermistor is out of controlling range while controlling the fusing, the error stated in the below table occurs.

- **Open Heat Error**

When the engine operates the warm-up process, if the temperature of the fixing unit is not higher than a specified temperature within a predetermined time, the engine defines Open Heat Error. When this error is detected, the engine stops all functions and keeps the error state. Also, the engine informs the error status of the main system, so it can take appropriate action; and then the error message is displayed at LCD window or LED informing the error status of the user.

- **Low Heat Error**

When the engine is at stand-by, printing or warm-up mode, if the temperature of the fixing unit is lower than the specified temperature at each state and the lower temperature state is maintained during the specified time, the engine defines Low Heat Error. When this error is detected, the engine stops all functions and keeps it at the error state. Also, the engine informs the error status of the main system, so it can take appropriate action; and then the error message is displayed at LCD window or LED informing the error status of the user.

- **Over Heat Error**

For overall engine state, if the temperature of the fixing unit is higher than the specified temperature and the temperature state is detected for a specific duration, then the engine defines Over Heat Error. When this error is detected, the engine stops all functions and keeps it at the error state. Also, the engine informs the error status of the main system, so it can take appropriate action; and then the error message is displayed at LCD window or LED informing the error status of the user.

2.2.6.4. LSU

LSU receives the image data from PVC or HPVC and make the latent image on OPC surface. It uses the single beam, LD. The errors related to LSU are as follows:

- **By Lready**

When the printing is started, the engine drives the polygon motor of LSU. After the specified time is elapsed, if the motor is not in a ready status, the engine detects the error that the polygon motor is not in a ready status. If this error happens, the engine stops all functions and keeps it at the error state. Also, the engine informs the error status of the main system and the error message is displayed at LCD window or LED informing the error status of the user.

- **By Hsync**

When the polygon motor is ready, the LSU sends out the signal called Hsync and used to synchronize with each image line. So, if the engine does not detect consecutively the signal for a fixed time, it defines the Hsync Error. If this error happens, the engine stops all functions and keeps it at the error state. Also, the engine informs the error status of the main system and then the error message is displayed at LCD window or LED informing the error status of the user. LSU Error Recovery: If the LReady or Hsync error happens, the paper is exited before the error code is initiated. The engine mode is changed to recovery mode and the engine informs the main system of the engine mode. The engine rechecks the LSU error, if the error does not reoccur printing is resumed.

2.2.7. Software Descriptions

2.2.7.1. Software system overview

The software system of this model is constructed with

- Host Software part that the application software operated in Window and Web Environment
- Firmware parts that is a Embedded software controls printing job.

2.2.7.2. Architecture

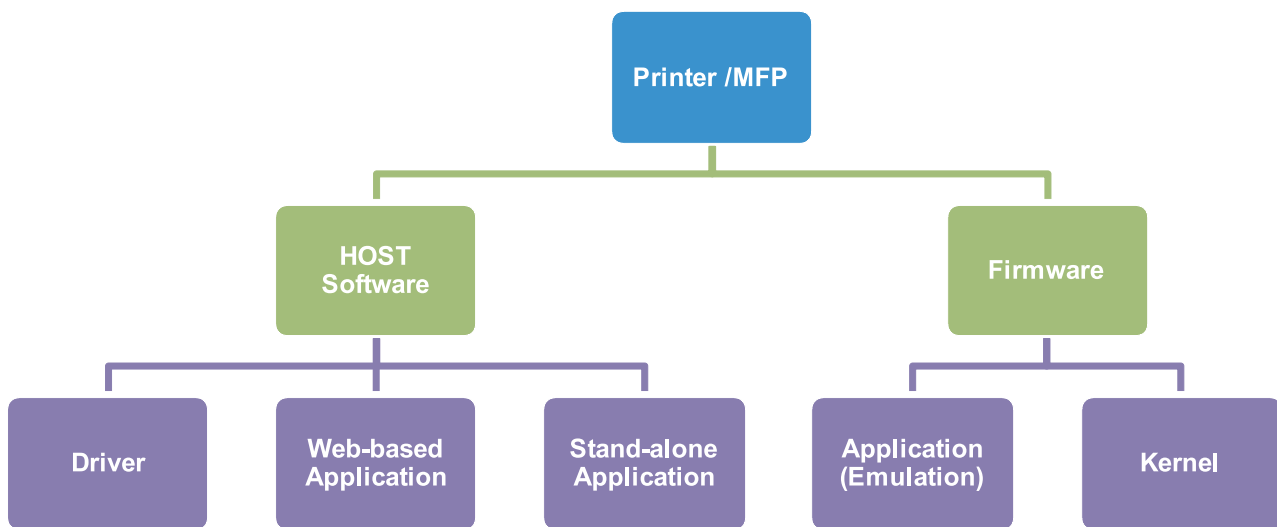

Host Software is made up of

- 1) Graphic User Interface offers the various editing functions to user in Host.
- 2) Driver translates the received document to a Printing Command language which printer can understand and transfers data to spooler.
- 3) Stand-alone Application offers the various printing application such as Easy Printer Manager, Printer Status in Window system.
- 4) Web-based-Application offers the same functions as Stand-alone Application in Web environment.

Firmware is made up of

- 1) Application (Emulation) that is a interpreter translates data received from Host to a printing language (PCL, PS, GDI, etc.) to be able to make the user to take same output as originally one what composed in Host.
- 2) Kernel controls and manage the whole procedure including Control flow and Printing Job before transferring to Engine system.

2.2.7.3. Data and Control Flow

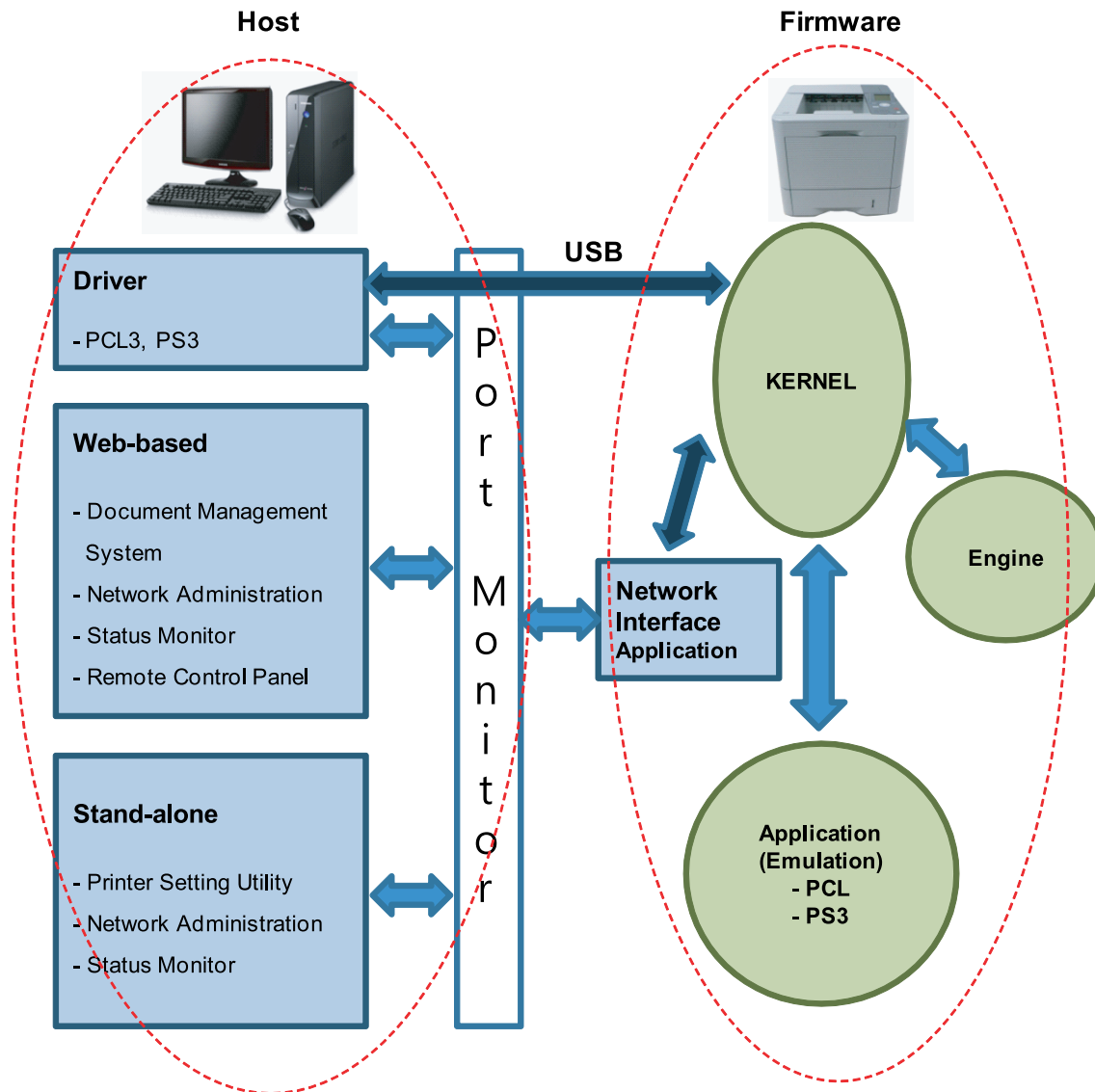

The above Block Diagram is explained that:

Host Side is made up of

- 1) Driver that is Windows application software translate printed data to one of printer language and create spooler file.
- 2) Web-based Application that offer a various printer additional functions, management of printing job, printer administration, Status monitor to monitoring the printer status by real time in Web, independent environment on OS.
- 3) Stand-alone Application that is a similar Window software as same as above 2.
- 4) Port Monitor that manages the network communication between spooler and Network Interface Card, or various additional application and Network Interface Card,(this is, at first, make communication logical port, manage the data, transfer them from spooler to network port, and offer the result of printing).

Firmware Side is made up of

- 1) Network Interface Card is that relay the communication between Host and kernel using various network protocol.
- 2) Kernel is that manages the flow control of emulation procedure, receiving data from Host or Network card and printing with engine & rendering job.

- 3) Emulation is that interprets the various output data from selected emulation.
- 4) Engine is that prints rendered bit-map data to paper with required size and type by Kernel.

And then, for Job Spooling function for Multi-User, Multi-Printing that is occurred in Network printing and various additional printing functions, this Kernel use max. 10 Queuing systems in a memory.

In Printing, the two procedures are

1) Case of using USB Port

- After user start to print the wanted document to PCL string or compressed GDI bit-map data, the Driver translates the all graphic data of the client PC and send data to host spooler. And then the spooler sends the data stream to the printer via USB port.
- Kernel receives this data from Host, and then select emulation fit to data and start selected one. After emulation job end, Kernel sends the output bit-map data to Engine using Printer Video Controller (by clock type for LSU).
- Engine print the received data to required paper with the sequential developing process.

2) Case of using Network Interface Card

- After user start to print the wanted document to PCL string or compressed GDI bit-map data, Driver translate the all graphic data of it and send data to host spooler.
- If so, Port monitor managing network port receives data from spooler and sends a data stream to the Network Interface Card.
- Network interface card receives it and send to Kernel part.
- Kernel receives this data from Host, and then select emulation fit to data and start selected one. After emulation job end, Kernel sends the output bit-map data to Engine using Printer Video Controller (by clock type for LSU).
- Engine print the received data to required paper with the sequential developing process.

3. Disassembly and Reassembly

3.1. Precautions when replacing parts

3.1.1. Precautions when assembling and disassembling

- Use only approved Samsung spare parts. Ensure that part number, product name, any voltage, current or temperature rating are correct. Failure to do so could result in damage to the machine, circuit overload, fire or electric shock.
- Do not make any unauthorized changes or additions to the printer, these could cause the printer to malfunction and create electric shock or fire hazards.
- Take care when dismantling the unit to note where each screw goes. There are 19 different screws. Use of the wrong screw could lead to system failure, short circuit or electric shock.
- Do not disassemble the LSU unit. Once it is disassembled dust is admitted to the mirror chamber and will seriously degrade print quality. There are no serviceable parts inside.
- Regularly check the condition of the power cord, plug and socket. Bad contacts could lead to overheating and fire. Damaged cables could lead to electric shock or unit malfunction.

3.1.2. Precautions when handling PBA

Static electricity can damage a PBA, always use approved anti-static precautions when handling or storing a PBA.

- **Precautions when moving and storing PBA**
 - 1) Please keep PBA in a conductive case, anti-static bag, or wrapped in aluminum foil.
 - 2) Do not store a PBA where it is exposed to direct sunlight.
- **Precautions when replacing PBA**
 - 1) Disconnect power connectors first, before disconnecting other cables.
 - 2) Do not touch any soldered connections, connector terminals or other electronic parts when handling insulated parts.
- **Precautions when checking PBA**
 - 1) Before touching a PBA, please touch other grounded areas of the chassis to discharge any static electrical charge on the body.
 - 2) Take care not to touch the PBA with your bare hands or metal objects as you could create a short circuit or get an electric shock. Take extra care when handling PBAs with moving parts fitted such as sensors, motors or lamps as they may get hot.
 - 3) Take care when fitting, or removing, screws. Look out for hidden screws. Always ensure that the correct screw is used and always ensure that when toothed washers are removed they are refitted in their original positions.

3.1.3. Releasing Plastic Latches

Many of the parts are held in place with plastic latches. The latches break easily; release them carefully.

To remove such parts, press the hook end of the latch away from the part to which it is latched.

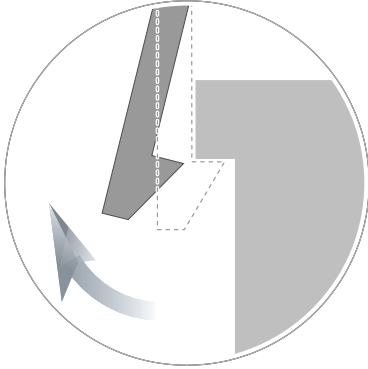

3.2. Screws used in the printer

The screws listed in the table below are used in this printer. Please ensure that, when you disassemble the printer, you keep a note of which screw is used for which part and that, when reassembling the printer, the correct screws are used in the appropriate places.

Part Code	Location	Description	Qty
6003-000196	FRAME	SCREW-TAPTTYPE;PWH,+ ,B,M3,L10,NI PLT,SWRCH18A	18
6003-000269	FRAME	SCREW-TAPTTYPE;BH,+ ,-,S,M3,L6,ZPC(WHT),SWRCH18A,-	13
6006-001078	FUSER	SCREW-TAPTTYPE;PH,+ ,WSP,B,M3,L10,ZPC(WHT),SWRCH18A	1
6003-000269	FUSER-LOWER	SCREW-TAPTTYPE;BH,+ ,-,S,M3,L6,ZPC(WHT),SWRCH18A,-	2
6003-000196	FUSER-UPPER	SCREW-TAPTTYPE;PWH,+ ,B,M3,L10,NI PLT,SWRCH18A	1
6003-000282	FUSER-UPPER	SCREW-TAPTTYPE;BH,+ ,-,B,M3,L8,ZPC(BLK),SWRCH18A,-	7
6003-000196	FRAME-PATH	SCREW-TAPTTYPE;PWH,+ ,B,M3,L10,NI PLT,SWRCH18A	3
6003-000269	FRAME MAIN-LEFT	SCREW-TAPTTYPE;BH,+ ,-,S,M3,L6,ZPC(WHT),SWRCH18A,-	6
6003-000282	FRAME MAIN-LEFT	SCREW-TAPTTYPE;BH,+ ,-,B,M3,L8,ZPC(BLK),SWRCH18A,-	2
6002-000308	FRAME MAIN-RIGHT	SCREW-TAPTTYPE;PH,+ ,-,B,M2.6,L6,ZPC(WHT),SWRCH18A,-	4
6003-000269	FRAME MAIN-RIGHT	SCREW-TAPTTYPE;BH,+ ,-,S,M3,L6,ZPC(WHT),SWRCH18A,-	2
6003-000269	FRAME MAIN-MIDDLE	SCREW-TAPTTYPE;BH,+ ,-,S,M3,L6,ZPC(WHT),SWRCH18A,-	5
6003-000282	LSU	SCREW-TAPTTYPE;BH,+ ,-,B,M3,L8,ZPC(BLK),SWRCH18A,-	5
6003-000269	FRAME-FEED IDLE	SCREW-TAPTTYPE;BH,+ ,-,S,M3,L6,ZPC(WHT),SWRCH18A,-	2
6003-000282	COVER-TOP	SCREW-TAPTTYPE;BH,+ ,-,B,M3,L8,ZPC(BLK),SWRCH18A,-	2
6003-000196	MAINLINE	SCREW-TAPTTYPE;PWH,+ ,B,M3,L10,NI PLT,SWRCH18A	4
6003-000269	MAINLINE	SCREW-TAPTTYPE;BH,+ ,-,S,M3,L6,ZPC(WHT),SWRCH18A,-	5

3.3. Replacing the Main SVC parts

3.3.1. Cover

1. Open the top cover. Remove the right cover from the rear and bottom hooks.



2. Remove the left cover from the rear and bottom hooks.



3. Remove the rear cover after removing 3 screws.

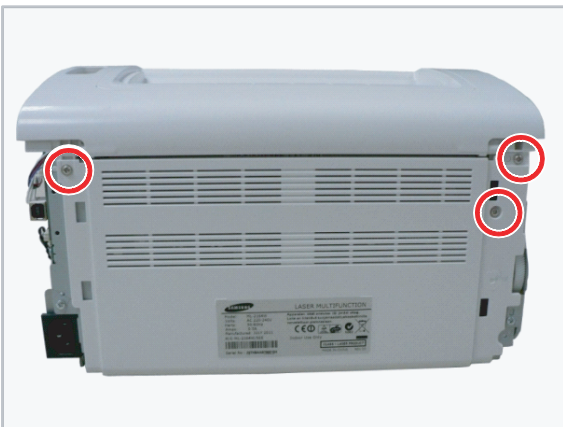

4. Open the COVER-OPEN. Release both jam lever from it.

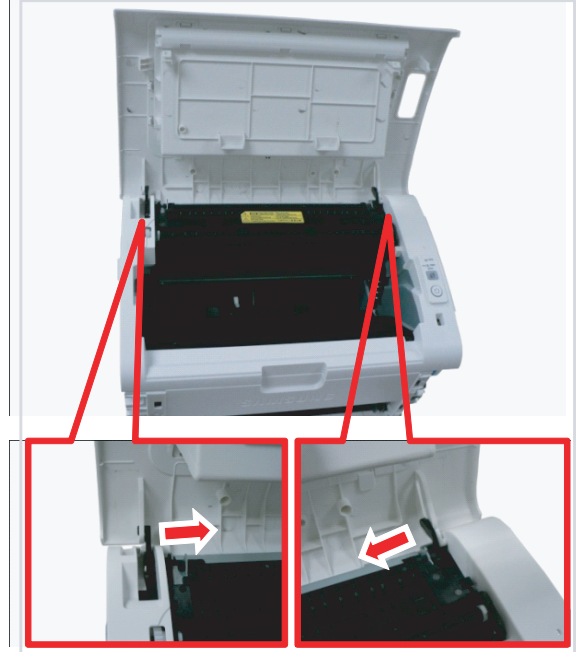

5. Remove the COVER-OPEN after releasing it from the COVER-TOP.

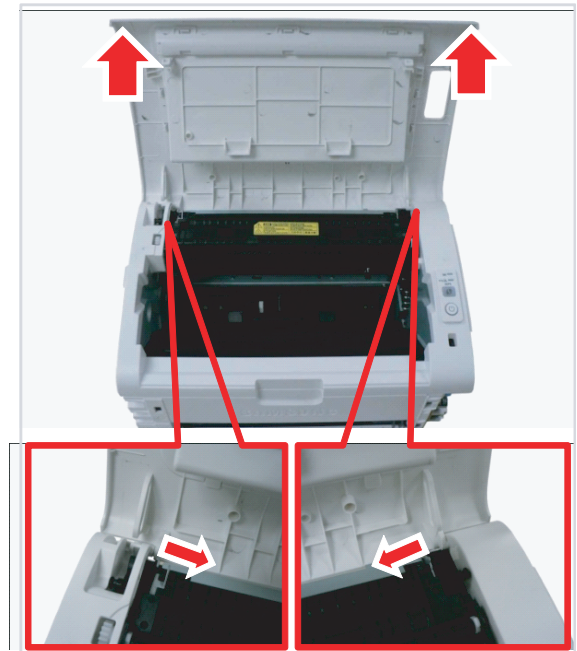

6. Unplug the OPE connector from the main board.

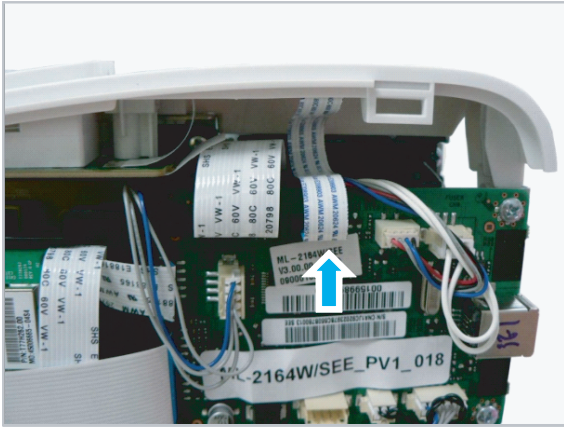

8. Remove the front cover after remove 2 screws.

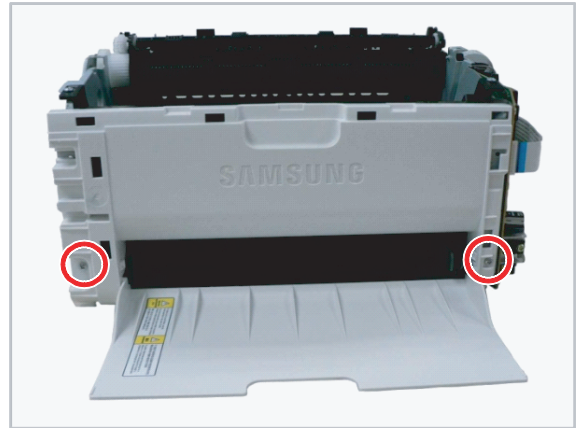

7. Remove the COVER-TOP.

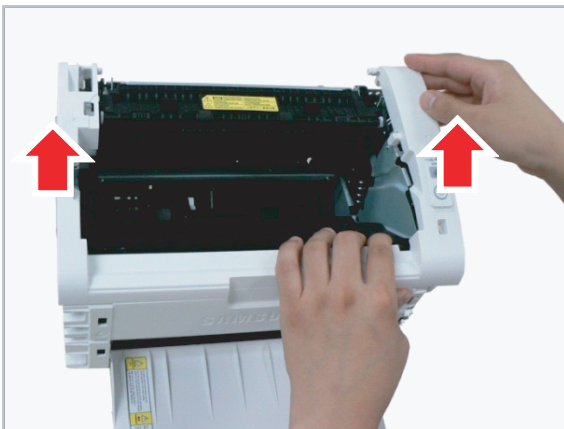

3.3.2. Main board

1. Remove 1 screw. (In case of wireless model, remove the WLAN board.)

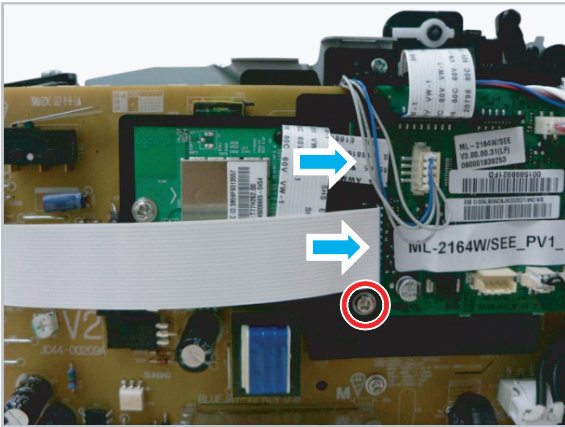

2. Unplug all connectors. Remove 2 screws. And then remove the main board.

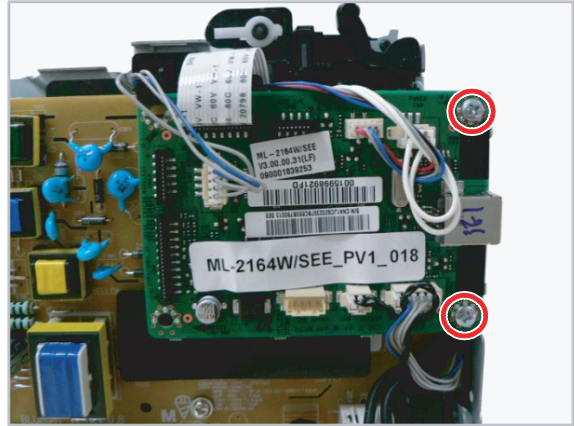

3.3.3. Fuser Unit

1. Remove the main board. (Refer to 3.3.2)
2. Unplug the fuser connector.

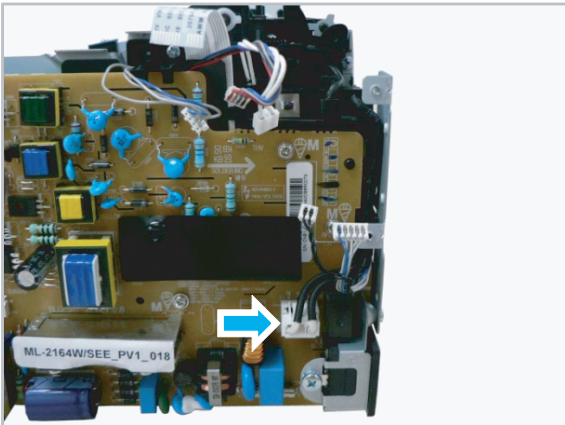

3. Release the fuser unit after removing 3 screws.

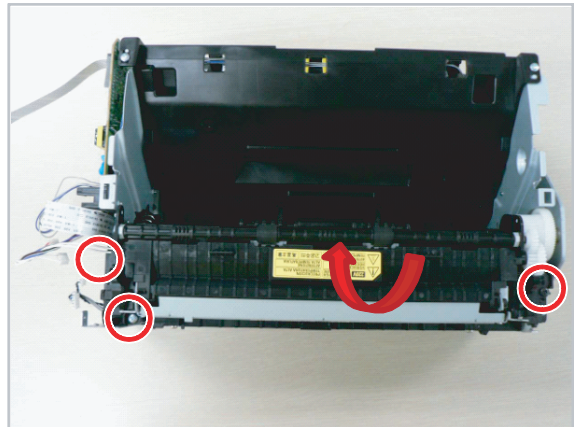

3.3.4. SMPS/HVPS board

1. Remove the main board. (Refer to 3.3.2)
2. Unplug the fuser connector. Remove 8 screws. And release the SMPS/HVPS board.

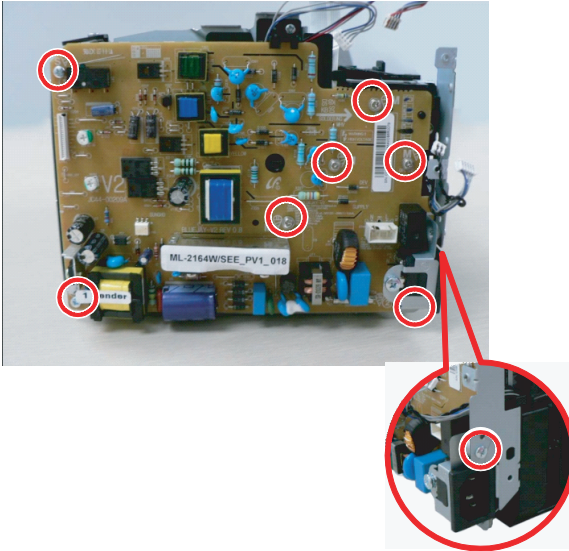

3.3.5. Drive Unit

1. Release the Drive Unit after removing 4 screws.

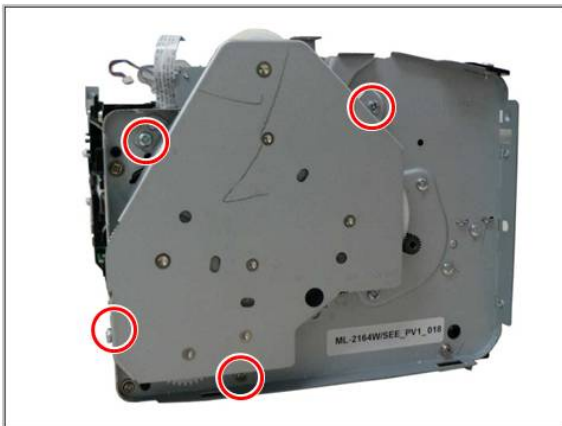

3.3.6. LSU

1. Remove all covers. (Refer to 3.3.1)
2. Remove 2 screws securing the LSU cover.

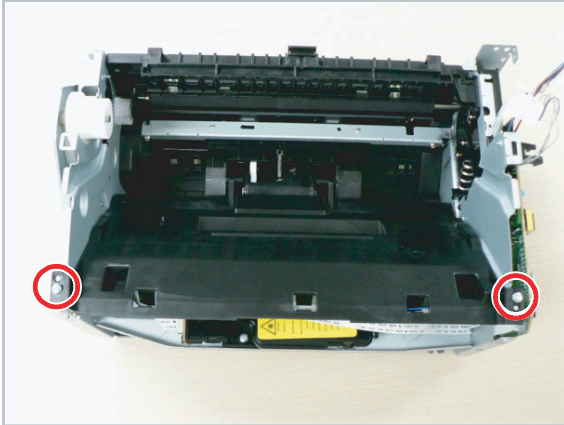

4. Unplug 2 flat cables. Remove 3 screws. And release the LSU.



3. Remove 2 screws securing the LSU cover. Unplug the motor connector. And release the LSU cover.

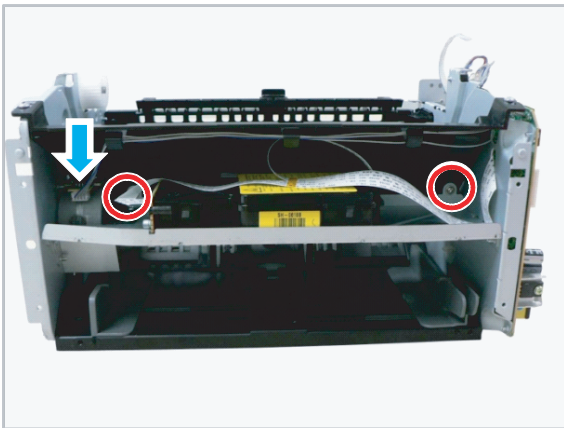

3.3.7. Feed Sensor PBA

1. Remove the rear cover. (Refer to 3.3.1)
2. Unplug the connector after releasing the Feed Sensor PBA.

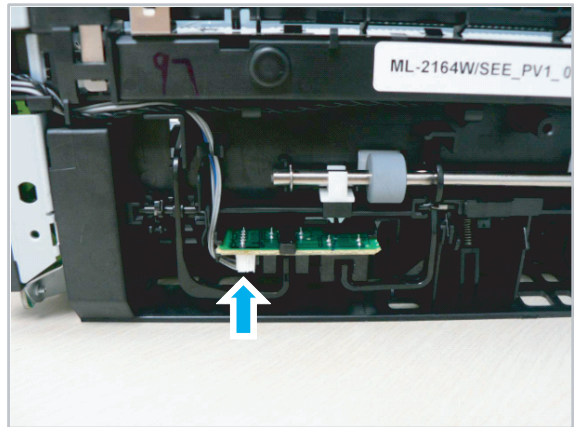

3.3.8. Pick up roller

1. Remove 2 screws from the bottom.
2. Release the pick up roller.

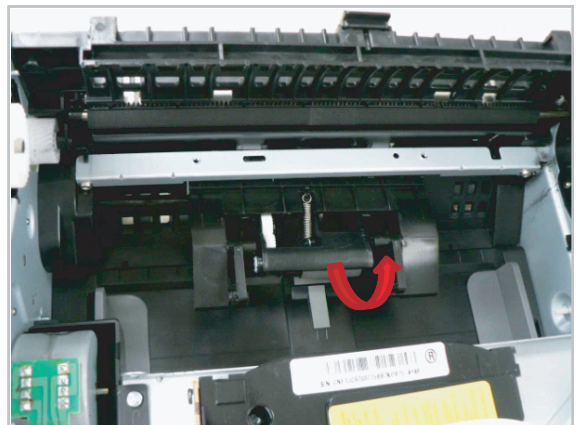
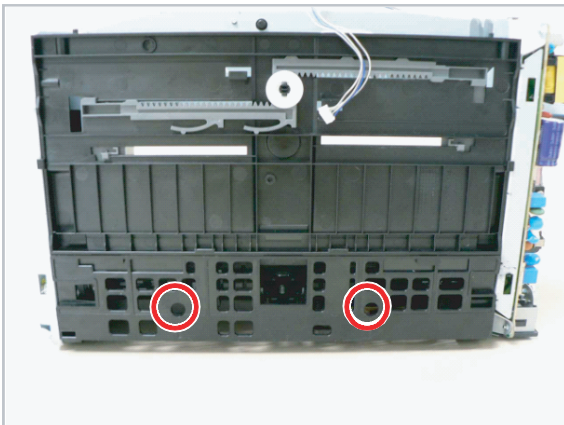

3.3.9. Motor

1. Release the left frame after removing 6 screws.

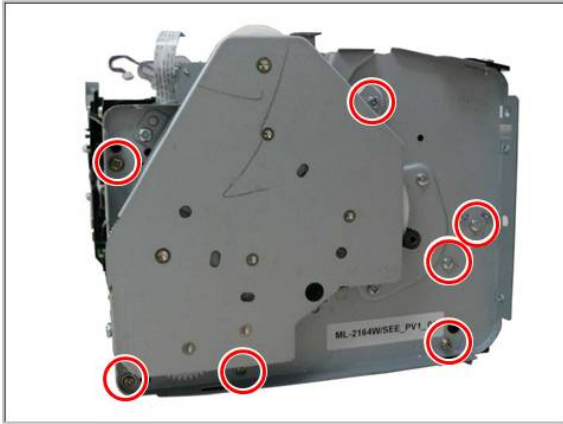

2. Release the motor after removing 2 screws.

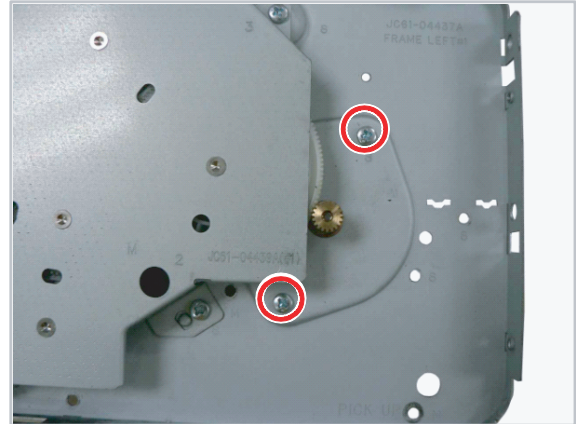

3.3.10. Transfer roller

1. Open the top cover. Remove the toner cartridge.



2. Remove the right cover from the rear and bottom hooks.



3. Remove the left cover from the rear and bottom hooks.



4. Remove the rear cover after removing 3 screws.

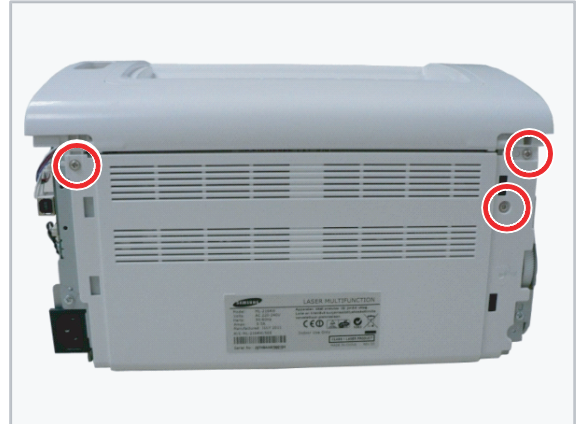

5. Push the Bush-TR from the rear and remove the Transfer roller from the front.

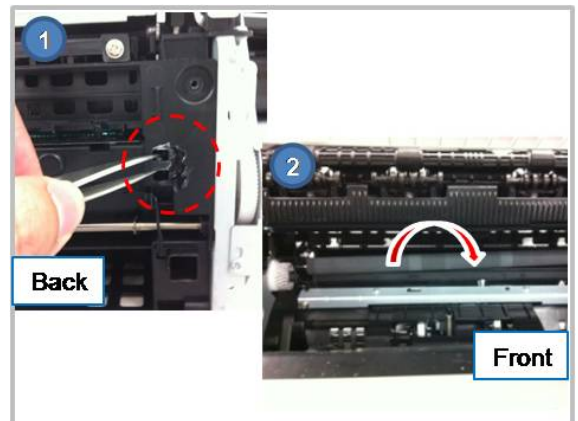

6. When reassembling it, push the bush-TR in two direction like below picture.

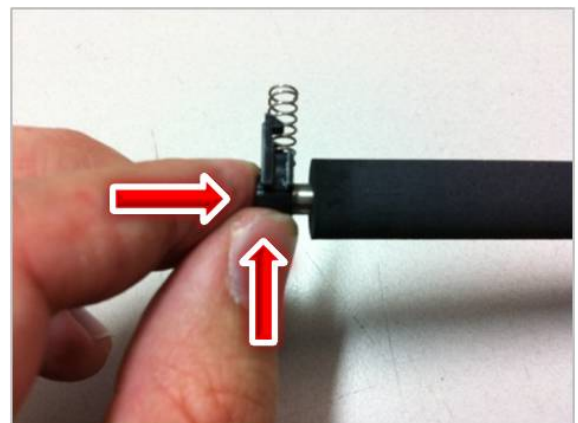

4. Alignment and Troubleshooting

4.1. Alignment and Adjustments

This chapter describes the main functions for service, such as the product maintenance method, the test output related to maintenance and repair, Jam removing method, and so on. It includes the contents of manual.

4.1.1. Control Panel



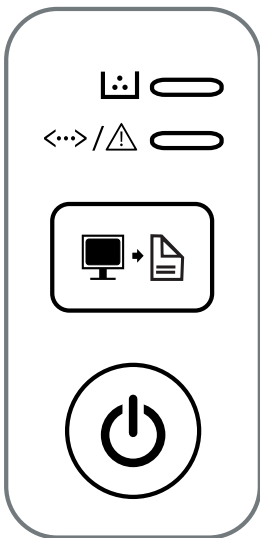

NOTE

This control panel may differ from your machine depending on its model. There are various types of control panels.



1		Toner LED	Shows the status of the toner.
2		Status LED	Shows the status of your machine.
3		WPS	Configures the wireless network connection easily without a computer.



4		Print Screen	<ul style="list-style-type: none"> • Prints the screen <ul style="list-style-type: none"> • Press this button and the green LED will start blinking. If you want to print only the active screen, release the button when the green LED stops blinking. If you want to print the whole screen, release the button while it's blinking. <div style="background-color: #e0e0e0; padding: 5px; margin: 10px 0;"> <p> NOTE</p> <ul style="list-style-type: none"> ▪ Print Screen can only be used in the Windows and Macintosh operating systems. ▪ You can only use this function with USB-connected machine. ▪ When printing the active window/whole monitor screen using the print screen button, the machine may use more toner depending on what is being printed. ▪ You can only use this function if the machine's Easy Printer Manager program is installed. </div> <ul style="list-style-type: none"> • Prints configuration sheet and Network configuration sheet <ul style="list-style-type: none"> • Press and hold this button for about 10 seconds until the green LED blinks slowly, and release. • Prints event log report & supplies info report & usage counter <ul style="list-style-type: none"> • Press and hold this button for about 10 seconds until the green LED is on (not blinking), and release. • Manual print <ul style="list-style-type: none"> • Press this button each time you load a sheet of paper in the tray if you have selected Manual Feeder for Source in your printer driver.
5		Power	You can turn the power off or wake the machine up from the sleep mode with this button.

4.1.2. Understanding the status LED

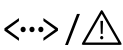
Status LED

Status		Description	
	Off	The machine is off-line.	
	Green	Blinking	<ul style="list-style-type: none"> When the backlight slowly blinks, the machine is receiving data from the computer. When the backlight blinks rapidly, the machine is printing data.
		On	The machine is on-line and can be used.
	Red	Blinking	A minor error has occurred and the machine is waiting for the error to be cleared. When the problem is cleared, the machine resumes.
		On	<ul style="list-style-type: none"> The cover is opened. Close the cover. There is no paper in the tray. Load paper in the tray. The machine has stopped due to a major error.
	Orange	Blinking	Upgrading firmware.
		On	A paper jam has occurred.

Toner LED / WPS LED

Status		Description	
 (Toner LED)	Orange	Blinking	Small amount of toner is left in the cartridge. The estimated cartridge life of toner is close. Prepare a new cartridge for replacement. You may temporarily increase the printing quality by redistributing the toner.
		On	A toner cartridge has almost reached its estimated cartridge life*. It is recommended to replace the toner cartridge.
		Off	All toner cartridges are at normal capacity.
 (WPS LED)**	Blue	Blinking	The machine is connecting to a wireless network.
		On	The machine is connected to a wireless network.
		Off	The machine is disconnected from a wireless network.
 (Power LED)	Blue	On	The machine is in power save mode.
		Off	The machine is in ready mode or the machine's power is off.

* Estimated cartridge life means the expected or estimated toner cartridge life, which indicates the average capacity of print-outs and is designed pursuant to ISO/ IEC 19752. The number of pages may be affected by operating environment, printing interval, graphics, media type and media size. Some amount of toner may remain in the cartridge even when red LED is on and the printer stops printing.

** Wireless model only

4.1.3. Jam Removal

NOTE

To avoid tearing the paper, pull the jammed paper out slowly and gently.

In tray

- 1) Remove the original jammed paper by gently pulling it straight out.

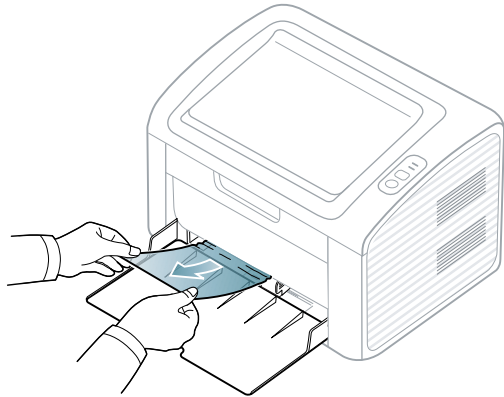

Inside the machine

NOTE

The fuser unit area is hot. Take care when removing paper from the machine.

- 1) Before opening the top cover, close the output support first.
- 2) Open the top cover. And then remove the toner cartridge.

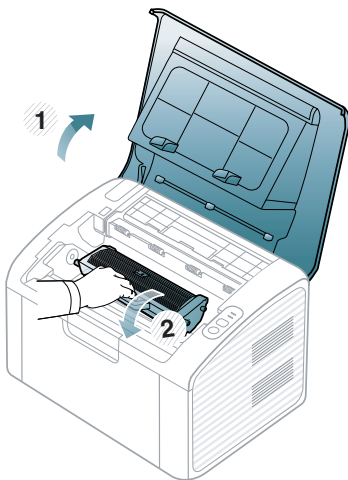

- 3) Open the fuser unit cover.

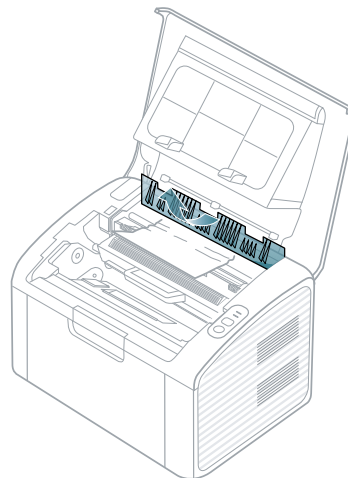

4. Alignment and Troubleshooting

- 4) Remove the original jammed paper by gently pulling it straight out.

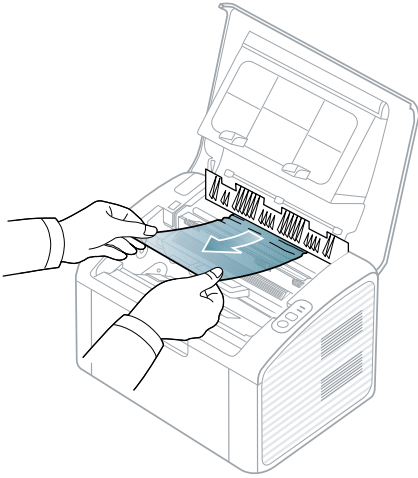

- 5) Re-install the toner cartridge. Close the fuser unit cover.

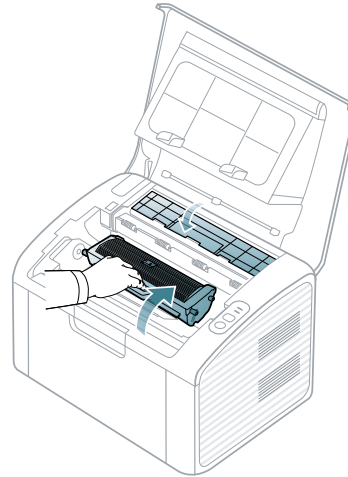

- 6) Close the top cover and open the output tray.

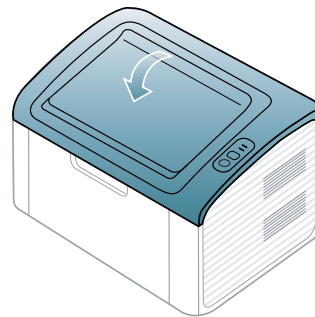

4.1.4. Periodic Defective Image

If an image defects appears at regular intervals on the printed-paper, it is due to a faulty or damaged roller. Refer to the table below and check the condition of the appropriate roller.

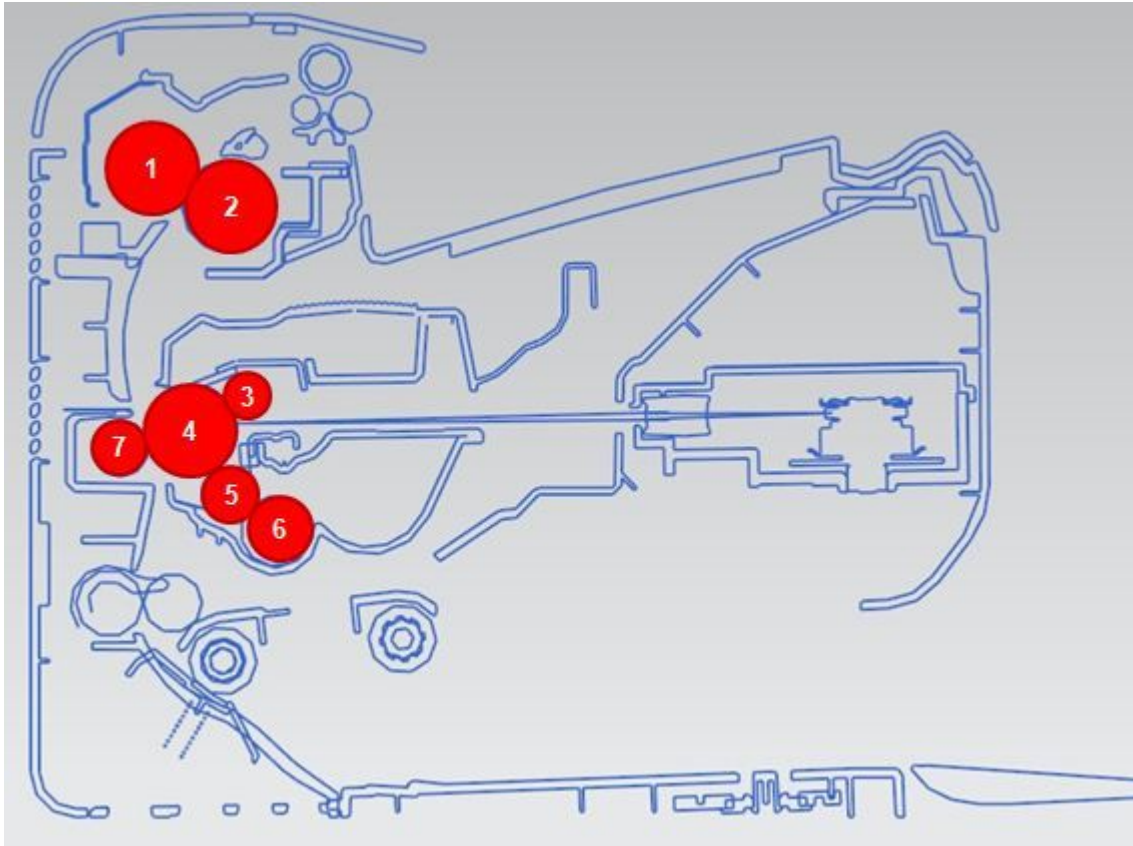

	Roller	Period (mm)	Phenomenon	Defective part
1	Pressure Roller	62.8 mm	Background	Fuser Unit
2	Heat Roller	63.7 mm	Black spot and image ghost	
3	Charging Roller	26.7 mm	Black Spot and line and periodic band	Toner Cartridge
4	OPC Drum	62.9 mm	White and Black Spots	
5	Developing Roller	33.7 mm	White spot, Horizontal black band	
6	Supply Roller	78.2 mm	Periodic Band by little difference of density	
7	Transfer Roller	39.3 mm	Ghost, Damaged image by abnormal transfer	Transfer roller

4.1.5. Useful management tools

4.1.5.1. Using Samsung Easy Printer Manager (Windows and Macintosh only)

NOTE

- This feature may not be available depending on model or optional goods.
- Available for Windows or Macintosh OS users only.
- For Windows, Internet Explorer 6.0 or higher is the minimum requirement for Samsung Easy Printer Manager.

Samsung Easy Printer Manager is an application that combines Samsung machine settings into one location. Samsung Easy Printer Manager combines device settings as well as printing environments, settings/actions and launching. All of these features provide a gateway to conveniently use your Samsung machine. Samsung Easy Printer Manager provides two different user interfaces for the user to choose from: the basic user interface and the advanced user interface. Switching between the two interfaces is easy: just click a button.

Understanding Samsung Easy Printer Manager

To open the program:

- For Windows, Select Start > Programs or All Programs > Samsung Printers > Samsung Easy Printer Manager > Samsung Easy Printer Manager.
- For Macintosh, Open the Applications folder > Samsung folder > Samsung Easy Printer Manager.

The Samsung Easy Printer Manager interface is comprised of various basic sections as described in the table that follows:

NOTE

The screenshot may differ depending on operating system you are using.

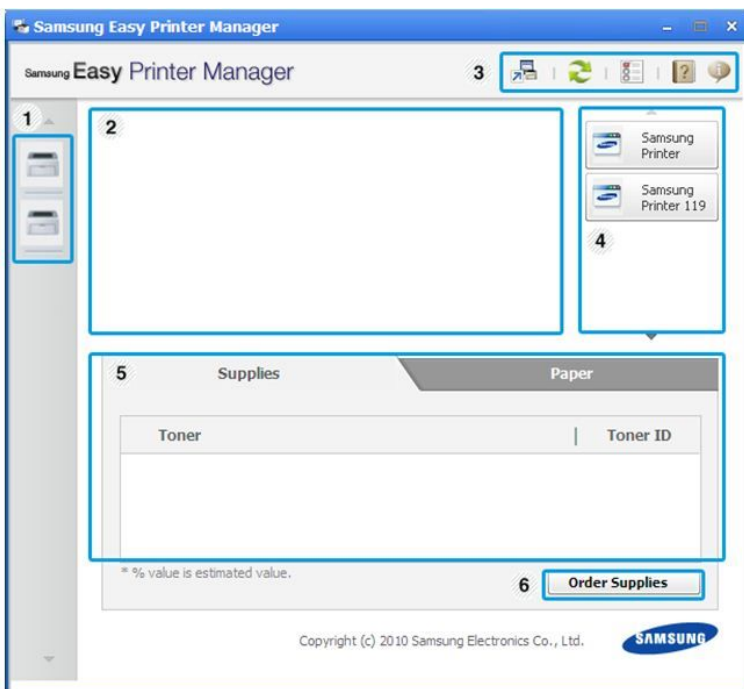

No	Area	Description
1	Printer List	The printer list displays the installed printer icons on your computer.
2	Printer Information	<p>This area gives you general information about your machine. You can check information, such as the machine's model name, IP address (or Port name), and machine status.</p> <div style="background-color: #e0e0e0; padding: 5px;">  NOTE Troubleshooting button: This button opens Troubleshooting Guide when an error occurs. You can directly open the necessary section in the user's guide. </div>
3	Application Information	Includes links for changing to the advanced settings, preference, help, and about.
4	Quick links	Displays Quick links to machine specific functions. This section also includes links to applications in the advanced settings.
5	Contents Area	Displays information about the selected machine, remaining toner level, and paper. The information will vary based on the machine selected. Some machines do not have this feature.
6	Order Supplies	Click on the Order button from the supply ordering window. You can order replacement toner cartridge(s) from online.

Advanced settings user interface overview

The advanced user interface is intended to be used by the person responsible for managing the network and machines.

- **Device Settings**

You can configure various machine settings such as machine setup, paper, layout, emulation, network, and print information.

- **Alert Settings**

This menu includes settings related to error alerting.

- **Printer Alert** : Provides settings related to when alerts will be received.
- **Email Alert** : Provides options relating to receiving alerts via email.
- **History Alert** : Provides a history of device and toner related alerts.

- **Job Accounting**

Provides querying of quota information of the specified job accounting user. This quota information can be created and applied to devices by job accounting software such as SyncThru™ or CounThru™ admin software.

4.1.5.2. Using Samsung Printer Status (Windows only)

The Samsung Printer Status is a program that monitors and informs you of the machine status.

NOTE



- The Samsung Printer Status window and its contents shown in this user’s guide may differ depending on the machine or operating system in use.
- Check the operating system(s) that are compatible with your machine.

Samsung Printer Status overview

If an error occurs while operating, you can check the error from the Samsung Printer Status. Samsung Printer Status is installed automatically when you install the machine software.

You can also launch Samsung Printer Status manually. Go to the **Printing Preferences** , click the **Basic** tab > **Printer Status** button.

These icons appear on the Windows task bar:

Icon	Mean	Description
	Normal	The machine is in ready mode and experiencing no errors or warnings.
	Warning	The machine is in a state where a soft error has occurred. For example, a toner low status, which may lead to toner empty status.
	Error	The machine has at least one hard error, such as out of paper, fuser error, etc. Machine does not have ability to come to ready without customer intervention.

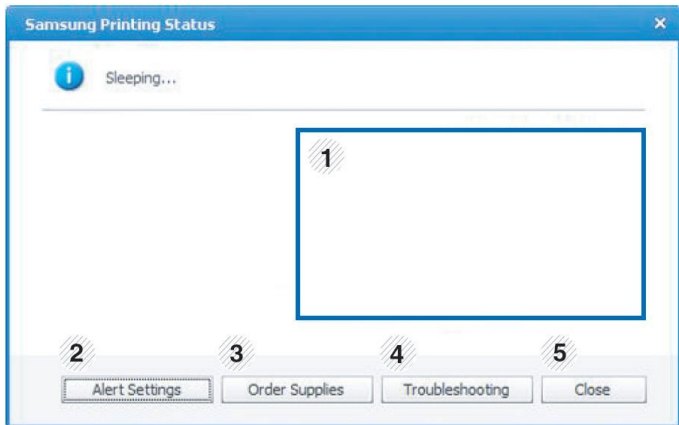

1	Toner Level	You can view the level of toner remaining in each toner cartridge. The machine and the number of toner cartridge(s) shown in the above window may differ depending on the machine in use. Some machines do not have this feature.
2	Alert Settings	Select the settings you want from the options window.
3	Order Supplies	You can order replacement toner cartridge(s) from online.
4	Troubleshooting	You can directly open the troubleshooting section in the user’s guide.
5	Close	Close the window.

4.1.5.3. Using Smart Panel (Linux only)

Smart Panel is a program that monitors and informs you of the machine's status, and allows you to customize the machine's settings. You can download Smart Panel from the Samsung website.

NOTE



- The Smart Panel window and its contents shown in this user's guide may differ depending on the machine or operating system in use.
- Check the operating system(s) that are compatible with this model.

Smart Panel overview

If an error occurs while operating, you can check the error from the Smart Panel. You can also launch Smart Panel manually.

Double-click the Smart Panel icon  in the Notification Area.



1	Toner Level	You can view the level of toner remaining in each toner cartridge. The machine and the number of toner cartridge(s) shown in the above window may differ depending on the machine in use. Some machines do not have this feature.
2	Buy Now	You can order replacement toner cartridge(s) from online.
3	User's Guide	You can view the online User's Guide.  NOTE This button opens the Troubleshooting Guide when an error occurs. You can directly open the troubleshooting section in the user's guide.
4	Printer Setting	You can configure various machine settings in the Printer Settings Utility window. Some machines do not have this feature  NOTE If you connect your machine to a network, the SyncThru™ Web Service window appears instead of the Printer Settings Utility.

Changing Smart Panel's settings

Right-click in Linux on the Smart Panel icon and select Configure smart panel. Select the settings you want from the Configure smart panel window.

4.1.5.4. Using SyncThru Web Service (SWS)

SWS is an embedded web server in the machine. This web server informs you of machine configuration, version, status and allows you to customize the machine’s settings. You can contact this server via wired and wireless network using your web browser in the remote place.

Connecting preparations

- Wired or Wireless Network connection is established.
- Browser (Ex> Internet Explorer) Program on your PC network connected

SWS overview

SyncThru Web Service (SWS)

- accepts HTTP request via port 80 as normal web servers.
- provides interface to users information of networked printers and allow to configure the setting of printers.
- is able to provide more complicated options than Local UI for printer configuration.

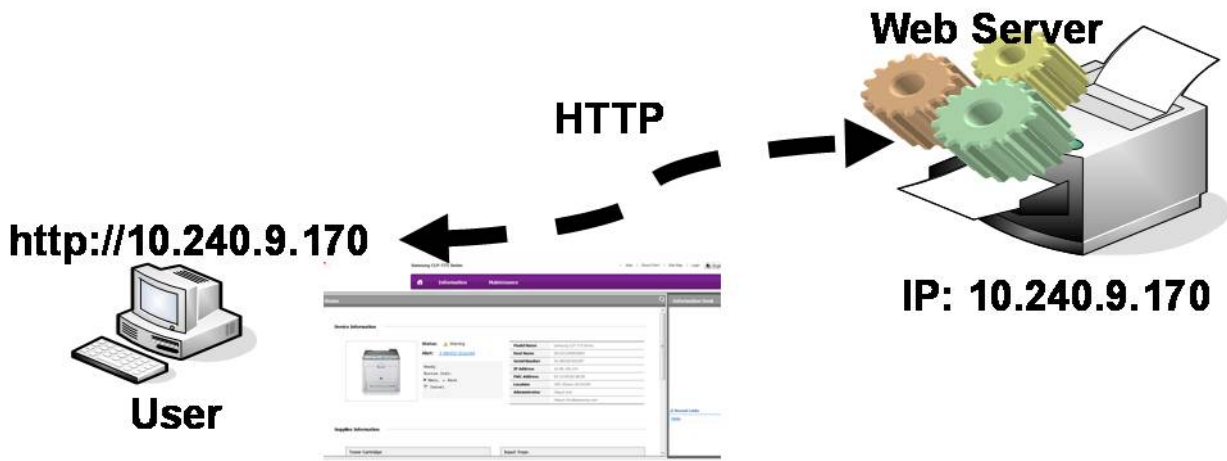

Connection Procedure

- 1) Open the Web-browser and input IP address of machine. Click “Login”.
- 2) Log-in Admin Mode. (ID: admin, PW: sec00000)
- 3) Select pages to check the configuration and customize the settings.

 **CAUTION**

Please, change SWS Default ID and Password for system security in case of your first connection.

 **NOTE**

If the machine supports 'Direct Print', you can enable this function using the SWS menu. The default configuration is 'Disabled' for your security.

Firstly, you have to login to SWS.

- 1) Click 'Direct Print Configuration' in the pop up windows when clicking 'Direct Print'.
- 2) In the 'Services' Menu, check 'Direct Print'.

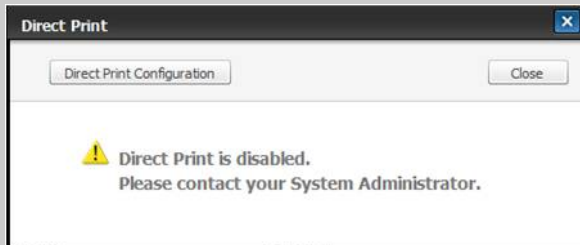

Or,

- 1) Click 'System Security' in the 'Security' menu.
- 2) Select 'Feature Management' in the left frame.
- 3) In the 'Services' Menu, check 'Direct Print'.

4.1.6. Updating Firmware

This chapter includes instructions for updating the printer firmware. You can update the printer firmware by using one of the following methods :

- Update the firmware by using the USB port.
- Update the firmware by using the Network.

4.1.6.1. Update the firmware by using the USB port

Upgrading preparations

- usblast2.exe : Tool which sends firmware data to printer.
- Firmware file to update.

Upgrade Procedure

- 1) Turn the machine off.
- 2) Connect USB cable to printer.
- 3) Turn the machine on. Check if the printer is the ready status.
- 4) Drag the firmware file and Drop down on the usblast2.exe.

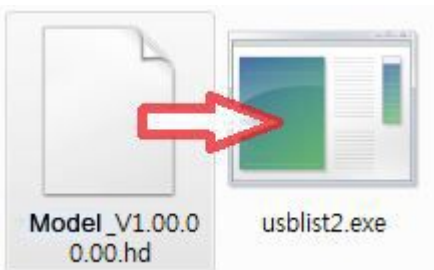

And then firmware update will be started automatically.

- 5) When upgrading is completed, machine is automatically re-booting.

4.1.6.2. Update the firmware by using the network (ML-216xW only)

Upgrading preparations

- Wired or Wireless Network connection is established.
- Firmware file to update

Upgrade Procedure

- 1) Open the Web-browser and input IP address of machine. Click “Login”.

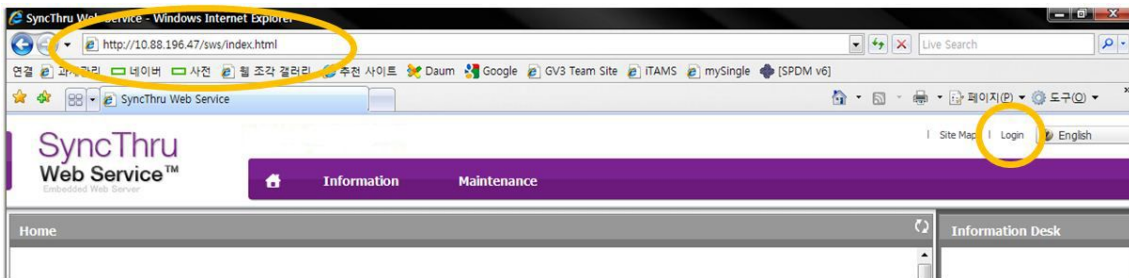

- 2) Log-in Admin Mode. (ID: admin, PW: sec00000)

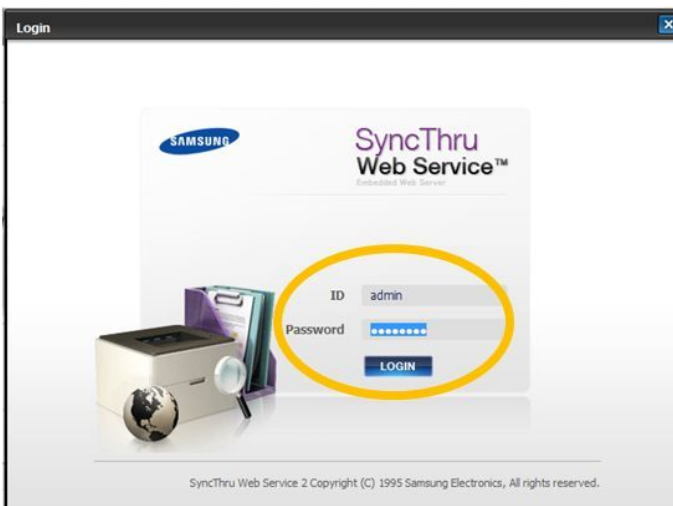

- 3) Select Maintenance menu and click “upgrade wizard”

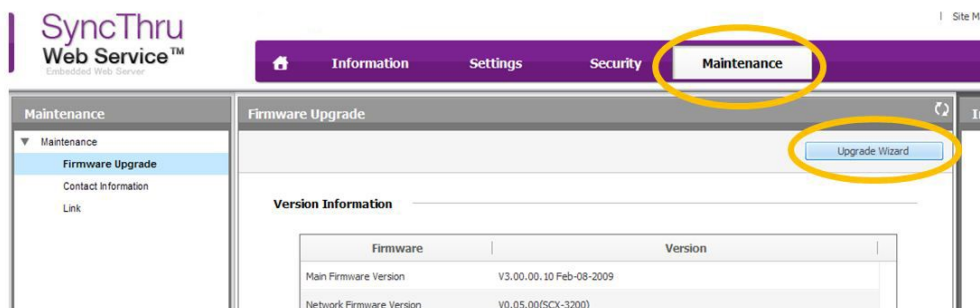

4. Alignment and Troubleshooting

- 4) Select firmware file using “browser” button and press next button.

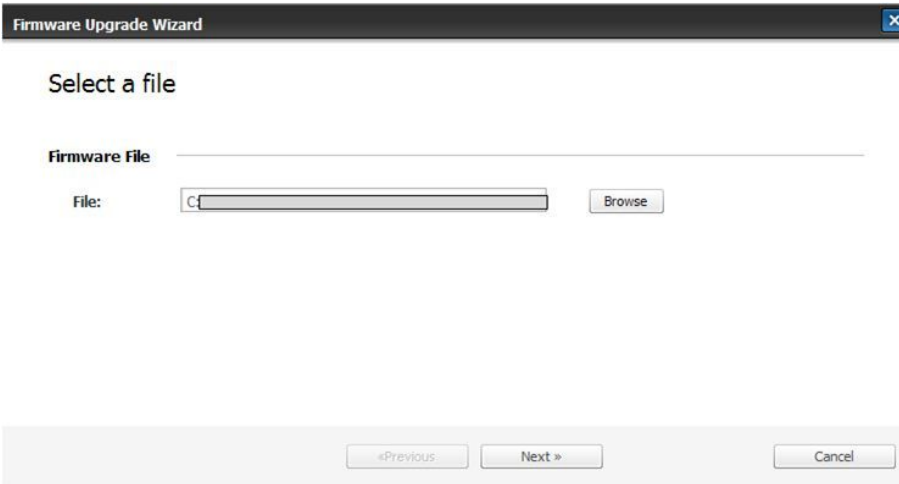

- 5) SyncThru will check verify firmware file and compare version and press next button.

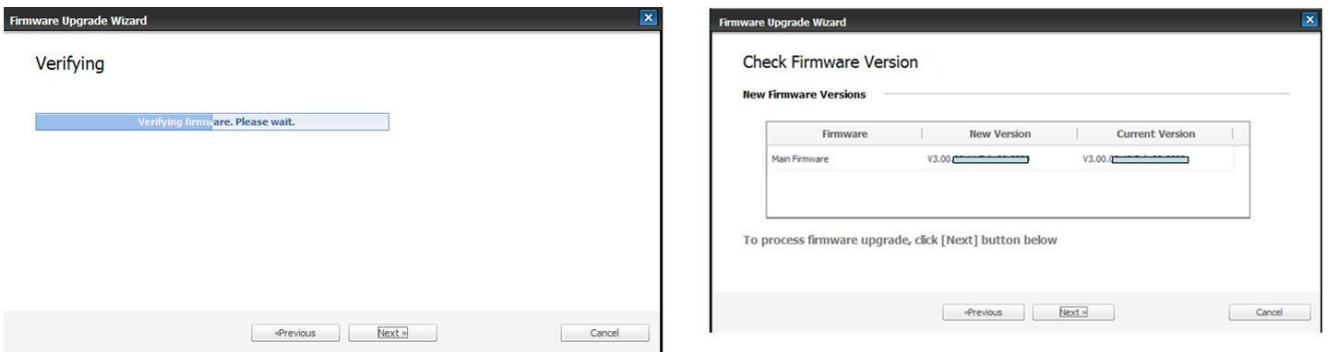

- 6) Machine starts upgrading. SyncThru will return home page after upgrading is completed.

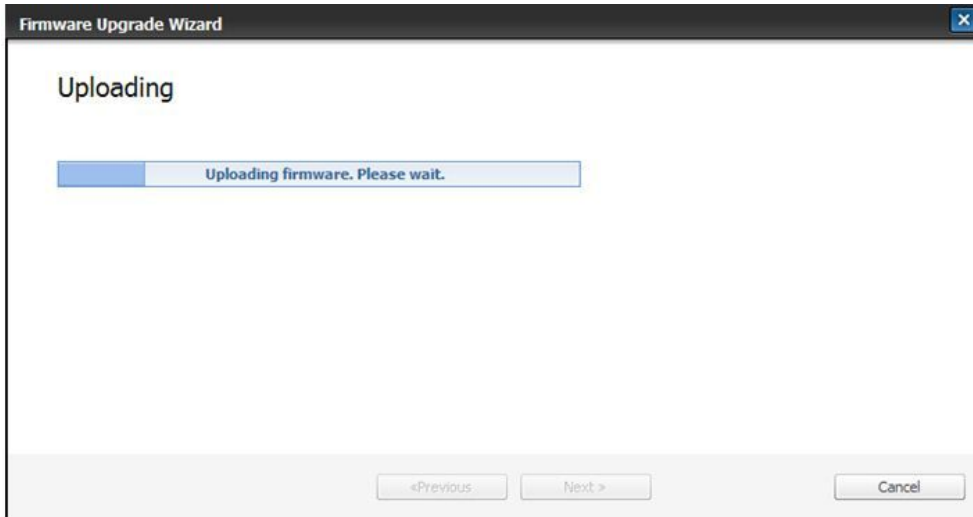

4.2. Troubleshooting

4.2.1. Procedure of checking the symptoms

Before attempting to repair the printer first obtain a detailed description of the problem from the customer.

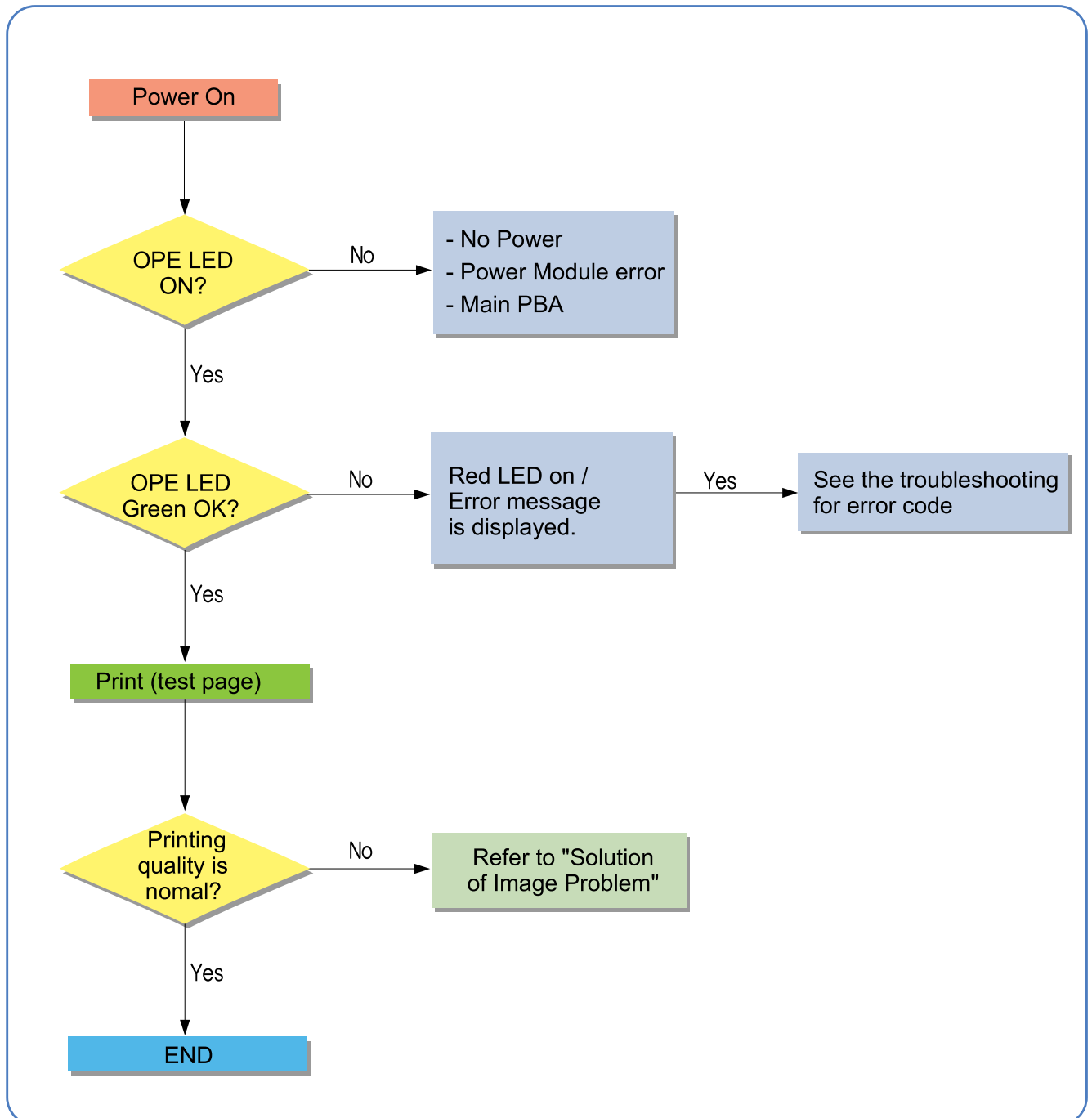

4.2.1.1. Basic Check List

1) **Check the Power.**

- Check that the power switch is turned on.
- Check that the power cable is plugged into the outlet and the printer.
- Check the voltage of the power outlet.

2) **Check the LED of Panel.**

- Is there OPE LED ON?
 - › If not check power cable, switch SMPS or Main board.
- Is the abnormal Lamp?
 - › Check the Main board and cable harness.

3) **Check the Paper Path**

- Is there a Paper Jam?
 - › Remove any paper fragments caught in the paper path.
- Paper Jam occurs repeatedly at a specific point in the Paper Path
 - › Open the fuser cover, Jam clear.
 - › Dismantle the machine and carefully inspect the region where the jam occurs.
(Especially, check if paper fragments are caught in the Fuser)

4) **Print the Information Page (Configuration).**

- Try printing a test page from a computer.
 - › If there is an error check cables and driver installation.

5) **Check the Print Quality.**

- Is there are a Print Quality Problem?
 - › Refer to image quality problem section.

6) **Check consumables (toner etc.).**

- Using the keys print the Test Pattern.
 - › Expected life of various consumable parts, compare this with the figures printed and replace as required

4.2.2. Error Code and Troubleshooting

Error in machine can be checked through “Event Log Information” report.

Error Code	Error Message	Troubleshooting
C2-1110	Prepare new toner cartridge.	Page 4-19
C2-1120	Replace with new toner cartridge.	Page 4-19
C2-1140	End of life, Replace with new toner cartridge.	Page 4-19
C2-1410	Toner cartridge is not installed. Install the cartridge.	Page 4-19
C2-1510	Toner cartridge is not compatible. Check user's guide.	Page 4-20
C2-1710	Toner Cartridge Failure: #C2-1710. Call for service	Page 4-19
C2-1711	Toner Cartridge Failure: #C2-1711. Call for service	Page 4-19
C2-1712	Toner Cartridge Failure: #C2-1712. Call for service	Page 4-19
M2-1110	Paper jam inside of machine.	Page 4-20
M2-1116	Paper jam or empty in tray	Page 4-20
M2-1317	Paper jam inside of machine	Page 4-21
S1-5221	Wireless network card is not installed. Install the card.	Page 4-21
S2-4110	Door is open. Close it.	Page 4-22
S6-3123	This IP address conflicts with that of other system. Check it.	Page 4-22
U1-2320	Fuser Unit Failure #U1-2320. Turn off then on.	Page 4-23
U1-2330	Fuser Unit Failure #U1-2330. Turn off then on.	Page 4-23
U1-2340	Fuser Unit Failure #U1-2340. Turn off then on.	Page 4-23
U2-1112	LSU Unit Failure: #U2-1112. Turn off then on.	Page 4-24
U2-1113	LSU Unit Failure: #U2-1113. Turn off then on.	Page 4-24

▶ **Error Code**

C2-1110

C2-1120

C2-1140

▶ **Error message**

Prepare new toner cartridge.

Replace with new toner cartridge.

End of life, Replace with new toner cartridge.

▶ **Symptom**

The remaining toner cartridge is less than 10% / The toner cartridge is at the end of its life.

▶ **Troubleshooting method**

Print the supply information report.

Check the life remaining of the toner cartridge.

If its life is at the end, turn the machine off and replace the toner cartridge with new one.

▶ **Error Code**

C2-1410

C2-1710

C2-1711

C2-1712

▶ **Error message**

Toner cartridge is not installed. Install the cartridge.

Toner Cartridge Failure: #C2-1710. Call for service

Toner Cartridge Failure: #C2-1711 Call for service

Toner Cartridge Failure: #C2-1712. Call for service

▶ **Symptom**

The toner cartridge is not installed. / The machine can't detect the toner cartridge.

▶ **Troubleshooting method**

- 1) Check if the toner cartridge is installed. If it is OK, turn the machine off then on.
- 2) If the error message is not disappear, remove the toner cartridge. Thoroughly roll the cartridge five or six times to distribute the toner evenly inside the cartridge. And reinstall the toner cartridge.
- 3) If the problem persists, check that the CRUM contact area is contaminated. Clean it.



- 4) If the problem persists, replace the toner cartridge with new one.

▶ **Error Code**

C2-1510

▶ **Error message**

Toner cartridge is not compatible. Check users guide.

▶ **Symptom**

Toner cartridge is not compatible.

▶ **Troubleshooting method**

- 1) Print the supply information report. Check information of the toner cartridge.
- 2) If the toner cartridge is not a Samsung genuine toner cartridge, replace it with new one.

▶ **Error Code**

M2-1110

M2-1116

▶ **Error message**

Paper jam inside of machine.

Paper jam or empty in tray

▶ **Symptom**

A paper jam was detected at the feed sensor.

▶ **Troubleshooting method**

- 1) Check if paper is on tray.
- 2) Remove the jammed paper. (Refer to 4.1.3 Jam removal)
- 3) If the jammed paper occurs continually, check the followings.
 - a) Check if the pick up rubber or friction pad is worn out or contaminated. Clean the contaminated part or replace it.

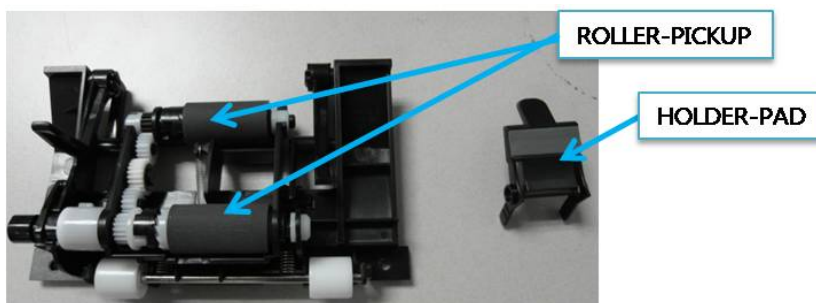

- b) Check if the connector is connected to the feed sensor PBA correctly.
- c) Check if the actuator is assembled correctly.
- d) If the connection and actuator are OK, replace the feed sensor PBA.

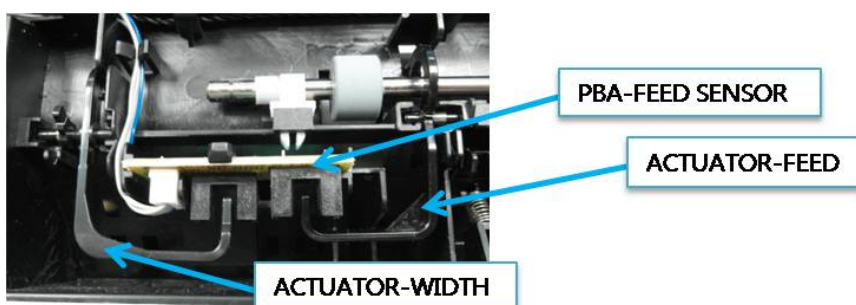

▶ **Error Code**

M2-1317

▶ **Error message**

Paper jam inside of machine.

▶ **Symptom**

A paper jam was detected in the fuser unit area.

▶ **Troubleshooting method**

- 1) Open the top cover. Remove the jammed paper.
- 2) Turn the machine off.
- 3) Turn the machine on while pushing the print screen button. (wireless model : WPS button) Wait for rebooting the machine.

▶ **Error Code**

S1-5221

▶ **Error message**

Wireless network card is not installed. Install the card.

▶ **Symptom**

The communication error between the main board and the wireless board has occurred.

▶ **Troubleshooting method**

- 1) Check if the connection between the main board and the wireless board is normal.

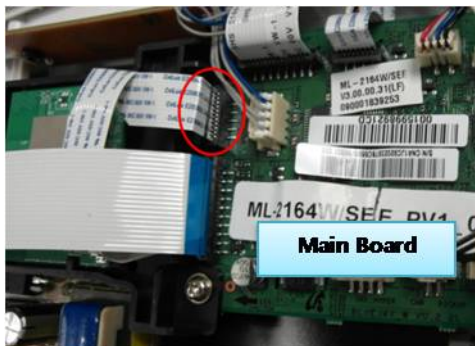

- 2) If the connection is OK, replace the flat cable.
- 3) If the flat cable is OK, replace the WLAN board.
- 4) If the problem persists after replacing the WLAN board, replace the main board.

▶ Error Code

S2-4110

▶ Error message

Door is open. Close it.

▶ Symptom

Top cover is open or the cover open switch is defective.

▶ Troubleshooting method

- 1) Check if the top cover is closed perfectly. Open and close it.
- 2) Remove the right cover. Check if the connection between the main board and SMPS/HVPS board is correct.
- 3) Check if the cover open switch on SMPS/HVPS board is operated properly. If it is defective, replace the SMPS/HVPS board.

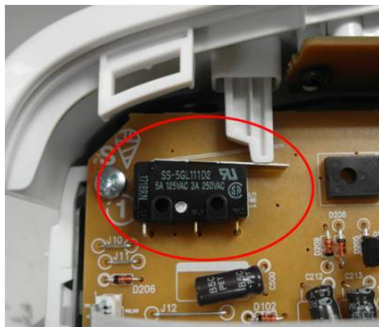
**▶ Error Code**

S6-3123

▶ Error message

This IP address conflicts with that of other system. Check it.

▶ Symptom

Network has some problem. (IP address conflicts with that of other system. / Communication error / There is no response when checking the ping test.)

▶ Troubleshooting method

Change the machine's IP address.

- Execute the Samsung Easy Printer Manager program. (Device setting — Network — IP address). Change the IP address.
- In case of DHCP or Bootp, reboot the machine to receive a new IP address.

▶ **Error Code**

U1-2320

U1-2330

U1-2340

▶ **Error message**

Fuser Unit Failure #U1-2320 : Turn off then on.

Fuser Unit Failure #U1-2330 : Turn off then on.

Fuser Unit Failure #U1-2340 : Turn off then on.

▶ **Symptom**

The temperature control of fuser unit is abnormal. (U1-2320 : Open Heat Error / U1-2330 : Low Heat Error / U1-2340 : Over Heat Error)

▶ **Troubleshooting method**

- 1) Turn the machine off. Re-install the fuser unit. Then turn the machine on. Is the error message is disappeared?
- 2) If the problem persists, turn the machine off and remove the fuser unit.
 - a) Check if the fuser connector is connected properly.
 - b) Check if the input voltage is normal.
 - c) Check if the thermistor is twisted or contaminated.
- 3) After confirming continuity in the fuser connector and the problem still exists; order an SMPS/HVPS and Fuser Unit and install as is necessary.

► Error Code

U2-1112

U2-1113

► Error message

LSU Unit Failure #U2-1112. Turn off then on.

LSU Unit Failure #U2-1113. Turn off then on.

► Symptom

LSU Motor does not work normally.

► Troubleshooting method

- 1) Check if the LSU harness on the main board is connected properly. (picture- 1)
- 2) If it is OK, check that the LSU harness on LSU board is connected properly. (picture- 2,3)
- 3) Check if the LSU harness is defective. (picture- 4,5)
- 4) If the problem persists, replace the LSU.
- 5) If the problem persists after replacing LSU, replace the main board.



4.2.3. Image quality problem

1) Vertical Black Line and Band

Description : Straight thin black vertical line occurs in the printed image.



Check and cause	Solution
<ul style="list-style-type: none"> • Damaged develop roller in the toner cartridge. Deformed Doctor-blade or cleaning-blade. • Scratched surface of the charge roller in the toner cartridge. 	Replace the toner cartridge.
Partly depression or deformation on the surface of the transfer roller.	Replace the transfer roller.

2) Vertical White Line

Description : White vertical voids occurs in the printed image.



Check and cause	Solution
Foreign matter sticks onto the window of internal lenses of LSU mirror.	Clean the LSU window with recommended cleaner (IPA). Clean the window with a clean cotton swab.
The life of the toner cartridge has been expired	Replace the toner cartridge.
Some foreign substances are on the window of the toner cartridge frame.	Remove the foreign matter of the exposure window.
If the fuser is defective, voids occur periodically at the top of a black image.	Replace the fuser unit.

3) **Horizontal Black Band**

Description : Dark or blurry horizontal stripes occur in the printing periodically.



Check and cause	Solution
Bad contacts of the voltage terminals to toner cartridge.	Clean each voltage terminal of the Charge, Developing roller and Transfer roller. (remove the toner particles and paper particles)
The rollers of developer may be stained. — OPC Drum = 62.9 mm — Developing roller = 33.7 mm — Charge roller = 26.7 mm	Replace the toner cartridge.

4) **Black and White spot**

Description : Dark or blurry black spots occur periodically in the printing.



Check and cause	Solution
If dark or blurry black spots occur periodically, the rollers in the toner cartridge may be contaminated with foreign matter or paper particles. (Charge roller : 26.7 mm interval / OPC drum : 62.9 mm interval)	Clean each voltage terminal of the Charge, Magnetic, toner cartridge and Transfer roller. (remove the toner particles and paper particles)
If faded areas or voids occur in a black image at intervals of 62.9 mm, the OPC drum surface is damaged.	Replace the toner cartridge.
If a black image is partially broken, the transfer voltage is abnormal or the transfer roller's life has expired.	<ul style="list-style-type: none"> • If the transfer roller's life is expired, replace it. • Clean the inside of the set against the paper particles and foreign matter in order not to cause the trouble.

5) **Light image**

Description : The printed image is light, with no ghost.



Check and cause	Solution
Toner cartridge life is expired.	Replace the toner cartridge.
HVPS terminal is contaminated.	Clean the contaminated terminal.
The output from the HVPS is abnormal.	Replace the HVPS board.

6) **Dark or Black page**

Description : The printed image is dark or black.



Check and cause	Solution
Check if the high voltage terminal is contaminated.	Clean the high voltage terminal.
The charging roller is defective.	Replace the toner cartridge.
The output from the HVPS is abnormal.	Replace the HVPS board.

7) **Uneven Density**

Description : Print density is uneven between left and right.



Check and cause	Solution
<ul style="list-style-type: none"> The pressure force on the left and right springs of the transfer roller is not even. The springs are damaged. The transfer roller is improperly installed. 	<ol style="list-style-type: none"> Remove the transfer roller Assy. Check if the transfer roller Assy has any wrong part. Replace the transfer roller Assy.
The toner level is not even on the toner cartridge roller due to the bad doctor blade.	Replace the toner cartridge.

8) **Background**

Description : Light dark background appears in whole area of the printing.



Check and cause	Solution
Does recycle paper be used?	Use the proper papers.
The life of the toner cartridge has been expired	Replace the toner cartridge.
The output from the HVPS is abnormal.	Replace the HVPS board.

9) **Ghost**

Description : Ghost occurs at 62.9 mm intervals of the OPC drum.



Check and cause	Solution
The high voltage terminal is contaminated.	Clean the high voltage terminals.
The life of the toner cartridge has been expired	Replace the toner cartridge.
The life of the transfer roller has been expired.	Replace the transfer roller.

10) **Stains on back of page**

Description : The back of the page is stained.



Check and cause	Solution
Transfer roller is contaminated.	Replace the transfer roller.

11) **Blank page**

Description : The back of the page is stained.



Check and cause	Solution
The ground contact of the toner cartridge is bad.	Clean the ground terminal of the toner cartridge. If the problem persists, replace the toner cartridge.
LSU is defective.	Replace the LSU.
The connection between the main board and HVPS board is bad.	Reconnect the harness. If the main board or HVPS board is defective, replace it.

12) **Partial image void**

Description : The partial void occurs in the printed page.



Check and cause	Solution
The printer is not installed on flat ground.	Install the printer on flat ground. Print 10 sample pages for test.
The developer circulation in the toner cartridge is bad.	1) Shake the toner cartridge 2~3 times from right to left. Reinstall the toner cartridge. Print 10 sample pages for test. 2) If the problem persists, replace the toner cartridge.
The contact between toner cartridge and transfer roller is bad.	Check if the toner cartridge and transfer roller are installed properly.

4.2.4. Other errors

1) Multi-feeding

- Description : Multiple sheet of paper are fed at once.

Check and cause	Solution
Pick clutch does not work properly.	Replace the defective clutch if necessary.
Pick up roller is worn out or contaminated.	Clean or replace the pick up roller.

2) No-Power

- Description : When system power is turned on, LED and LCD on the operator panel do not come on.

Check and cause	Solution
The connection between main board and OPE board is bad.	Reconnect or replace the harness.
HVPS/SMPS output is abnormal.	Replace the HVPS/SMPS board.

5. System Diagram

5.1. Block Diagram

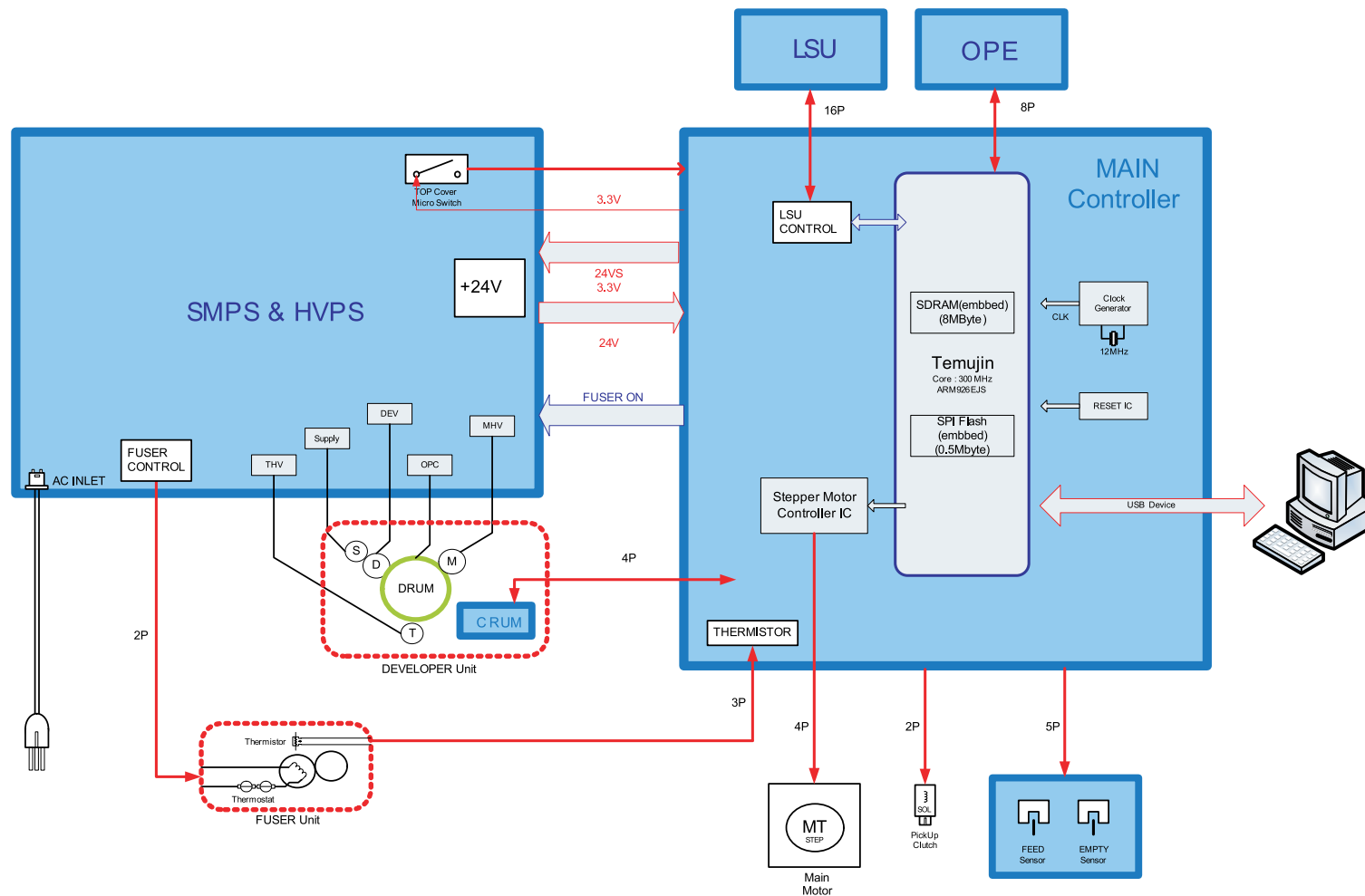

5.2. Connection Diagram

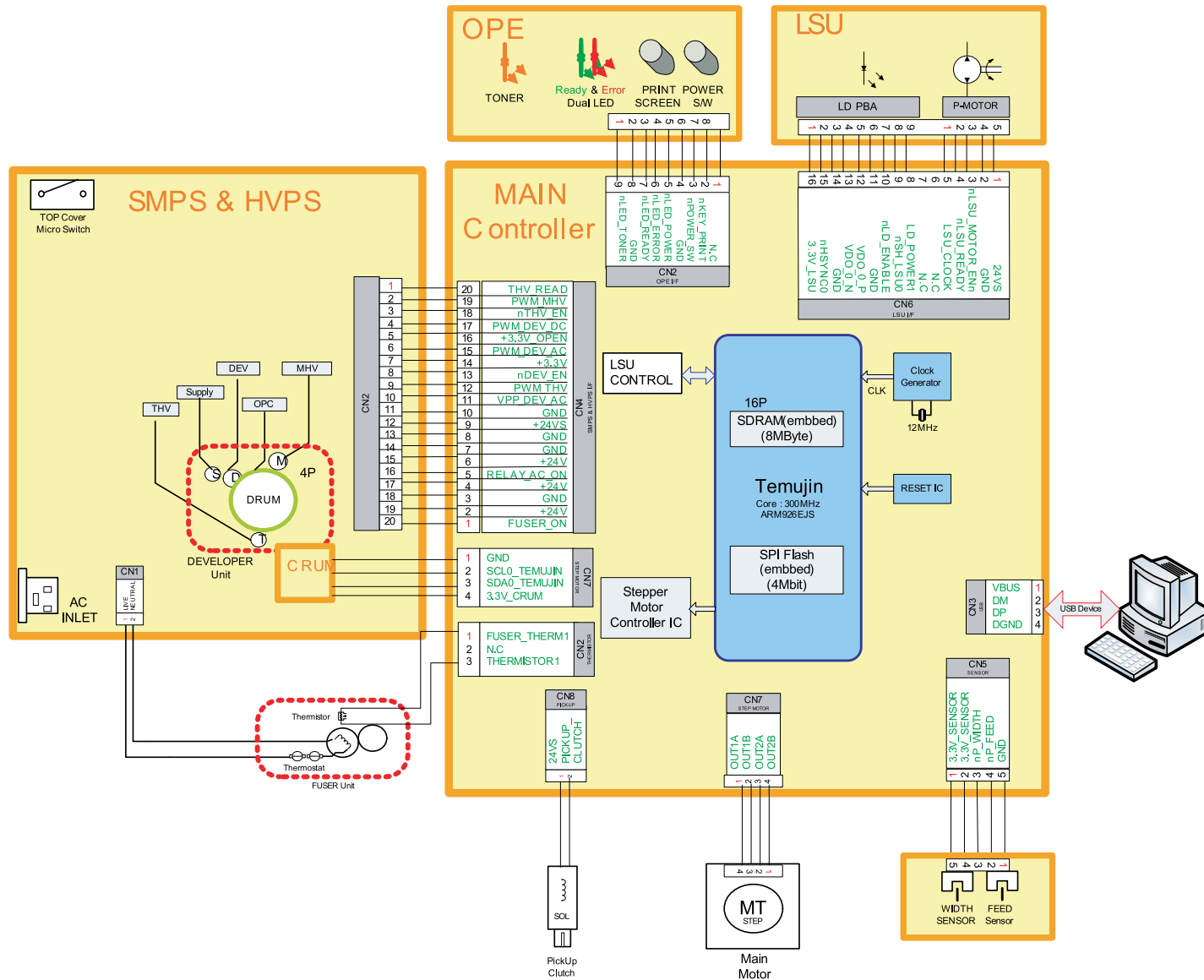





6. Reference Information

This chapter contains the tools list, list of abbreviations used in this manual, and a guide to the location space required when installing the printer. A definition of test pages and Wireless Network information definition is also included.

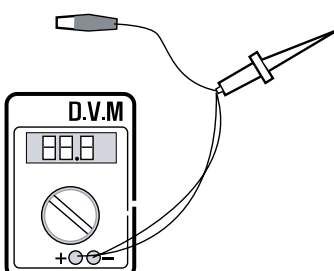
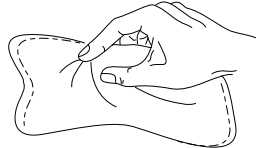
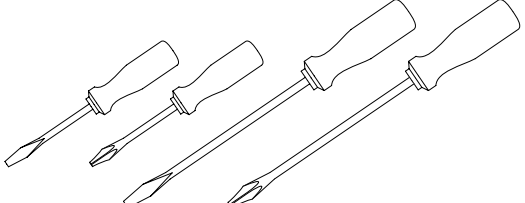
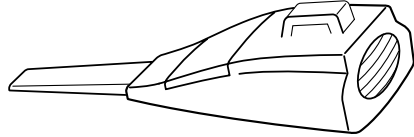
6.1. Tool for Troubleshooting

The following tools are recommended safe and easy troubleshooting as described in this service manual.

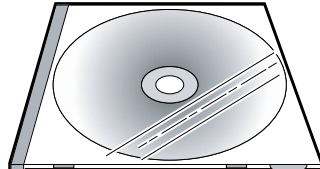
<p>DVM (Digital Volt Meter) Standard : Indicates more than 3 digits.</p> 	<p>Cleaning Equipments Standard : An IPA (Isopropyl Alcohol) dry wipe tissue or a gentle neutral detergent and lint-free cloth.</p> 
<p>Driver Standard : “-” type, “+” type (M3 long, M3 short, M2 long, M2 short).</p> 	<p>Vacuum Cleaner</p> 
<p>Tweezers Standard : For general home use, small type.</p> 	<p>Spring Hook Standard : For general use</p> 
<p>Cotton Swab Standard : For general home use, for medical service.</p> 	<p>Software (Driver) installation CD ROM</p> 

6.2. Glossary

The following glossary helps you get familiar with the product by understanding the terminologies commonly used with printing as well as mentioned in this user's guide and service manual.

802.11	802.11 is a set of standards for wireless local area network (WLAN) communication, developed by the IEEE LAN/MAN Standards Committee (IEEE 802).
802.11b/g/n	802.11b/g/n can share same hardware and use the 2.4 GHz band. 802.11b supports bandwidth up to 11 Mbps, 802.11n supports bandwidth up to 150 Mbps. 802.11b/g/n devices may occasionally suffer interference from microwave ovens, cordless telephones, and Bluetooth devices.
Access point	Access Point or Wireless Access Point (AP or WAP) is a device that connects wireless communication devices together on wireless local area networks (WLAN), and acts as a central transmitter and receiver of WLAN radio signals.
ADF	An Automatic Document Feeder (ADF) is a scanning unit that will automatically feed an original sheet of paper so that the machine can scan some amount of the paper at once.
AppleTalk	AppleTalk is a proprietary suite of protocols developed by Apple, Inc for computer networking. It was included in the original Macintosh (1984) and is now deprecated by Apple in favor of TCP/IP networking.
BIT Depth	A computer graphics term describing the number of bits used to represent the color of a single pixel in a bitmapped image. Higher color depth gives a broader range of distinct colors. As the number of bits increases, the number of possible colors becomes impractically large for a color map. 1-bit color is commonly called as monochrome or black and white.
BMP	A bitmapped graphics format used internally by the Microsoft Windows graphics subsystem (GDI), and used commonly as a simple graphics file format on that platform.
BOOTP	Bootstrap Protocol. A network protocol used by a network client to obtain its IP address automatically. This is usually done in the bootstrap process of computers or operating systems running on them. The BOOTP servers assign the IP address from a pool of addresses to each client. BOOTP enables 'diskless workstation' computers to obtain an IP address prior to loading any advanced operating system.
CCD	Charge Coupled Device (CCD) is a hardware which enables the scan job. CCD Locking mechanism is also used to hold the CCD module to prevent any damage when you move the machine.
Collation	Collation is a process of printing a multiple-copy job in sets. When collation is selected, the device prints an entire set before printing additional copies.
Control Panel	A control panel is a flat, typically vertical, area where control or monitoring instruments are displayed. They are typically found in front of the machine.
Coverage	It is the printing term used for a toner usage measurement on printing. For example, 5% coverage means that an A4 sided paper has about 5% image or text on it. So, if the paper or original has complicated images or lots of text on it, the coverage will be higher and at the same time, a toner usage will be as much as the coverage.
CSV	Comma Separated Values (CSV). A type of file format, CSV is used to exchange data between disparate applications. The file format, as it is used in Microsoft Excel, has become a de facto standard throughout the industry, even among non-Microsoft platforms.
DADF	A Duplex Automatic Document Feeder (DADF) is a scanning unit that will automatically feed and turn over an original sheet of paper so that the machine can scan on both sides of the paper.
Default	The value or setting that is in effect when taking a printer out of its box state, reset, or initialized.
DHCP	A Dynamic Host Configuration Protocol (DHCP) is a client-server networking protocol. A DHCP server provides configuration parameters specific to the DHCP client host requesting, generally, information required by the client host to participate on an IP network. DHCP also provides a mechanism for allocation of IP addresses to client hosts.
DIMM	Dual Inline Memory Module (DIMM), a small circuit board that holds memory. DIMM stores all the data within the machine like printing data, received fax data.

DLNA	The Digital Living Network Alliance (DLNA) is a standard that allows devices on a home network to share information with each other across the network.
DNS	The Domain Name Server (DNS) is a system that stores information associated with domain names in a distributed database on networks, such as the Internet.
Dot Matrix Printer	A dot matrix printer refers to a type of computer printer with a print head that runs back and forth on the page and prints by impact, striking an ink-soaked cloth ribbon against the paper, much like a typewriter.
DPI	Dots Per Inch (DPI) is a measurement of resolution that is used for scanning and printing. Generally, higher DPI results in a higher resolution, more visible detail in the image, and a larger file size.
DRPD	Distinctive Ring Pattern Detection. Distinctive Ring is a telephone company service which enables a user to use a single telephone line to answer several different telephone numbers.
Duplex	A mechanism that will automatically turn over a sheet of paper so that the machine can print (or scan) on both sides of the paper. A printer equipped with a Duplex Unit can print on both sides of paper during one print cycle.
Duty Cycle	Duty cycle is the page quantity which does not affect printer performance for a month. Generally the printer has the lifespan limitation such as pages per year. The lifespan means the average capacity of print-outs, usually within the warranty period. For example, if the duty cycle is 48,000 pages per month assuming 20 working days, a printer limits 2,400 pages a day.
ECM	Error Correction Mode (ECM) is an optional transmission mode built into Class 1 fax machines or fax modems. It automatically detects and corrects errors in the fax transmission process that are sometimes caused by telephone line noise.
Emulation	Emulation is a technique of one machine obtaining the same results as another. An emulator duplicates the functions of one system with a different system, so that the second system behaves like the first system. Emulation focuses on exact reproduction of external behavior, which is in contrast to simulation, which concerns an abstract model of the system being simulated, often considering its internal state.
Ethernet	Ethernet is a frame-based computer networking technology for local area networks (LANs). It defines wiring and signaling for the physical layer, and frame formats and protocols for the media access control (MAC)/data link layer of the OSI model. Ethernet is mostly standardized as IEEE 802.3. It has become the most widespread LAN technology in use during the 1990s to the present.
EtherTalk	A suite of protocols developed by Apple Computer for computer networking. It was included in the original Macintosh (1984) and is now deprecated by Apple in favor of TCP/IP networking.
FDI	Foreign Device Interface (FDI) is a card installed inside the machine to allow a third party device such as a coin operated device or a card reader. Those devices allow the pay-for-print service on your machine.
FTP	A File Transfer Protocol (FTP) is a commonly used protocol for exchanging files over any network that supports the TCP/IP protocol (such as the Internet or an intranet).
Fuser Unit	The part of a laser printer that fuses the toner onto the print media. It consists of a heat roller and a pressure roller. After toner is transferred onto the paper, the fuser unit applies heat and pressure to ensure that the toner stays on the paper permanently, which is why paper is warm when it comes out of a laser printer.
Gateway	A connection between computer networks, or between a computer network and a telephone line. It is very popular, as it is a computer or a network that allows access to another computer or network.
Grayscale	A shades of gray that represent light and dark portions of an image when color images are converted to grayscale; colors are represented by various shades of gray.
Halftone	An image type that simulates grayscale by varying the number of dots. Highly colored areas consist of a large number of dots, while lighter areas consist of a smaller number of dots.
HDD	Hard Disk Drive (HDD), commonly referred to as a hard drive or hard disk, is a non-volatile storage device which stores digitally-encoded data on rapidly rotating platters with magnetic surfaces.

IEEE	The Institute of Electrical and Electronics Engineers (IEEE) is an international non-profit, professional organization for the advancement of technology related to electricity.
IEEE 1284	The 1284 parallel port standard was developed by the Institute of Electrical and Electronics Engineers (IEEE). The term "1284-B" refers to a specific connector type on the end of the parallel cable that attaches to the peripheral (for example, a printer).
Intranet	A private network that uses Internet Protocols, network connectivity, and possibly the public telecommunication system to securely share part of an organization's information or operations with its employees. Sometimes the term refers only to the most visible service, the internal website.
IP address	An Internet Protocol (IP) address is a unique number that devices use in order to identify and communicate with each other on a network utilizing the Internet Protocol standard.
IPM	The Images Per Minute (IPM) is a way of measuring the speed of a printer. An IPM rate indicates the number of single-sided sheets a printer can complete within one minute.
IPP	The Internet Printing Protocol (IPP) defines a standard protocol for printing as well as managing print jobs, media size, resolution, and so forth. IPP can be used locally or over the Internet to hundreds of printers, and also supports access control, authentication, and encryption, making it a much more capable and secure printing solution than older ones.
IPX/SPX	IPX/SPX stands for Internet Packet Exchange/Sequenced Packet Exchange. It is a networking protocol used by the Novell NetWare operating systems. IPX and SPX both provide connection services similar to TCP/IP, with the IPX protocol having similarities to IP, and SPX having similarities to TCP. IPX/SPX was primarily designed for local area networks (LANs), and is a very efficient protocol for this purpose (typically its performance exceeds that of TCP/IP on a LAN).
ISO	The International Organization for Standardization (ISO) is an international standard-setting body composed of representatives from national standards bodies. It produces world-wide industrial and commercial standards.
ITU-T	The International Telecommunication Union is an international organization established to standardize and regulate international radio and telecommunications. Its main tasks include standardization, allocation of the radio spectrum, and organizing interconnection arrangements between different countries to allow international phone calls. A -T out of ITU-T indicates telecommunication.
ITU-T No. 1 chart	Standardized test chart published by ITU-T for document facsimile transmissions.
JBIG	Joint Bi-level Image Experts Group (JBIG) is an image compression standard with no loss of accuracy or quality, which was designed for compression of binary images, particularly for faxes, but can also be used on other images.
JPEG	Joint Photographic Experts Group (JPEG) is a most commonly used standard method of lossy compression for photographic images. It is the format used for storing and transmitting photographs on the World Wide Web.
LDAP	The Lightweight Directory Access Protocol (LDAP) is a networking protocol for querying and modifying directory services running over TCP/IP.
LED	A Light-Emitting Diode (LED) is a semiconductor device that indicates the status of a machine.
MAC address	Media Access Control (MAC) address is a unique identifier associated with a network adapter. MAC address is a unique 48-bit identifier usually written as 12 hexadecimal characters grouped in pairs (e. g., 00-00-0c-34-11-4e). This address is usually hard-coded into a Network Interface Card (NIC) by its manufacturer, and used as an aid for routers trying to locate machines on large networks.
MFP	Multi Function Peripheral (MFP) is an office machine that includes the following functionality in one physical body, so as to have a printer, a copier, a fax, a scanner and etc.
MH	Modified Huffman (MH) is a compression method for decreasing the amount of data that needs to be transmitted between the fax machines to transfer the image recommended by ITU-T T.4. MH is a codebook-based run-length encoding scheme optimized to efficiently compress white space. As most faxes consist mostly of white space, this minimizes the transmission time of most faxes.
MMR	Modified Modified READ (MMR) is a compression method recommended by ITU-T T.6.

Modem	A device that modulates a carrier signal to encode digital information, and also demodulates such a carrier signal to decode transmitted information.
MR	Modified Read (MR) is a compression method recommended by ITUT T.4. MR encodes the first scanned line using MH. The next line is compared to the first, the differences determined, and then the differences are encoded and transmitted.
NetWare	A network operating system developed by Novell, Inc. It initially used cooperative multitasking to run various services on a PC, and the network protocols were based on the archetypal Xerox XNS stack. Today NetWare supports TCP/IP as well as IPX/SPX.
OPC	Organic Photo Conductor (OPC) is a mechanism that makes a virtual image for print using a laser beam emitted from a laser printer, and it is usually green or rust colored and has a cylinder shape. An imaging unit containing a drum slowly wears the drum surface by its usage in the printer, and it should be replaced appropriately since it gets worn from contact with the cartridge development brush, cleaning mechanism, and paper.
Originals	The first example of something, such as a document, photograph or text, etc, which is copied, reproduced or translated to produce others, but which is not itself copied or derived from something else.
OSI	Open Systems Interconnection (OSI) is a model developed by the International Organization for Standardization (ISO) for communications. OSI offers a standard, modular approach to network design that divides the required set of complex functions into manageable, self-contained, functional layers. The layers are, from top to bottom, Application, Presentation, Session, Transport, Network, Data Link and Physical.
PABX	A private automatic branch exchange (PABX) is an automatic telephone switching system within a private enterprise.
PCL	Printer Command Language (PCL) is a Page Description Language (PDL) developed by HP as a printer protocol and has become an industry standard. Originally developed for early inkjet printers, PCL has been released in varying levels for thermal, dot matrix printer, and laser printers.
PDF	Portable Document Format (PDF) is a proprietary file format developed by Adobe Systems for representing two dimensional documents in a device independent and resolution independent format.
PostScript(PS)	PostScript (PS) is a page description language and programming language used primarily in the electronic and desktop publishing areas. - that is run in an interpreter to generate an image.
Printer Driver	A program used to send commands and transfer data from the computer to the printer.
Print Media	The media like paper, envelopes, labels, and transparencies which can be used in a printer, a scanner, a fax or, a copier.
PPM	Pages Per Minute (PPM) is a method of measurement for determining how fast a printer works, meaning the number of pages a printer can produce in one minute.
PRN file	An interface for a device driver, this allows software to interact with the device driver using standard input/output system calls, which simplifies many tasks.
Protocol	A convention or standard that controls or enables the connection, communication, and data transfer between two computing endpoints.
PSTN	The Public-Switched Telephone Network (PSTN) is the network of the world's public circuit-switched telephone networks which, on industrial premises, is usually routed through the switchboard.
RADIUS	Remote Authentication Dial In User Service (RADIUS) is a protocol for remote user authentication and accounting. RADIUS enables centralized management of authentication data such as usernames and passwords using an AAA (authentication, authorization, and accounting) concept to manage network access.
Resolution	The sharpness of an image, measured in Dots Per Inch (DPI). The higher the dpi, the greater the resolution.
SMB	Server Message Block (SMB) is a network protocol mainly applied to share files, printers, serial ports, and miscellaneous communications between nodes on a network. It also provides an authenticated Interprocess communication mechanism.

SMTP	Simple Mail Transfer Protocol (SMTP) is the standard for e-mail transmissions across the Internet. SMTP is a relatively simple, text based protocol, where one or more recipients of a message are specified, and then the message text is transferred. It is a client server protocol, where the client transmits an email message to the server.
SSID	Service Set Identifier (SSID) is a name of a wireless local area network (WLAN). All wireless devices in a WLAN use the same SSID in order to communicate with each other. The SSIDs are case-sensitive and have a maximum length of 32 characters.
Subnet Mask	The subnet mask is used in conjunction with the network address to determine which part of the address is the network address and which part is the host address.
TCP/IP	The Transmission Control Protocol (TCP) and the Internet Protocol (IP); the set of communications protocols that implement the protocol stack on which the Internet and most commercial networks run.
TCR	Transmission Confirmation Report (TCR) provides details of each transmission such as job status, transmission result and number of pages sent. This report can be set to print after each job or only after failed transmissions.
TIFF	Tagged Image File Format (TIFF) is a variable-resolution bitmapped image format. TIFF describes image data that typically come from scanners. TIFF images make use of tags, keywords defining the characteristics of the image that is included in the file. This flexible and platform-independent format can be used for pictures that have been made by various image processing applications.
Toner Cartridge	A kind of bottle or container used in a machine like a printer which contains toner. Toner is a powder used in laser printers and photocopiers, which forms the text and images on the printed paper. Toner can be fused by a combination of heat/pressure from the fuser, causing it to bind to the fibers in the paper.
TWAIN	An industry standard for scanners and software. By using a TWAIN-compliant scanner with a TWAIN-compliant program, a scan can be initiated from within the program. It is an image capture API for Microsoft Windows and Apple Macintosh operating systems.
UNC Path	Uniform Naming Convention (UNC) is a standard way to access network shares in Window NT and other Microsoft products. The format of a UNC path is: \\<servername>\<sharename>\<Additional directory>
URL	Uniform Resource Locator (URL) is the global address of documents and resources on the Internet. The first part of the address indicates what protocol to use, the second part specifies the IP address or the domain name where the resource is located.
USB	Universal Serial Bus (USB) is a standard that was developed by the USB Implementers Forum, Inc., to connect computers and peripherals. Unlike the parallel port, USB is designed to concurrently connect a single computer USB port to multiple peripherals.
Watermark	A watermark is a recognizable image or pattern in paper that appears lighter when viewed by transmitted light. Watermarks were first introduced in Bologna, Italy in 1282; they have been used by papermakers to identify their product, and also on postage stamps, currency, and other government documents to discourage counterfeiting.
WEP	Wired Equivalent Privacy (WEP) is a security protocol specified in IEEE 802.11 to provide the same level of security as that of a wired LAN. WEP provides security by encrypting data over radio so that it is protected as it is transmitted from one end point to another.
WIA	Windows Imaging Architecture (WIA) is an imaging architecture that is originally introduced in Windows Me and Windows XP. A scan can be initiated from within these operating systems by using a WIA-compliant scanner.
WPA	Wi-Fi Protected Access (WPA) is a class of systems to secure wireless (Wi-Fi) computer networks, which was created to improve upon the security features of WEP.
WPA-PSK	WPA-PSK (WPA Pre-Shared Key) is special mode of WPA for small business or home users. A shared key, or password, is configured in the wireless access point (WAP) and any wireless laptop or desktop devices. WPA-PSK generates a unique key for each session between a wireless client and the associated WAP for more advanced security.

WPS	The Wi-Fi Protected Setup (WPS) is a standard for establishing a wireless home network. If your wireless access point supports WPS, you can configure the wireless network connection easily without a computer.
XPS	XML Paper Specification (XPS) is a specification for a Page Description Language (PDL) and a new document format, which has benefits for portable document and electronic document, developed by Microsoft. It is an XML-based specification, based on a new print path and a vector-based device-independent document format.

6.3. The Sample Pattern for the Test

The life of the toner cartridge and the printing speed are measured using the pattern shown below.

Stephen J. Singel
Labanda Sinpat Abarress
Tendar, BSF
URANGLE

23 January 2004

Jonathan Q. Maderia

Inpert Mampem Abareess
2343 Stantin Dawer Lank
Benhibe, SDF

Mr.Maderia:

Nam liber tempor cum soluta nobis eleifend ption cogue nihil consequat, velillum.
Dolore eu zril feugiat nulla acilisis at vero eros accumsan et iusto odio dignis sim qui blandit
praesent lutatum ril lobortis nisl ut aliquip exea commodo consequat. Duis autem vel eum ireund
dolor in hendreritin vulputate velit esse molestie tincidunt ut laoreet dolore magna aliquam erat
volutpat. Ut wisi enim ad minim veniam, quis nostrud exerci tation ullam corpersus cipit lotis nisl
ut aliquip ex ea commodo consequat. Lorem ipsum dolor sit.

Amet, consectetuer adipiscing elit, sud diam nonummy nibh veniam,
recneps adipiscing elit, sed diam nonummy nibtil laoreet dolore mag
aliam erat volutpat. Ut wisi enim minim veniam, quisient nostrud. Sol
uta nobis eleifendoptn cogue nihil imerdiet domg id quod mzim plera
facer posim aum. Lorem ipsm dolor sit amet, consectuer. Duis autem
eum iriure dolor in hendreritin vulputate velit cesse ea commodo mol

Category	Value
B	High
C	Medium-High
D	Medium-Low
E	Low

Nam liber tempor cum soluta nobis eleifend option cogue nihil consequat, B C D E
velillum. Dolore eu zril feugiat nulla facilisis at vero eros accumsan et iusto odio dignissim qui blandit
praesent.

Singabet,

Stephen J. Singel
Demperta Aminerimum
Labanda Sinpat Abarress

SJS:dwg
FINAL

6.4. Selecting a location

Select a level, stable place with adequate space for air circulation. Allow extra space for opening covers and trays.

The area should be well-ventilated and away from direct sunlight or sources of heat, cold, and humidity. Do not set the machine close to the edge of your desk or table.

Clearance space

- Front: 326 mm (enough space so that the paper tray can be removed)
- Back: 100 mm (enough space for ventilation)
- Right: 100 mm (enough space for ventilation)
- Left: 100 mm (enough space for ventilation)



GSPN (GLOBAL SERVICE PARTNER NETWORK)

Area	Web Site
Europe, MENA, CIS, Africa	https://gspn1.samsungcsportal.com
E.Asia, W.Asia, China, Japan	https://gspn2.samsungcsportal.com
N.America, S.America	https://gspn3.samsungcsportal.com

This Service Manual is a property of Samsung Electronics Co.,Ltd.
Any unauthorized use of Manual can be punished under applicable International and/or domestic law.

© 2011 Samsung Electronics Co.,Ltd.
All rights reserved.
Printed in Korea